

MIL-HDBK-161A

DEPARTMENT OF THE ARMY TECHNICAL MANUAL  
DEPARTMENT OF THE NAVY PUBLICATION  
DEPARTMENT OF THE AIR FORCE TECHNICAL ORDER

TM 11-487A-2  
NAVEXOS P-2058  
TO 31-3-73

MILITARY STANDARDIZATION HANDBOOK

ELECTRONIC COMMUNICATION  
EQUIPMENT



2nd Increment to MIL-HDBK-161A, 12 March 1964

FSC MISC

DEPARTMENTS OF THE ARMY AND THE NAVY  
WASHINGTON, D. C., 12 March 1964

This Military Handbook is issued for the use of all concerned.  
By Order of the Secretaries of the Army and the Navy:

HAROLD K. JOHNSON,  
*General, United States Army,  
Chief of Staff.*

Official:

J. C. LAMBERT,  
*Major General, United States Army,  
The Adjutant General.*

W. A. SCHOECH,  
*Vice Admiral, United States Navy,  
Chief of Naval Material.*

Distribution:

Active Army:

USASA (2)	Blue Grass Army Dep (1)	USACDCCAG (1)
CNGB (3)	Charleston Army Dep (2)	USACECDA (Ft Huachuca) (1)
CofEngrs (10)	Utah Army Dep (1)	USACECDA (Ft Monmouth) (1)
CC-E (10)	Columbus Army Dep (1)	USACDCEA (1)
CofT (10)	Erie Army Dep (1)	USACDCEA (1)
USAARTYBD (2)	Ft Wingate Army Dep (1)	USACDCIA (1)
USARADB (2)	Savanna Army Dep (1)	USACDCINTA (1)
USAAESWBD (2)	Granite City Army Dep (1)	USACDCSWA (1)
USAIB (2)	Memphis Army Dep (1)	USACDCTA (1)
USAMB (2)	Schenectady Army Dep (1)	USACDCQMA (1)
USAECOM (50)	Pueblo Army Dep (1)	USACDCOA (1)
USAMC (10)	Navajo Army Dep (1)	USACDCCBRA (1)
USASMC (20)	New Cumberland Army Dep (1)	USAELRDL (24)
USAMICOM (10)	Red River Army Dep (1)	Harry Diamond Lab (2)
USAMUCOM (10)	Seneca Army Dep (1)	Natick Lab (4)
USAWECOM (10)	Sierra Army Dep (1)	USAERDL (2)
USATECOM (10)	Sioux Army Dep (1)	USA CBR Lab (1)
USAMOCOM (10)	Tooele Army Dep (1)	WSMR (2)
USCONARC (10)	Umatilla Army Dep (1)	Birmingham Proc Dist (1)
ARADCOM (2)	USASCC (2)	Birmingham Orlando Br Proc Dist (1)
OS Maj Comd (4)	USAAVNC (4)	Boston Proc Dist (1)
LOGCOMD (2)	WRAMC (1)	Boston Springfield Off Proc Dist (1)
Armies (2) except First USA (4)	USAADC (1)	Chicago Proc Dist (1)
Ft Mason (2)	BAMC (1)	Cincinnati Proc Dist (1)
Ft McClellan (2)	USAATC (1)	Cleveland Proc Dist (1)
Ft Ord (2)	USAEMSA (100)	Detroit Proc Dist (1)
Ft Bragg (2)	USA Elct Mat Agcy (100)	Los Angeles Proc Dist (1)
Ft Shafter (1)	USAADEA (1)	New York Proc Dist (1)
USMA (2)	Brooklyn Army Tml (2)	New York Rochester Ofc Proc Dist (1)
USACGSC (4)	Boston Army Tml (2)	Philadelphia Proc Dist (1)
USAAMS (6)	New Orleans Army Tml (2)	St Louis Proc Dist (1)
USAADS (4)	Beaver Army Tml (1)	Philadelphia Pittsburgh Ofc Proc Dist (1)
USAIS (6)	Hampton Roads Army Tml (1)	San Francisco Proc Dist (1)
USASCS (10)	Sunny Point Army Tml (1)	Sig Fld Maint Shops (2)
USASESCS (6)	Kings bay Army Tml (1)	Units organized under following TOE's:
USAARMS (6)	Oakland Army Toll (1)	11-5(1) 11-555(1)
Letterkenny Army Dep (2)	APG (2)	11-15(1) 11-558(1)
Sacramento Army Dep (2)	Yuma PG (2)	11-22(1) 11-587(1)
Lexington Army Dep (2)	USEPG (6)	11-55(1) 11-592(1)
Tobyhanna Army Dep (2)	Dugway PG (1)	11-95(1) 11-597(1)
Ft Worth Army Dep (2)	Jefferson PG (1)	11-155(1)
Sharpe Army Dep (3)	Erie PG (1)	
Anniston Dep (1)	USACDCADA (1)	
Atlanta Army Dep (1)	USACDCARMA (1)	
Black Hills Army Dep (1)	USACDCARTYA (1)	
	USACDCAVNA (1)	

NG: State AG (3).

USAR: None.

For explanation of abbreviations used, see AR 320-50.

**MILITARY STANDARDIZATION HANDBOOK  
ELECTRONIC COMMUNICATION EQUIPMENT**

TO ALL ACTIVITIES:

- The following pages of MIL-HDBK-161A are to be added:

<i>Categories</i>	<i>Pages</i>	<i>Date</i>
List of type Indicators -----	237-590	12 March 1964
Item Descriptions -----	237-590	12 March 1964
Appendix B -----	591-592	12 March 1964

- Retain this notice and insert before the Table of Contents.

**(SECOND INCREMENT)  
LIST OF TYPE INDICATORS**

<i>Type Indicator</i>	<i>Page</i>	<i>Type Indicator</i>	<i>Page</i>
AN/FRR -----	237	AN/MRT -----	461
AN/FRT -----	277	AN/MTC -----	471
AN/FSH -----	319	AN/MTQ -----	473
AN/FTC -----	321	AN/PGC -----	475
AN/GCA -----	339	AN/PIP -----	477
AN/GGA -----	341	AN/PIQ -----	479
AN/GGC -----	343	AN/PNH -----	485
AN/GIA -----	347	AN/PRC -----	487
AN/GRA -----	351	AN/PRW -----	507
AN/GRC -----	363	AN/PTA -----	509
AN/GRD -----	411	AN/PTC -----	511
AN/GRR -----	413	AN/PVC -----	515
AN/GRT -----	421	AN/SRA -----	517
AN/GSC -----	429	AN/SRC -----	523
AN/GTA -----	431	AN/SRR -----	541
AN/GTC -----	433	AN/SRT -----	545
AN/GTT -----	435	AN/TCA -----	557
AN/MRC -----	455	AN/TCC -----	559
AN/MRR -----	455		

This increment supersedes that portion of MIL-HDBK-161 (TM 11-487A) 11 June 1959 covering equipment of the AN/FRR- through AN/TCC-type. (See par. 3, initial increment.)

**DIVERSITY RECEIVING EQUIPMENT  
AN/FRR-3( )**

1 Mar 64

Cog. Serv.: USA FSN: 5820-187-3154

USA Line Item No: 613740

	USA	USN	USAF	USMC
<b>STATUS OR TYPE CLASS.:</b>	Obs		L/STd	

**Manufacturer:** Press Wireless Manufacturing Co. Inc.

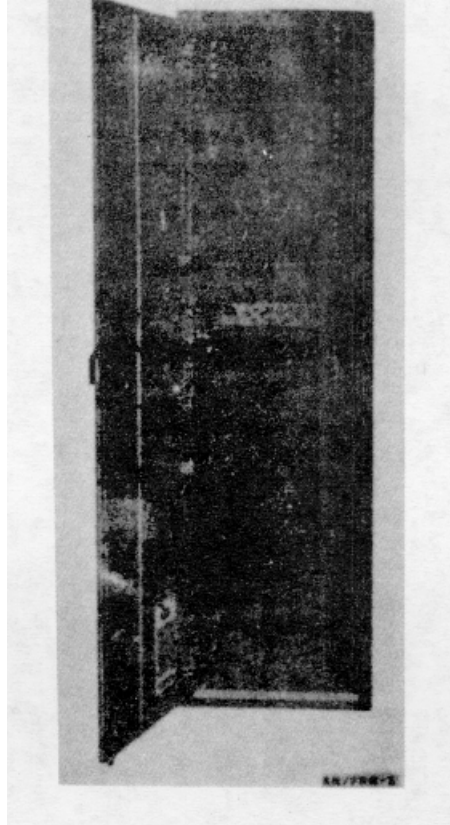
**FUNCTIONAL DESCRIPTION:**

Diversity Receiving Equipment AN/FRR-3( ) is an hf, am (voice and frequency-shift-keying) radio receiving equipment used in long-range, point-to-point communication to overcome the effects of radio fading. It is fixed-plant equipment.

This equipment consists essentially of two identical superheterodyne radio receivers, which operate from separate antennas, and an hf oscillator common to both receivers. Its output can be fed to Radioteletype Terminal Equipment AN/FGC-1.

It is equipped with a telephone dial that may be used to turn the equipment on or off and to select any of five preset frequency channels or any combination of four antennas.

**RELATIONSHIP TO SIMILAR EQUIPMENT:**

None.

**DIVERSITY RECEIVING EQUIPMENT  
AN/FRR-3( )**

**TECHNICAL DESCRIPTION:**

*Frequency Range in mc:* 2.4 to 23 in 5 bands.

*Type Modulation:* am

*Type of Signal:* Voice and FSK radio

*Power Requirements:* 400 w, 100-130/200-260 v 50-60 cy ac.

*Major Units:*

1	Antenna unit	8 3/4" x 13 5/8" x 18 3/4"	35 lbs.
1	Cabinet	85" x 17" x 22 1/2"	
1	Multiplier unit	7" x 13 3/4" x 18 3/4"	29.5
1	Oscillator unit	8 3/4" x 10 5/8" x 18 3/4"	35
1	Power control unit	5 1/4" x 7 1/2" x 18 3/4"	15.25
1	Power filter unit	8 3/4" x 11 1/4" x 18 3/4"	62.5
1	Power supply unit	7 1/2" x 13 5/8" x 18 3/4"	62.75
2	Receiver unit	12 1/4" x 13 3/4" x 18 3/4"	46
1	Remote control unit	10 1/2" x 8" x 18 3/4"	24.25

**TUBES, CRYSTALS, TRANSFORMERS:**

**REFERENCE DATA AND LITERATURE:**

TM 11-872.

RADIO RECEIVING SET  
AN/FRR-10, AN/FRR-37

15 Mar 1962

Cog. Serv.: USA FSN: 5820-642-7853 (AN/FRR-10)

5820-644-4782 (AN/FRR-37)

USA USN USAF USMC

## STATUS OR TYPE CLASS.:

Manufacturer: CAN (42498).

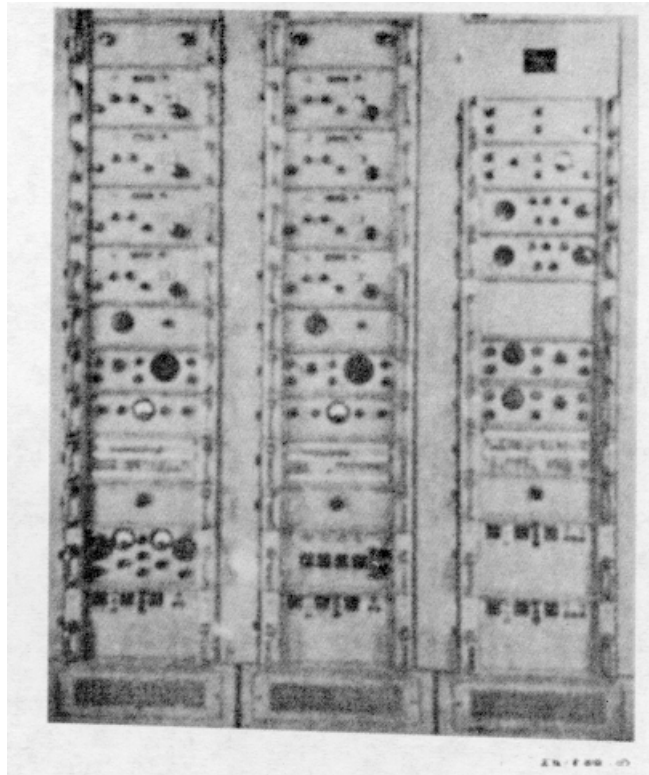

## FUNCTIONAL DESCRIPTION:

These equipments are double conversion, superheterodyne type, diversity receivers for installation at shore stations. Each set consists of two radio receivers together with switching, combining, and filtering circuits.

The AN/FRR-37 consists of two receivers mounted in three bays and is capable of dual diversity operation only.

## RELATIONSHIP TO SIMILAR EQUIPMENT:

The AN/FRR-10 differs from the AN/FRR-37 in that it will receive single sideband signals but will not receive frequency shifted telegraph signals or interrupted cw signals.

## TECHNICAL DESCRIPTION:

*Frequency Range:* 2-32 mc.

*Type of Frequency Control:* Manual tuning with tunable oscillator or crystal controlled oscillator.

*Type Reception:*

AN/FRR-10 A2, A3, A3a, A3b.

AN/FRR-37 A1, A2, A3, F1, F4.

**RADIO RECEIVING SET**  
**AN/FRR-10, AN/FRR-37**

*Type Receiver:* Double heterodyne.

*Intermediate Frequency:* First IF 1750-kc, second IF 50 kc.

*Antenna Input Impedance:* 70 ohms nominal, unbalanced.

*Output Circuit:*

AN/FRR-10 Audio, 60 mw into each of 4 lines, each line to match up to five 600 ohm loads in parallel.

AN/FRR-37 Audio, 60 mw into each of from 1 to 5 resistive loads of 600 ohms in parallel.

Frequency Shift/Facsimile: 50 kc IF at 1 v nominal.

Teletype: 60 ma (110 v and 666 ohms in teletype: loop current is supplied from external loop circuit).

Keyed dc tone: 12 mw into 600 ohms.

*Frequency Stability:*

Temperature: 0.002 percent per degree C frequency variation; 6 db gain variation.

Humidity: 0.025 percent total frequency variation; 6 db gain variation.

*IF Rejection:* Greater than 110 db.

*Sensitivity:*

AN/FRR-10: 2 mv or better.

AN/FRR-37: A2-A3, 2  $\mu$ v or better; A1-F1-F4, 3  $\mu$ v or better.

Gain Variation: Within 6 db over any tuning band.

Reserve Gain: 12 db.

Frequency Overlap: Not less than 1 percent at each end of any frequency band.

Keying Speed (AN/FRR-37): 500 wpm for A1.

Power Source Requirements: 105/115/125 v, 50-60 cps, single phase.

*Major Units:*

AN/FRR-10:

SB-142A/FRR-24	2	5 7/32" x 19" x 15 7/16"	33 lbs.
AM 450B, -451B, -452B and 453B/ FRR-24.	2	6 31/32" x 19" x 16 15/16"	58
CV-126B	2	5 7/32" x 19" x 16 15/16"	33
AM-722/FRR-10	1	6 31/32" x 19" x 16 15/16"	43
AM-851/FRR-10	1	5 7/32" x 19" x 16 15/16"	33
SB-260 and -261/FRR-10	1	5 7/32" x 19" x 15 15/16"	21
AM-900/FRR-10	1	5 7/32" x 19" x 16 15/16"	29
ID-338/FRR-10	1	6 31/32" x 19" x 16 15/16"	32
F-171/FRR-10	2	5 7/32" x 19" x 16 15/16"	38
0-131B/FRR-24	1	6 31/32" x 19" x 16 15/16"	42
0-204/FRR-10	1	6 31/32" x 19" x 16 15/16"	40
SB-253/FRR-10	1	6 31/32" x 19" x 16 15/16"	28
CM-49 and -55/FRR/10	1	5 7/32" x 19" x 16 15/16"	31
PP-844 and -845/FRR/10	2	8 23/32" x 19" x 15 5/16"	96
CY-1377/FRR-10	3	85" x 24" x 22 3/8"	292 lbs.

**RADIO RECEIVING SET  
AN/FRR-10, AN/FRR-37**

*Major Units:*

## AN/FRR-37:

Control Panel SB-142A/FRR-24	2	5 7/32" x 19" x 15 7/16"	33 lbs.
Amplifier-Converter AM-450A, -451A -452A, and -453A/FRR-24	2	6 31/32" x 19" x 16 15/16"	58
CV-126A/FRR-24	2	5 7/32" x 19" x 16 15/16"	33
Amplifier-Detector AM-438A, -439A and -440A/FRR-24.	2	5 7/32" x 19" x 16 15/16"	36
AM-454A/FRR-24	2	5 7/32" x 19" x 16 15/16"	32
SB-281, -282, and -283/FRR-37	1	5 7/32" x 19" x 15 5/16"	21
CV-127A/FRR-24	2	5 7/32" x 19" x 16 15/16"	35
F-207/FRR-37	2	5 7/32" x 19" x 16 15/16"	45
O-131A/FRR-24	1	6 31/32" x 19" x 16 15/16"	42
SB-280/FRR-37	1	6 31/32" x 19" x 16 15/16"	28
CM-32A/FRR-24	1	5 7/32" x 19" x 16 15/16"	33
KY-62A/FRR-24	2	5 7/32" x 19" x 16 15/16"	39
PP-912 and -913/FRR-37	1	8 23/32" x 19" x 15 5/16"	96
CY-1377/FRR-10	3	85" x 24" x 22 3/8"	292 lbs.

**TUBES, CRYSTALS, TRANSISTORS:****REFERENCE DATA AND LITERATURE:**

NAVSHIPS 92144.  
NAVSHIPS 91896.



RADIO RECEIVING SET  
AN/FRR-12

1 March 1964

Cog. Serv.: USA FSN: 5820-164-7219

USA Line Item No: 636215

	USA	USN	USAF	USMC
STATUS OR TYPE CLASS.:	Obs	L/Std		

Manufacturer:

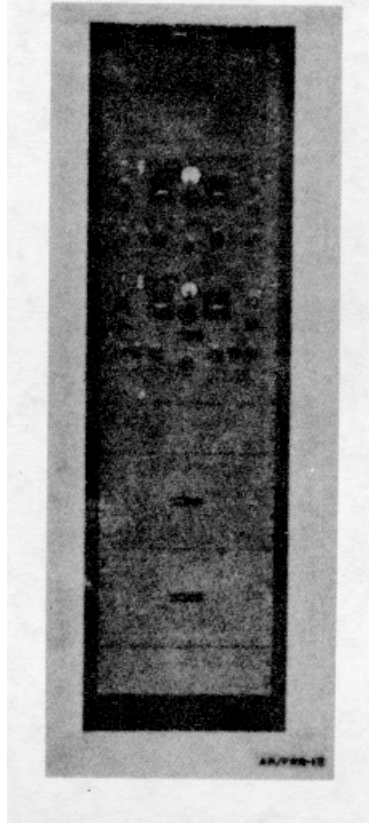
**FUNCTIONAL DESCRIPTION:**

Radio Receiving Set AN/FRR-12 is a fixed-station, dual-diversity receiving set for use in point-to-point radio teletype systems. This set may also be used for cw, mcw, or am voice reception.

This equipment consists primarily of two Radio Receivers R-270/FRR (modified) mounted, with their power supplies, in a standard steel floor-type cabinet. Sufficient space is available in the equipment rack to install separately procured radioteletype converts such as Converter CV-31/TRA-7.

The receivers have noise-limiter, bandsread, phasing, volume, and beat frequency-oscillator controls. the received frequency can be either crystal-controlled or manually selected.

**RELATIONSHIP TO SIMILAR EQUIPMENT:****TECHNICAL DESCRIPTION:**

*Frequency range in mc:* 1.25 to 40 in 5 bands.

*Type Modulation:* am.

*Type of Signal:* cw, mcw, voice, fsk radio teletype.

**RADIO RECEIVING SET  
AN/FRR-12**

*Power Requirements:* 400 w, 95-130/190-260 v 25-60 cycle ac.

*Major Units:*

2 RA-74-D	10 1/2" x 10 1/4" x 19"	60.5 lbs.
2 R-27/FRR	10 1/2" x 16 3/4" x 19"	60.50 lbs

**TUBES, CRYSTALS, TRANSISTORS:**

**REFERENCE DATA AND LITERATURE:**

TM 11-896.  
(USA) 69-19; 3280.

RADIO RECEIVING SET  
AN/FRR-12X

1 March 1964

Cog. Serv.: USA FSN: 5820-187-3141

USA Line Item No: 636216

	USA	USN	USAF	USMC
STATUS OR TYPE CLASS.:	StdC		L/Std	

Manufacturer: The Hallicrafter Co.

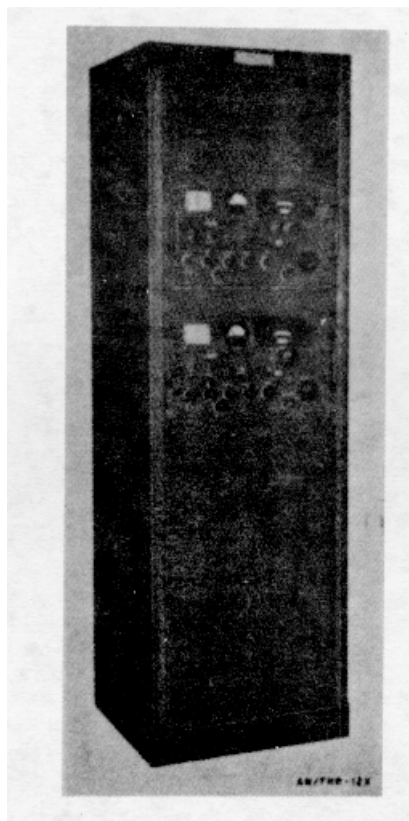
**FUNCTIONAL DESCRIPTION:**

Radio Receiving Set AN/FRR-12X provides the same services in the same applications as Radio Receiving Set AN/FRR-12. The AN/FRR-12X uses later model receivers that have self-contained power supplies.

This equipment consists of two Radio Receivers R-274/FRR and a terminal box installed in a standard steel floor-type cabinet. Space is available for installation of additional equipment in the rack.

The receivers have rf and audio gain, phasing, and beat-frequency-oscillator controls. The receivers can be either crystal or manually controlled.

**RELATIONSHIP TO SIMILAR EQUIPMENT:****TECHNICAL DESCRIPTION:**

*Frequency Range in mc:* 0.54 to 54.0.

*Type Modulation:* am.

*Type of Signal:* cw, tone, voice, fsk.

**RADIO RECEIVING SET  
AN/FRR-12X**

*Power Requirements:* 240 w, 95/105/117/130/190/210/234/360 v 50-60-cycle ac.

*Major Units:*

2	R-274/FRR	10 1/2" x 16 3/4" x 29"	58 lbs.
1	J-346/FRR-12X	7 3/4" x 3" x 4 1/4"	2.2 lbs.

**TUBES, CRYSTALS, TRANSISTORS:**

**REFERENCE DATA AND LITERATURE:**

TM 11-896A.

RADIO RECEIVING SET  
AN/FRR-26

15 March 1962

Cog. Serv.: USA FSN: 5820-665-1229

USA Line Item No:

USA    USN    USAF    USMC

**STATUS OR TYPE CLASS.:**

Manufacturer: CCI.

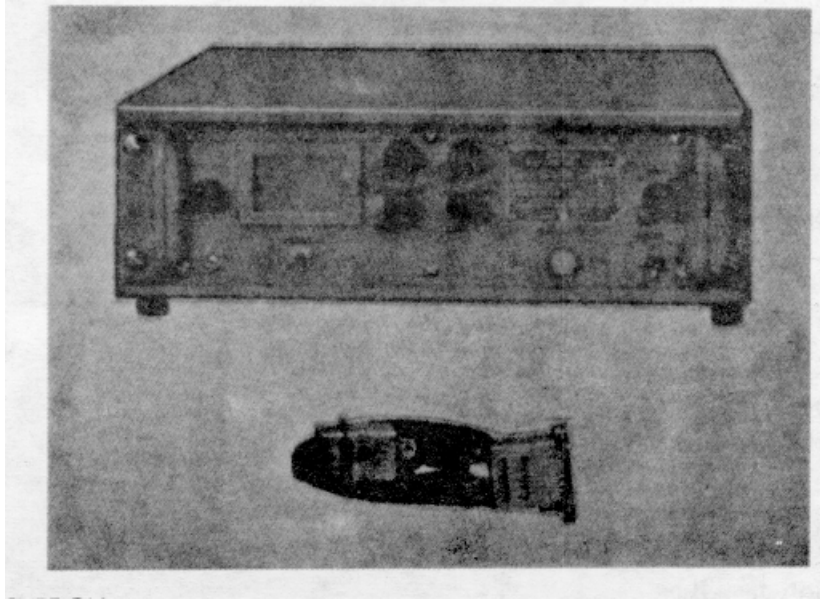
**FUNCTIONAL DESCRIPTION:**

Radio Receiving Set AN/FRR-26 is a fixed-tuned, vhf double conversion superheterodyne receiver for single channel, crystal controlled operation. The set is used in air traffic control towers at naval air stations, at naval shore stations or advanced bases in point-to-point communication circuits. The receiver provides for both local and limited remote operations and is capable of continuous operation over long periods.

**RELATIONSHIP TO SIMILAR EQUIPMENT:**

The AN/FRR 26 is part of a series of fixed tuned, crystal controlled radio receivers similar in design and construction, but with different frequency ranges:

AN/FRR-26 2-8 mc  
 AN/FRR-27 100-156 mc.  
 AN/FRR-30 200-560 mc  
 AN/FRR-32 8-32 mc.

**TECHNICAL DESCRIPTION:***Frequency Range:*

Band 1: 2-4 mc  
 Band 2: 4-6 mc.  
 Band 3: 6-8 mc.

*Number of Preset Frequencies:* One, as determined by Crystal CR-18/U.

*Type of Frequency Control:* Crystal-controlled oscillators.

## RADIO RECEIVING SET AN/FRR-26

*Type Receiver:* Double conversion superheterodyne.

*Intermediate Frequencies:* 455 kc first IF, 120 kc second IF.

*Receiver Output:*

Audio Channel: At least 1.5 w into a 200-600-ohm load with less than 7 percent distortion.

Phone Jack: At least 15 mw into a 600-ohm load with less than 7 percent distortion.

*Type Reception:* A1, A2, and A3.

*Frequency Stability Variation:*

Line Voltage:  $\pm 10$  percent variation of input voltage does not vary resonant frequency by more than 100 cy.

Power Line Frequency: 50-60 cps.

Ambient Temperature: 15°C. to +50°C. does not vary resonant frequency by more than 200 cy.

*Squelch Circuit:*

Effective Silencing Range: 1 to over 100  $\mu$ v.

Time Constant: Under 0.2 sec.

*Impedance:*

Antenna Input: 72 ohms, unbalanced.

Audio Channel Outputs:

Audio Receptacles: Load can be within a range of 200-600 ohms with 2 db max variation of audio output.

*Headphone Jack:* Used with 600-ohm headphone.

*Operating Power Requirements:* 105/115/125v  $\pm 10$  percent, 50-60 cps; 0.157 amp at 115 v; 62 w at 115 v rms.

*Major Unit:* 1 R-517/FRR-26 6" x 17" x 18 3/4" 40 lbs.

## TUBES, CRYSTALS, TRANSISTORS

## REFERENCE DATA AND LITERATURE:

NAVSHIPS 92557.

RADIO RECEIVING SET  
AN/FRR-27

15 March 1962

Cog. Serv.: USA FSN: 5820-665-3515

USA Line Item No:

USA USN USAF USMC

STATUS OR TYPE CLASS.:

Manufacturer: CCI.

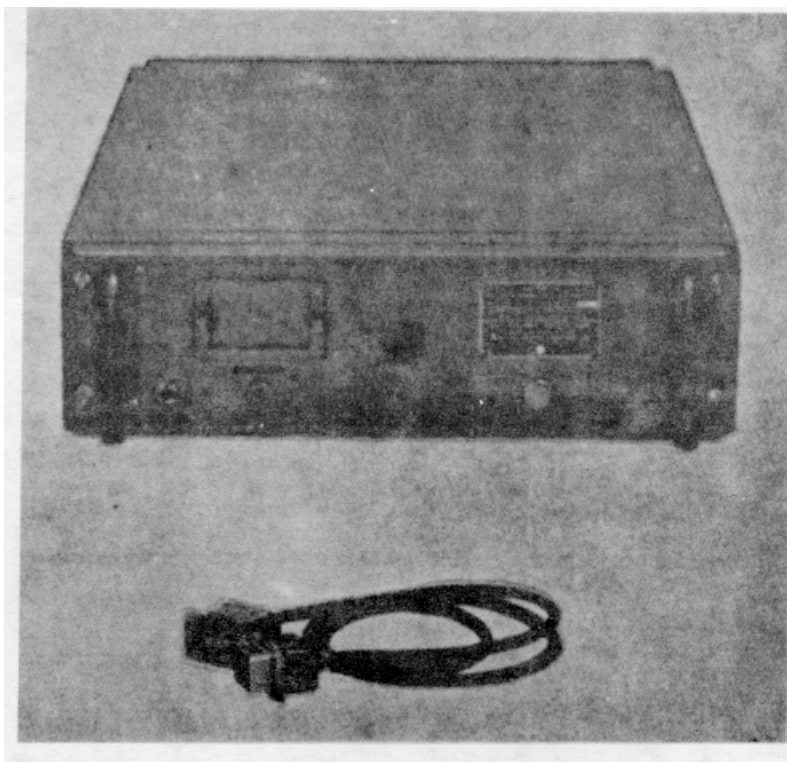
**FUNCTIONAL DESCRIPTION:**

Radio Receiving Set AN/FRR-27 is a fixed-tuned vhf double conversion superheterodyne receiver for single channel crystal controlled operation. The set is used in air traffic control towers at naval air stations, and can be used at naval shore stations or advanced bases in point-to-point communication circuits.

**RELATIONSHIP TO SIMILAR EQUIPMENT:**

The set is part of a series of fixed-tuned, crystal controlled radio receivers, similar in design and construction but with different frequency ranges:

- AN/FRR-26 2-8 mc.
- AN/FRR-27 100-156 mc.
- AN/FRR-30 200-560 kc.
- AN/FRR-31 8-32 mc.

**RADIO RECEIVING SET  
AN/FRR-27**

**TECHNICAL DESCRIPTION:**

*Frequency Range:* 100-156 mc in 1 band.

*Reception:* A2 and A3 (amplitude modulated voice and tone).

*Frequency Control:* Crystal controlled oscillator.

*Intermediate Frequencies:* 23 mc and 3 mc.

*Power Output:*

Audio Channel: 1.5 w min into 200-600-ohm load with less than 7 percent distortion.

Phone Jack: 15 mw min into 600-ohm load.

*Frequency Stability (receiver):*

Line Voltage: Variation in line voltage of  $\pm 10$  percent of normal does not vary resonant freq by more than 0.002 percent.

Ambient Temperature: Variation in ambient temp between 20°C. to +50°C. does not vary resonant freq by more than 0.01 percent from 25°C.

*Squelch Circuit:*

Effective Silencing Range: 1-100  $\mu$ v.

Time Constant: 0.2 sec max.

Audio Output Reduction: Over 40 db.

*Operating Power Requirements:* 105/115/125 v, 50-60 cps, single phase, 0.50 amp, 54 w nominal.

*Antenna Input:* 50 ohms, unbalanced.

*Major Units:*                   1           R-518/FRR-27                   6" x 17" x 18 3/4"                   38.5 lbs.

**TUBES, CRYSTALS, TRANSISTORS:**

**REFERENCE DATA AND LITERATURE:**

NAVSHIPS 92021, Technical Manual for Radio Receiving Set AN/FRR-27.



RADIO RECEIVER SET  
AN/FRR-33

1 July 1958

Cog. Serv.: USA FSN: 5815-503-1501

USA Line Item No: 658486

	USA	USN	USAF	USMC
STATUS OR TYPE CLASS.:	Std A		L/Std	

Manufacturer: Collins Radio Co.

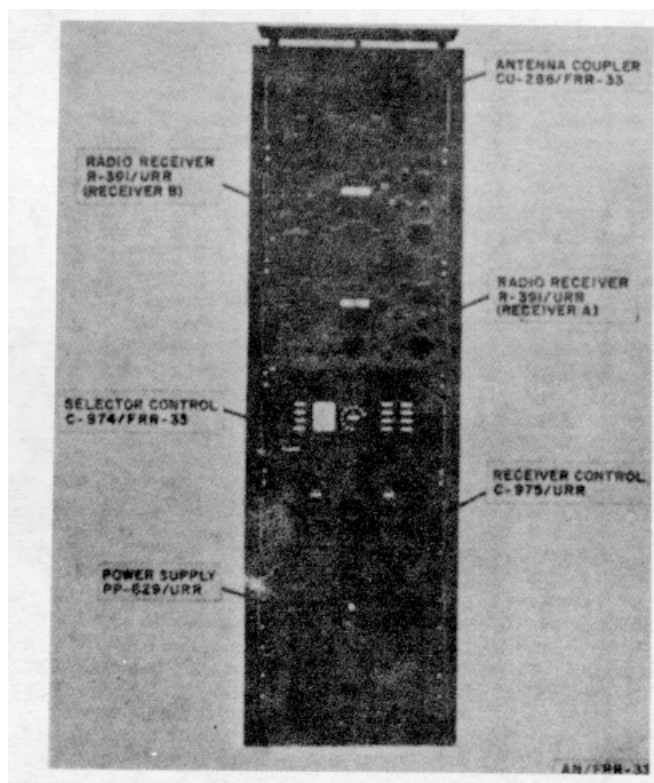
**FUNCTIONAL DESCRIPTION:**

Radio Receiving Set AN/FRR-33 is a dual-diversity equipment used for minimizing the effects of fading in radioteletype signals. It is operated in conjunction with Radioteletype Terminal Equipment AN/F-G1 in fixed plant military communication applications at higher headquarters.

This equipment includes two identical radio receivers, an antenna coupler, a selector control, a receiver control, a remote switching control, and a power supply, all of which are rack-mounted in a steel cabinet. A complete diversity antenna system, providing two rhombic antennas for each set, is required but not supplied with this equipment.

As many as three AN/FRR-33 systems can be controlled by the remote switching control.

**RELATIONSHIP TO SIMILAR EQUIPMENT:****TECHNICAL DESCRIPTION:**

*Frequency Range in mc:* 0.5 to 32.

*Type Modulation:* am.

RADIO RECEIVING SET  
AN/FRR-33

*Type of Signal:* cw, voice, fsk radio tty (850-cy shift).

*Power Requirements:* 1,475 w, 115/230 v 48-62 cy ac.

*Major Units:*

1	CY-119/U	20 13/16" x 21 27/32" x 76"
1	PP-629/URR	19" x 15 15/64" x 10 1/2"
2	R-391/URR	19" x 14 1/2" x 10 1/2"
1	C-975/URR	19" x 17 9/16" x 8 3/4"
1	C-973/FRR-33	9 21/64" x 12 51/64" x 8 7/32"
1	C-974/FRR-33	19" x 15 5/16" x 8 3/4".

**TUBES, CRYSTALS, TRANSISTORS.**

**REFERENCE DATA AND LITERATURE.**

TM 11-871.

MIL-D-10251.

RADIO RECEIVING SET  
AN/FRR-34

1 March 1964

Cog. Serv.: USA FSN: 5820-503-1496

USA Line Item No: 658487

	USA	USN	USAF	USMC
STATUS OR TYPE CLASS.:	Std A			

Manufacturer: Collins Radio Co.

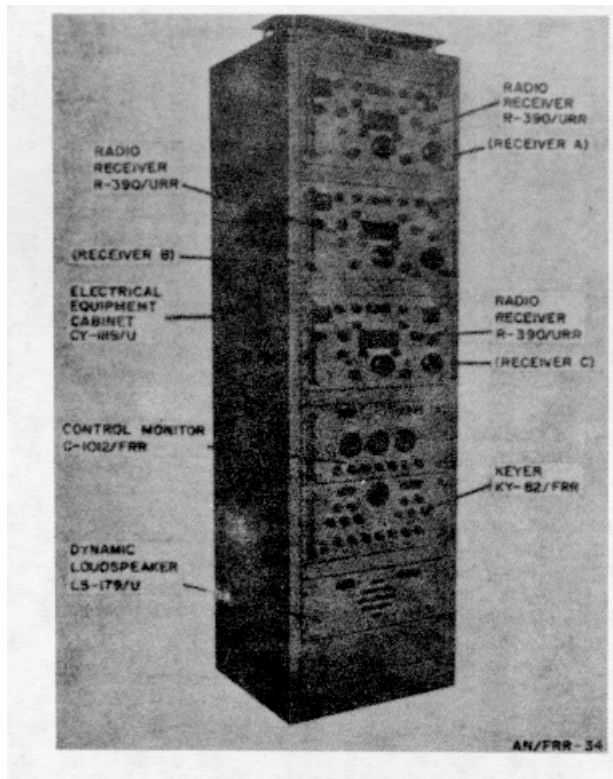
**FUNCTIONAL DESCRIPTION:**

Radio Receiving Set AN/FRR-34 is a triple-diversity equipment used for the reception of radio-telephone, radiotelegraph, and radioteletype signals.

This equipment consists essentially of three receivers, a control monitor, a keyer, and a loudspeaker, all mounted in an equipment cabinet.

By means of switching circuits in the keyer, the following modes of operation can be selected: each receiver separately; two in dual diversity or three in triple diversity, to minimize fading; or two in dual diversity while the third is operated as a search receiver on other frequencies.

**RELATIONSHIP TO SIMILAR EQUIPMENT:****TECHNICAL DESCRIPTION:**

*Frequency Range in mc:* 0.5 to 32.

*Type Modulation:* am.

*Type of Signal:* cw, mcw, voice.

**RADIO RECEIVING SET****AN/FRR-34**

*Power Output:* 5 mw (phones); 10 mw (600-ohm balanced line); 500 mw (600-ohm unbalanced line).

*Power Requirements:* 980 w, 115/230 v 50/60-cy 1-phase ac.

*Major Units:*

1	C-1012/FRR	19" x 8 23/32" X 13 5/16"
1	LS-179/U	19" X 2 7/8" X 6 31/32"
1	CY-1119/FRR	21 7/8" X 20 13/16" X 76"
1	KY-82/FRR	19" X 18 11/16" X 8 23/32"
3	R-390/URR	19" X 14 1/2" X 10 1/2"

**TUBES, CRYSTALS, TRANSISTORS:****REFERENCE DATA AND LITERATURE:**

TM 11-864.

MIL-R-19090A.

RADIO RECEIVING SET  
AN/FRR-36

1 March 1964

Cog. Serv.: USA FSN: 5820-503-1503

USA Line Item No: 658488

	USA	USN	USAF	USMC
STATUS OR TYPE CLASS.:	Std A			

Manufacturer: Motorola, Inc.

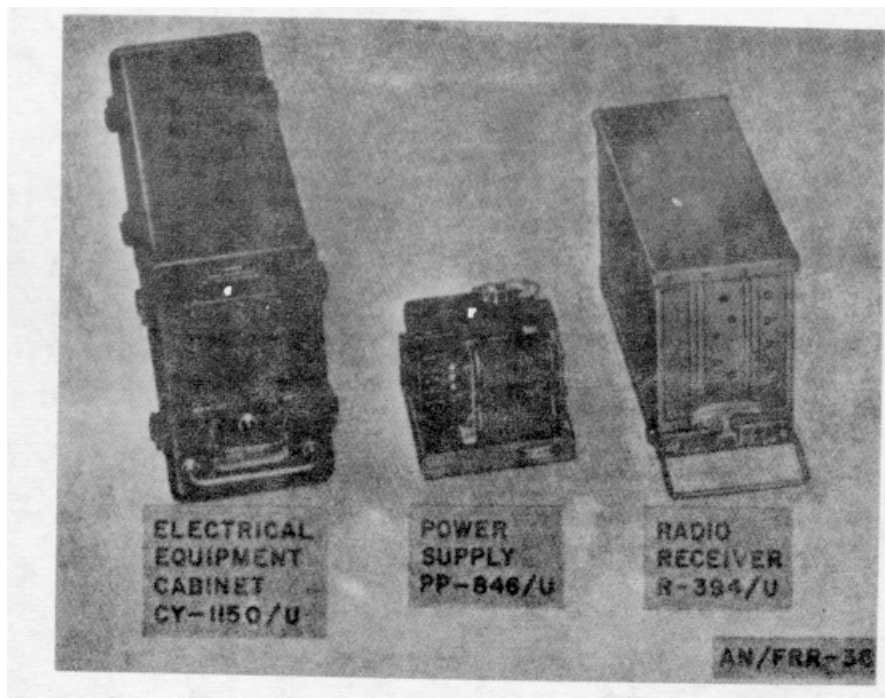
**FUNCTIONAL DESCRIPTION:**

Radio Receiving Set AN/FRR-36 is a vhf fm (voice) equipment used in monitoring and communication applications.

This set consists essentially of a radio receiver with its power supply, housed in a metal equipment cabinet, and includes an appropriate vertical antenna.

It is a fixed-station equipment; the same receiver component with different power-supply and antenna component, for vehicular installation, is Radio Receiving Set AN/VRR-7.

**RELATIONSHIP TO SIMILAR EQUIPMENT:****TECHNICAL DESCRIPTION:**

*Frequency Range in mc:* 152 to 174.

*Type Modulation:* fm.

*Type of Signal:* Voice.

*Power Requirements:* 46 va, 115/230 v 50/60 cy ac.

**RADIO RECEIVING SET  
AN/FRR-36***Major Units:*

1	AT438/GR	21" x 57 1/4" x 57 1/4"	7.5 lbs
1	CY-1150/U	10 5/8" x 21 1/4" x 7 1/2"	14.5 lbs.
1	PP-846/U	5" x 6 1/4" x 7 1/16"	9.5 lbs.
1	R-394/U	8 1/2" x 14 1/2" x 5 3/4"	17 lbs.

**TUBES, CRYSTALS, TRANSISTORS:****REFERENCE DATA AND LITERATURE:**

TM 11-229.  
MIL-N-11539.

RADIO RECEIVING SET  
AN/FRR-38( )

1 March 1964

Cog. Serv.: USA FSN: 5820-503-1497

USA Line Item No: 658490

	USA	USN	USAF	USMC
STATUS OR TYPE CLASS.:	Std A		L/Std	

Manufacturer: Hoffman, Labs, Inc.

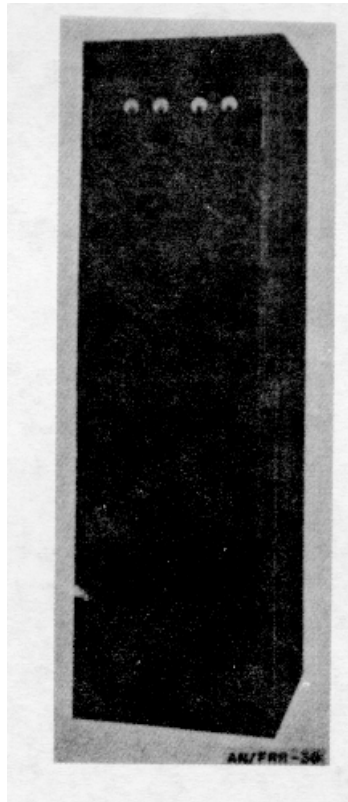
**FUNCTIONAL DESCRIPTION:**

Radio Receiving Set AN/FRR-38( ) is a dual-diversity equipment that receives frequency-shift-keyed, single-channel, or time-division multiplex radioteletype signals. It is used as a radio receiver in a space-diversity radioteletype communications system.

This equipment consists of two receivers and a frequency-shift converter mounted in an equipment cabinet and includes an installation kit.

**TUBES, CRYSTALS, TRANSISTORS:****REFERENCE DATA AND LITERATURE:**

*Frequency Range in mc:* 0.5 to 32.  
*Type Modulation:* am.  
*Type of Signal:* cw, mcw, voice, fsk.

**RADIO RECEIVING SET  
AN/FRR-38( )**

*Power Requirement:* 270 w, 115/230 v 50/60 cy 1-phase ac.

*Major Units:*

1	CY-1119/U	76" x 20 1/2" x 21 27/32"	225 lbs.
1	CV-116/URR	8 3/4" x 17" x 19"	65 lbs.
2	R-390/URR	10 1/2" x 17 1/4" x 19"	80 lbs.

**TUBES, CRYSTALS, TRANSISTORS:****REFERENCE DATA AND LITERATURE:**

TM-11-674.



RADIO RECEIVING SET  
AN/FRR-39

1 March 1964

Cog. Serv.: USA FSN: 5820-503-1515

USA Line Item No: 658491

	USA	USN	USAF	USMC
STATUS OR TYPE CLASS.:	Std A			

Manufacturer: Collins Radio Co.

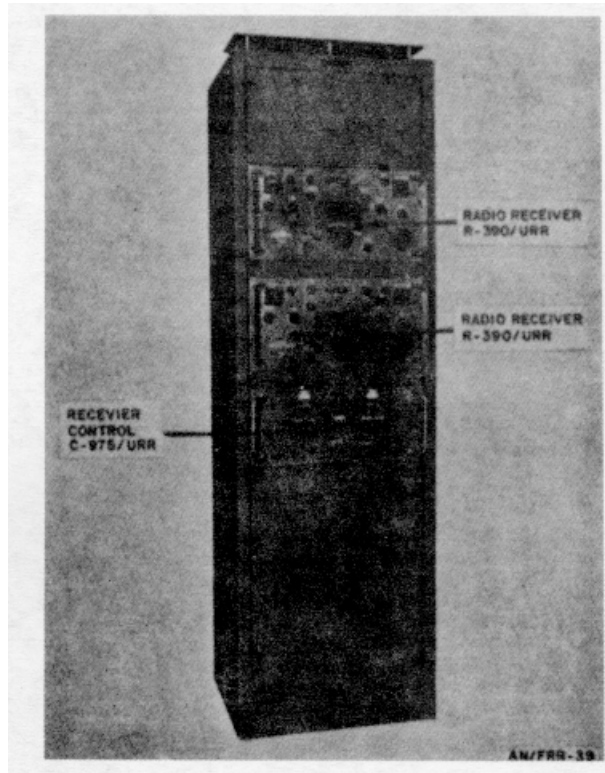
**FUNCTIONAL DESCRIPTION:**

Radio Receiving Set AN/FRR-39 is a diversity equipment used at a terminal of a system to receive frequency-shift-keyed, single-channel or time-division multiplex, teletypewriter signals; it also can be used to receive voice, cw, or tone signals.

It consists of two receivers and a receiver control unit mounted in an equipment cabinet.

This equipment is operated in conjunction with Radioteletype Terminal Equipment AN/FGC-11( ), or other similar radioteletype converter equipment.

**TUBES, CRYSTALS, TRANSISTORS:****REFERENCE DATA AND LITERATURE:**

*Frequency Range in mc:* 0.5 to 32.

*Type Mode:* am (ssb or dsb).

*Type of Signal:* ce, mcw, voice, fsk.

*Power Output:* 5 mw (phones); 10 mw (60-ohm bal line); 500 mw (600-ohm unbal line).

**RADIO RECEIVING SET  
AN/FRR-39**

*Power Requirements:* 270 w, 115/230 v 50/60-cy 1-phase ac.

*Major Unit:*

1	CY-1119/U	78 1/2" x 20 13/16" x 21 7/8"	165 lbs.
2	R390/URR	10 1/2" x 17 1/4" x 19"	80 lbs.
1	C-76/URR	8 3/4" x 16 1/2" x 19"	48 lbs.

**TUBES, CRYSTALS, TRANSISTORS:****REFERENCE DATA AND LITERATURE:**

TM 11-648.

**RADIO RECEIVING SET  
AN/FRR-40, -41**

1 March 1964

**Cog. Serv.:** USA FSN: 5820-545-7325 (AN/FRR-40); 5820-503-1513 (AN/FRR-41).

**USA Line Item No:** 658492 (-40); 658493 (-41).

	USA	USN	USAF	USMC
<b>STATUS OR TYPE CLASS.:</b>	Std A		Std	

**Manufacturer:** Hoffman Labs, Inc.

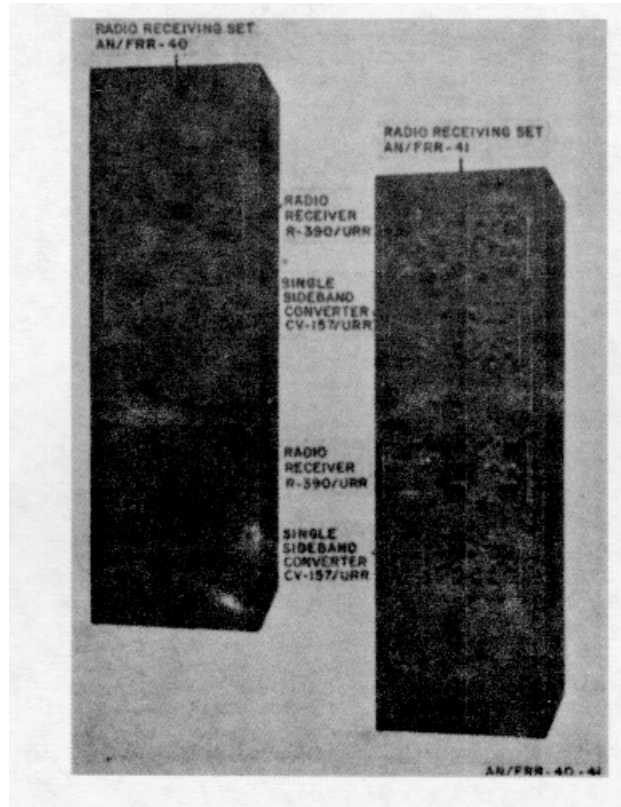

**FUNCTIONAL DESCRIPTION:**

Radio Receiving Sets AN/FRR-40 and AN/FRR-41 are used for the reception of single-sideband or twin single-sideband radio signals that carry multiplex teletypewriter, facsimile, and/or voice intelligence.

The AN/FRR-40 consists of one receiver and a single-sideband converter housed in a metal equipment cabinet. The AN/FRR-41, composed of two receivers and two converters housed in a metal equipment cabinet, is used for dual-diversity reception.

Both equipments are used in long-range applications between installations that have a heavy flow of message traffic. The audio output of each of these sets is capable of operating voice-reproducing equipment directly, or of feeding carrier terminal equipment that provides several teletypewriter or facsimile channels.

**RELATIONSHIP TO SIMILAR EQUIPMENT:**

**RADIO RECEIVING SET  
AN/FRR-40, -41**

**TECHNICAL DESCRIPTION:**

*Frequency Range in mc:* 0.5 to 32.

*Type Modulation:* am (rob or dsb).

*Type of Signal:* voice, cw, tone (radioteletype).

*Power Requirements:* 520 w (AN/FRR-40), 1, 040 w (AN/FRR-41), 105-125-210/250 v 50/60-cy 1 phase ac.

*Major Units:*

1	CY-1119/U	76" x 20 1/2" x 21 27/32"	225 lbs.
1	R-390/URR	10 1/2" x 17 1/4" x 19"	80 lbs.
1	CV-157/URR	15 3/4" x 15" x 19"	104 lbs.

**TUBES, CRYSTALS, TRANSISTORS:**

**REFERENCE DATA AND LITERATURE:**

TM 11-49.

RADIO RECEIVING SET  
AN/FRR-44

1 March 1964

Cog. Serv.: USA FSN: 5820-503-1504

USA Line Item No: 658496

	USA	USN	USAF	USMC
STATUS OR TYPE CLASS.:	Std A			

Manufacturer: Motorola, Inc.

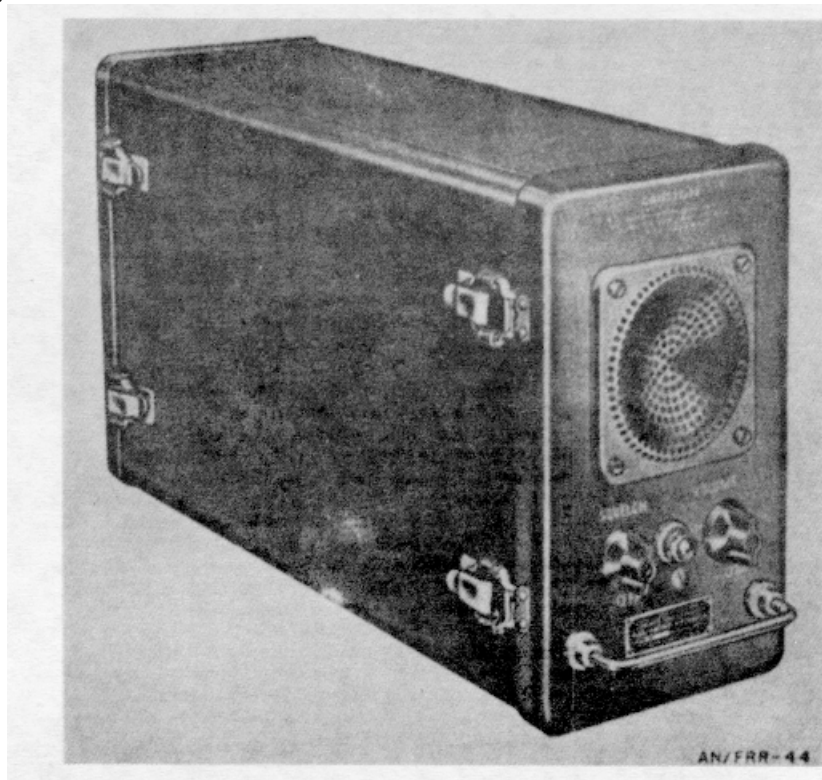
**FUNCTIONAL DESCRIPTION:**

Radio Receiving Set AN/FRR44 is a vhf (FM-voice) fixed station equipment used primarily for monitoring and radio communication applications.

This equipment consists essentially of a radio receiver and its power supply, housed in an equipment cabinet, and includes antenna and accessory components.

The primary operating component, Radio Receiver R-257/U, is also used as the receiving component of such radio equipments as Radio Sets AN/FRC-15, AN/TRC-22, and AN/VRC-6( ).

**RELATIONSHIP TO SIMILAR EQUIPMENT:****TECHNICAL DESCRIPTION:**

*Frequency Range in mc:* 25 to 50.

*Type Modulation:* fm.

*Type of Signal:* voice, tone.

**RADIO RECEIVING SET  
AN/FRR-44**

*Power Requirement:* 0.4 amp, 115 v 50/60 cy ac; or 0.2 amp, 230 v 50/60-y ac.

*Major Units:*

1	AS612/U	11 1/2" x 5 1/4" x 41"	30.0 lbs.
1	CY-1150/U	10 5/8" x 21 1/4" x 7 1/2"	14.5 lbs.
1	PP-s4/U	5" x 6 1/4" x 7 1/16"	9.5 lbs.
1	R-257/U	8 1/2" x 14 1/2" x 53/4"	17.0 lbs.

**TUBES, CRYSTALS, TRANSISTORS:****REFERENCE DATA AND LITERATURE:**

TM 11-225.  
MIL-N-11539.

**RADIO RECEIVING SET**  
**AN/FRR-59**  
**AN/WRR-2**

15 March 1962  
 Cog. Serv.: USA FSN: 5820-775-9082  
 USA Line Item No:

	USA	USN	USAF	USMC
<b>STATUS OR TYPE CLASS.:</b>	AN/WRR-2	Std		
	Obs			

**Manufacturer:** CAN (42498)

**No Illustration Available**

**FUNCTIONAL DESCRIPTION:**

The AN/WRR-2 and AN/FRR-59 are general-purpose receiving sets capable of receiving either dsb .or 8ab transmission. The dsb is continuously tuned, the mb is tuned in 1 kc increments. The set is used for voice, cw, teletype, and facsimile. The AN/WRR-2 is mounted in a special shock mount and has retractable tilting slides for easy accessibility.

**RELATIONSHIP TO SIMILAR EQUIPMENT:**

The AN/WRR-2 is identical to AN/FRR-59, with the exception of the shock mount.

**TECHNICAL DESCRIPTION:**

*Frequency Range:* 2 to 32 mc, 4 bands.  
*Reception:* A1, A2, A3, A4, A9, F1.  
*Frequency Stability:* 1 part in 107.  
*Operating Power Requirements:* 105/115/125/VAC, 50 to 60 cps, single phase, 250 w.

*Major Units:*

1	CV-920fWRR-2	12.2" x 19.8" x 22.5"	135 lbs.
1	AM-2477/WRR-2	10.5" x 19.8" x 22.5"	100 lbs.
1	MT-2293/WRR-2 (used with the AN/WRR-2 only)	25.8" x 22" x 24"	50 lbs.
2	Cabinet Braces	22" x 17"	15 lbs.

**TUBES, CRYSTALS, TRANSISTORS:**

**REFERENCE DATA AND LITERATURE:**

NAVSHIPS 93440.  
 NAVSHIPS 93550.42.

**ELECTRONIC FREQUENCY CONVERTER**  
**AN/FRR-type**  
**CV-861A/FRR**

15 March 1962

Cog. Serv.: USA FSN:

USA Line Item No:

USA	USN	USAF	USMC
-----	-----	------	------

---

**STATUS OR TYPE CLASS.:**

---

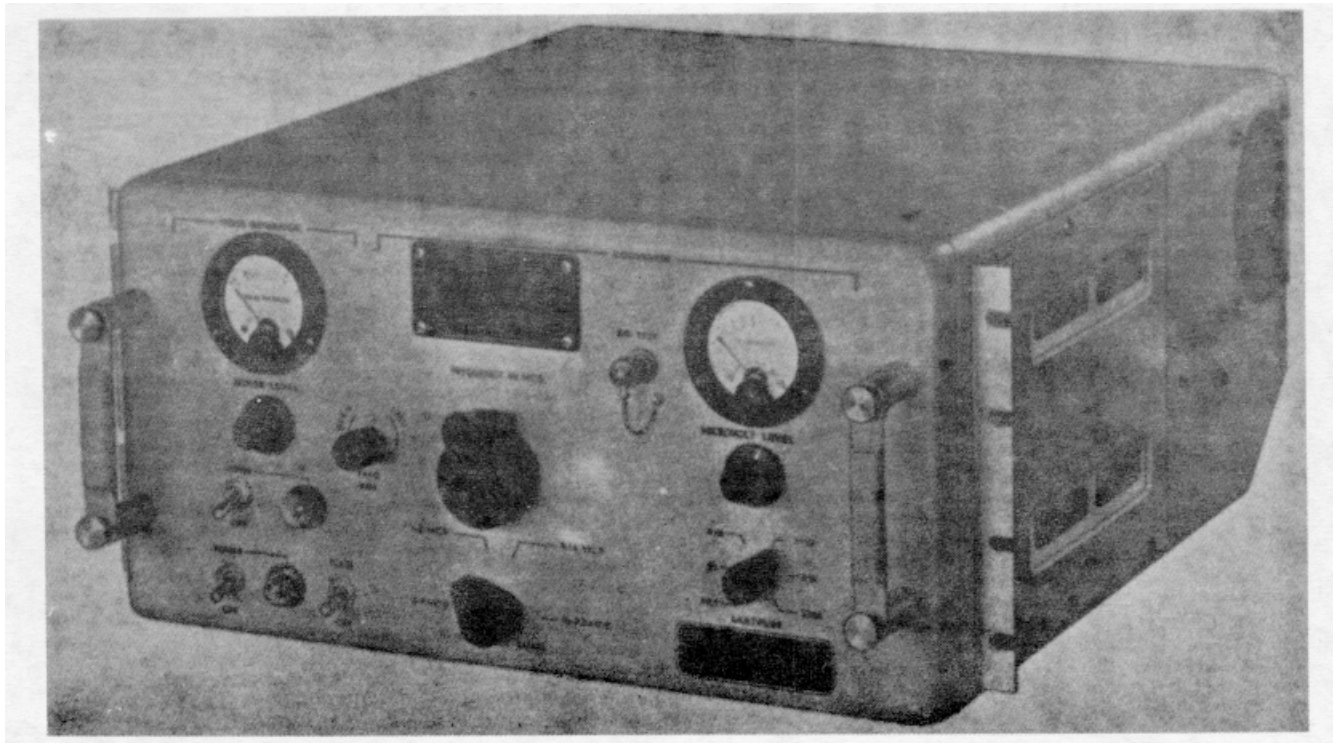
**Manufacturer:****FUNCTIONAL DESCRIPTION:**

Electronic Frequency Converter CV-861A/FRR mixes an internally generated signal with two external frequencies to produce a variable amplitude output in the frequency range of 2 to 32 megacycles. It consists of seven circuits: a crystal-controlled oscillator, a mixer-IF amplifier, a balanced modulator, an RF amplifier-cathode follower, an attenuator, a noise generator, and a power supply.

**RELATIONSHIP TO SIMILAR EQUIPMENT:**

None.

**TECHNICAL DESCRIPTION:**

*Input Frequency:* 125 kc cw or icw: 3.675 to 33.675 mc, cw.

*Output Frequency:* 2 to 32 mc, fm, cw, icw: in four bands.

*Output Amplitude:* 0.1 lv to 0.1 v.

*Noise Generator output:* Random noise with response of  $\pm 1$  db over the range of the equipment:  
 2 to 32 min



**ELECTRONIC FREQUENCY CONVERTER**

**AN/FRR-type  
CV-861A/FRR**

*Output Impedance:* 70 ohms  $\pm$  3.5.

*Crystal Oscillator:* CR-27/U, 1800 kc.

*Operating Power Requirements:* 105/115/125 v, 60 cps, 10, 1.3 amps, 115 w.

*Major Unit:* CV-861A/FRR 8 5/8" x 19" x 23 3/16"

**TUBES, CRYSTALS, TRANSISTORS:**

**REFERENCE DATA AND LITERATURE:**

NAVSHIPS 94291.

**RADIO RECEIVER  
AN/FRR-type  
R-274/FRR**

1 March 1964

Cog. Serv.: USA FSN: 5820-187-3143

USA Line Item No: 635870

	USA	USN	USAF	USMC
STATUS OR TYPE CLASS.:	StdC	Std		

Manufacturer:

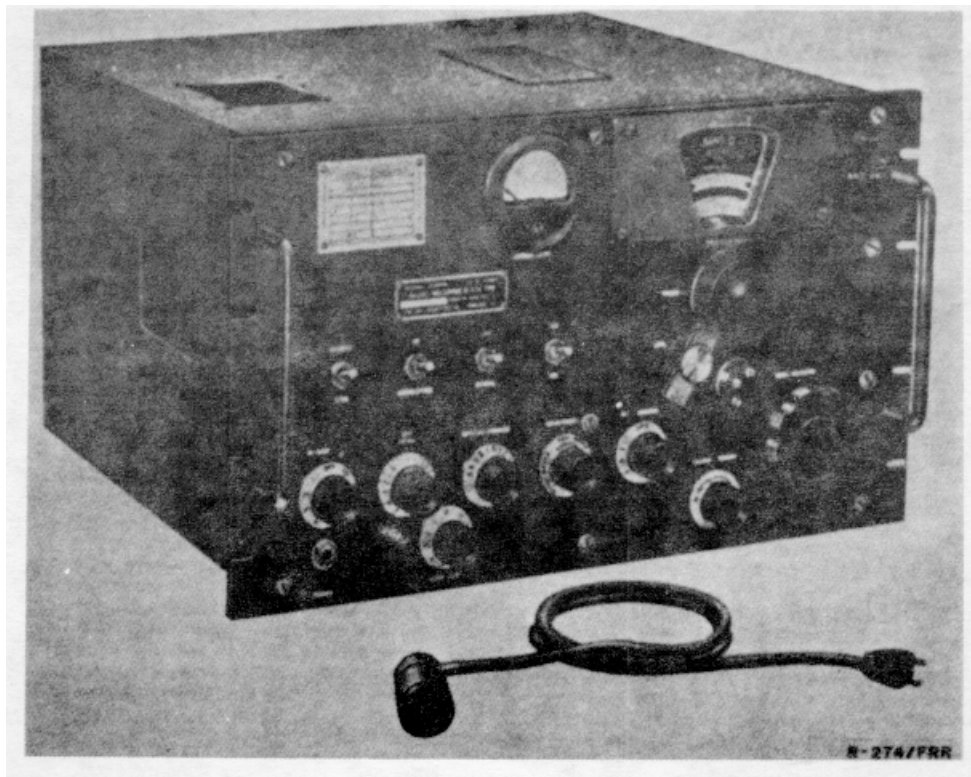

**FUNCTIONAL DESCRIPTION:**

Radio Receiver R-274/FRR is a medium-, high-, and very-high-frequency am (voice, tone and cw) receiving equipment used for communication and special applications in fixed plant and similar installations.

This equipment consists of a single radio receiver component having a built-in power supply that is mounted on a panel for rack mounting. It requires additional equipment for reproduction of audio signals.

Carrier shift signals can be fed to appropriate teletypewriter terminal equipment or to Dual Diversity Converter CV-31/TRA-7 and similar units. Provision is made for use of the audio end of this radio receiver alone, and for standby operation when used in conjunction with radio transmitting equipment.

It operates with a single-wire antenna or any of the more complex fixed radio station antennas.

**RELATIONSHIP TO SIMILAR EQUIPMENT:**

**RADIO RECEIVER**  
**AN/FRR-type**  
**R-274/FRR**

**TECHNICAL DESCRIPTION:**

*Frequency Range in mc:* 0.54 to 54.

*Type Modulation:* am.

*Type of Signal:* cw, tone, voice, frequency shift keyed radioteletype (with additional equipment).

*Power Requirements:* 120 w, 95/260 v (in 8 different steps) 50-60-cy ac.

*Major Unit:*

1	R-274/FRR	10 15/32" x 18 1/8" x 19"	58 lbs.
---	-----------	---------------------------	---------

**TUBES, CRYSTALS, TRANSISTORS:**

**REFERENCE DATA AND LITERATURE:**

TM 11-897.  
(USA) 71-3340.

**RADIO RECEIVER**  
**AN/FRR-type**  
**R-274A/FRR**  
**R-274C/FRR**

1 March 1964

Cog. Serv.: USA FSN: 5820-187-3143

USA Line Item No: 635871 (-C)

	USA	USN	USAF	USMC
STATUS OR TYPE CLASS.:	Std C	(-A) L/Std	(-C) Std	

Manufacturer:

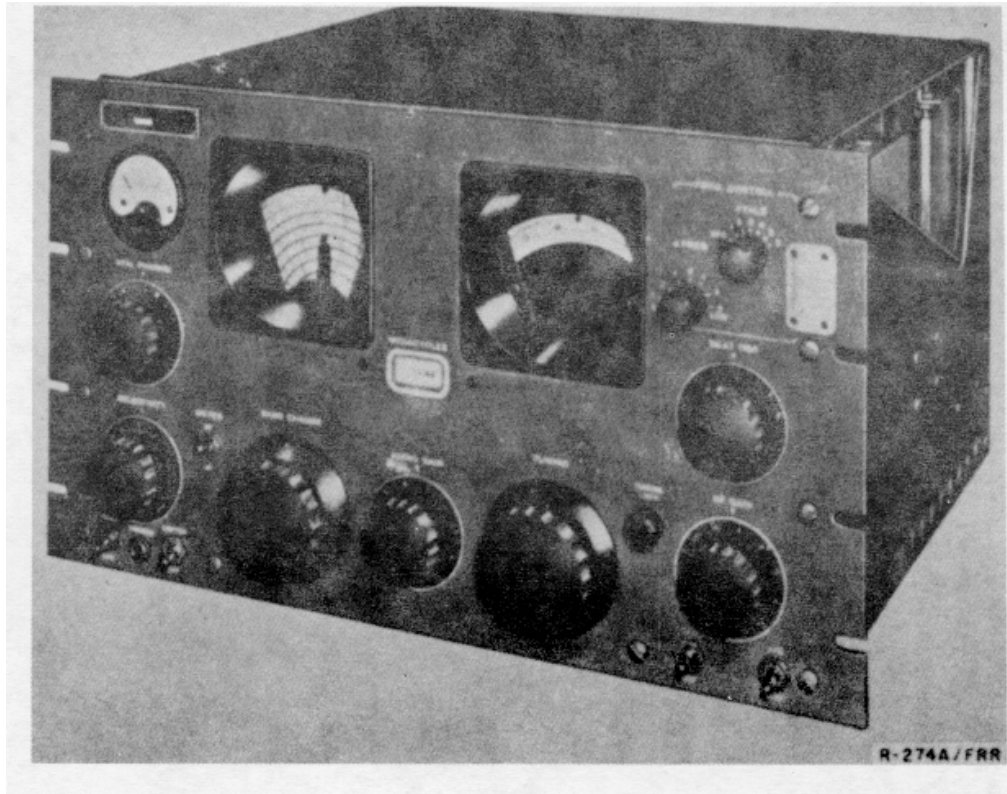

#### FUNCTIONAL DESCRIPTION:

Radio Receiver R-274A/FRR and R-274C/FRR are operationally the same as Radio Receiver R-274/FRR, but differ greatly in appearance and slightly in technical characteristics.

These equipments consist of a single radio receiver component with a built-in power supply. They are designed for rack-mounting in standard fixed-station 19-inch equipment bays. Frequency-shift keyed signals can be fed to radioteletype converters either at audio frequency or through coaxial cable at intermediate rf frequency.

These receivers operate on either single-wire antennas or doublets, as well as the usually more complex arrays in fixed-plant applications.

#### RELATIONSHIP TO SIMILAR EQUIPMENT:

**RADIO RECEIVER**  
**AN/FRR-type**  
**R-274A/FRR**  
**R-274C/FRR**

**TECHNICAL DESCRIPTION:**

*Frequency Range in mc:* 0.54 to 54.

*Type Modulation:* am.

*Type of Signal:* cw, tone, voice, frequency-shift keyed radioteletype (with additional equipment).

*Power Requirements:* 130 w, 90-270 v, 50-cy ac.

*Major Unit:* 1 R-274A/FRR 21 3/8" x 12 3/4" x 17 1/8" 66 lbs.

**TUBES, CRYSTALS, TRANSISTORS:**

**REFERENCE DATA AND LITERATURE:**

TM 11-851.

**RADIO RECEIVING EQUIPMENT  
AN/FRR-type  
RC-256**

5 December 1958  
Cog. Serv.: USA FSN:  
USA Line Item No:

	USA	USN	USAF	USMC
<b>STATUS OR TYPE CLASS.:</b>			A/Std	

**Manufacturer:**

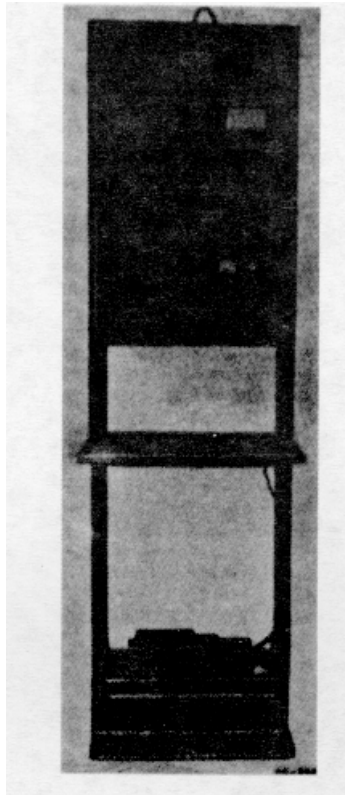

**FUNCTIONAL DESCRIPTION:**

Radio Receiving Equipment RC-256 is an amplitude-modulated radio equipment and is used with, but not part of, Radio Transmitter RC-257 to form a single-channel radio terminal station for point-to-point and air-to-ground communication.

The input impedance matches Radio Frequency Cable RG-11/U for operation with Antenna Equipment RC-81 or RC-81C.

This receiver provides continuous tuning over its entire frequency range, and for precise calibration, a Frequency Meter BD-1420 is supplied.

**RELATIONSHIP TO SIMILAR EQUIPMENT:**

None.

**RADIO RECEIVING EQUIPMENT**

AN/FRR-type

RC-256

**TECHNICAL DESCRIPTION:***Frequency Range in mc:* 100 to 156.

Type Modulation: am.

Type of Signal: voice, cw, icw, and tone.

Power Output: 1.2 w into 600-ohm impedance (max).

Power Requirements: 100 w, 110-125/220-250 v 60-cy l-phase ac.

*Major Units:*

1	Frequency Meter BC-1420	7" x 19" x 11 1/2"	35 lbs.
1	Radio Receiver BC-1421	10 15/32" x 19" x 13 9/16"	38 lbs.
1	Rectifier RA-147	8 23/32" x 19" x 6 31/32"	26 lbs.
1	Switching Panel PN-56	6 31/32" x 19 1/8"	7.5 lbs.

**TUBES, CRYSTALS, TRANSISTORS:**

None.

**REFERENCE DATA AND LITERATURE:**

TO 16-40 RC-256-3-4-6.

RADIO SET  
AN/FRR-type  
SCR-244, -A, -B, -C

1 July 1958

Cog. Serv.: USA FSN: 5820-194-2994

USA Line Item No: 651100

USA USN USAF USMC

STATUS OR TYPE CLASS.:

Manufacturer: Hammarlund Manufacturing Co. Inc.

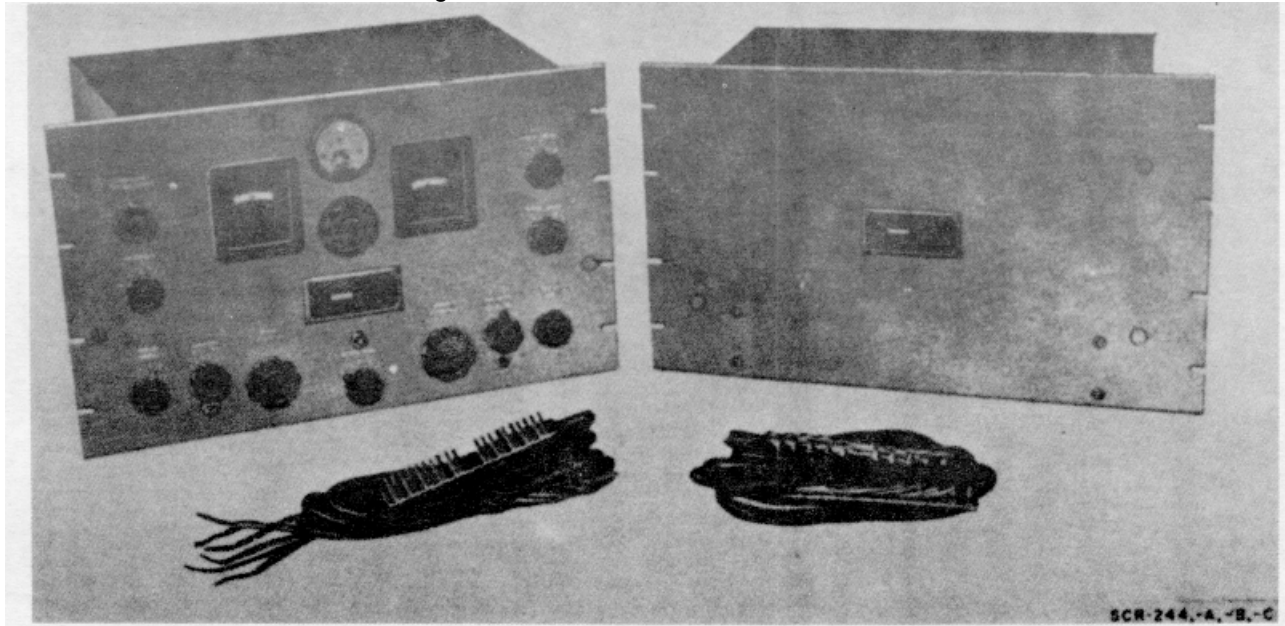

FUNCTIONAL DESCRIPTION:

Radio Sets SCR-244, -A, -B, and -C are general purpose, am (voice and cw) receiving equipments used for communication, monitoring, or intercept purposes in the mf and bhf bands in fixed station applications.

This equipment consists essentially of a commercial (Hammarlund Super-Pro) communications type receiver, plus a power supply. It may be operated as table top equipment or installed in a standard relay rack. When cabinet inclosed it may be mounted on appropriate shock mounts and operated in vehicles, if a proper power source is available.

Automatic and manual volume control are provided.

Antenna and accessory items are included with this set.

RELATIONSHIP TO SIMILAR EQUIPMENT:

None.

Frequency Range in mc: 0.54 to 20.0 in 5 bands.

Type Modulation: am.

Type of Signal: voice, tone, cw.

Power Requirements: 105-120 v 50/60 cy ac.

Major Units:

RA-9410 1/2" x 10" x 19"

60 lbs.

BC-1004

10 1/2" x 15 3/8" x 19"

55.



RADIO SET  
AN/FRR-type  
SCR-244, -A, -B, -C

TUBES, CRYSTALS, TRANSISTORS:

REFERENCE DATA AND LITERATURE:

TM 11-866.  
(USA) 71-1525-A.

**RADIO TRANSMITTING SET  
AN/FRT-6**

26 November 1958

Cog. Serv.: USA FSN: 5820-642-7784

USA Line Item No:

STATUS OR TYPE CLASS.:	USA	USN	USAF	USMC
			L/Std	

Manufacturer: Collins Radio Co.

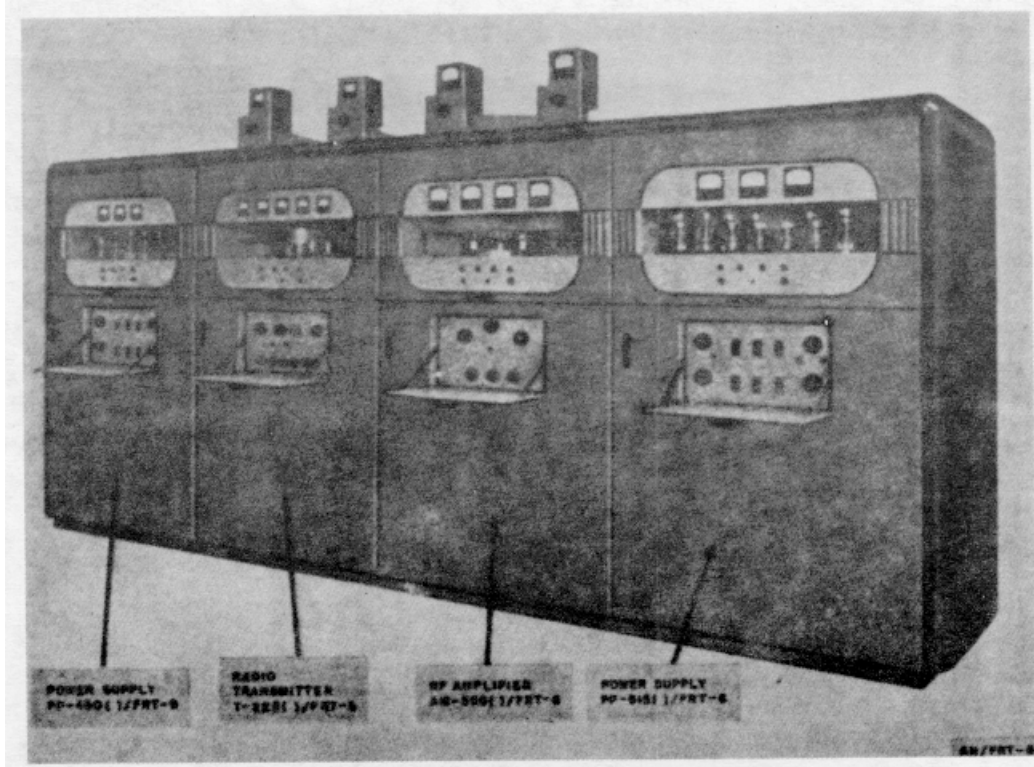
**FUNCTIONAL DESCRIPTION:**

Radio Transmitting Set AN/FRT-6 is a long-range, high-frequency facility designed for shore-based communications service. It provides an output power of 40 kilowatts for ON-OFF radiotelegraph, frequency-shift telegraph or teletypewriter, and facsimile transmission.

This equipment is principally employed for shore-to-ship and point-to-point communication. The high radio frequency power output makes it suitable for transmission over long and difficult circuits.

The set provides 10 preset, crystal-controlled channels and has a stabilized variable frequency oscillator. It is intended for optimum operation into an antenna with an impedance of 600 ohms.

The transmitter may be operated without using the main radio frequency amplifier section to provide a 15-kilowatt output, instead of the normal 40-kilowatt output, for operation to medium distances or for emergency use.

Radio Transmitting Set AN/FRT-6 is similar functionally to Radio Transmitting Equipment TEC.

**RELATIONSHIP TO SIMILAR EQUIPMENT:**

None.

**RADIO TRANSMITTING SET  
AN/FRT-6**

**TECHNICAL DESCRIPTION:**

*Frequency Range in mc:* 4 to 26.

*Frequency Control:* crystal or stabilized oscillator.

*Type of Signal:* cw, rtt, fax.

*Type Modulation:* am, fm.

*Keying:* max keying speed 400 wpm, A1, F1.

*Nominal Power Output:* 40 kw.

*Power Requirements:* 86 kw (normal), 27.5 kw (low power); 207-253-v 60-cy. 3-phase ac; and 115-v 60-cy 1-phase ac for crystal oven.

*Major Units:*

1	KY45/FRT-5	10 1/2" x 19" x 15 1/8"	49 lbs.
1	ea C-587 and 598/FRT-5	38 1/2" x 30 1/4" x 14 1/4"	435 lbs.
1	ea PP-44 and 490/FRT-5	8 3/4" x 19" x 15 1/8"	1820 lbs.
1	TF-124/FRT-6	55 3/4" x 58 1/2" x 30 1/2"	3010 lbs.
1	T-255/FRT-5	91 1/2" x 46 5/8" x 37 1/2"	2108 lbs.
1	PP-515/FRT-6	91 1/2" x 46 5/8" x 37 1/2"	2030 lbs.
1	TF-122/U	18 1/2" x 36 1/2" x 14 3/4"	527 lbs.
1	AM-350/FRT-6	91 1/2" x 46 5/8" x 54 1/2"	2550 lbs.
1	O-91/FRT-5	10 1/2" x 19" x 15 1/8"	35 lbs.

**TUBES, CRYSTALS, TRANSISTORS:**

None.

**REFERENCE DATA AND LITERATURE:**

NAVSHIPS 91263.

USN RE-13A900B.

RADIO TRANSMITTING SET  
AN/FRT-15A

26 November 1958

Cog. Serv.: USA FSN: 5820-548-3809

USA Line Item No:

	USA	USN	USAF	USMC
STATUS OR TYPE CLASS.:			L/Std	

Manufacturer: Radiomarine Corporation of America

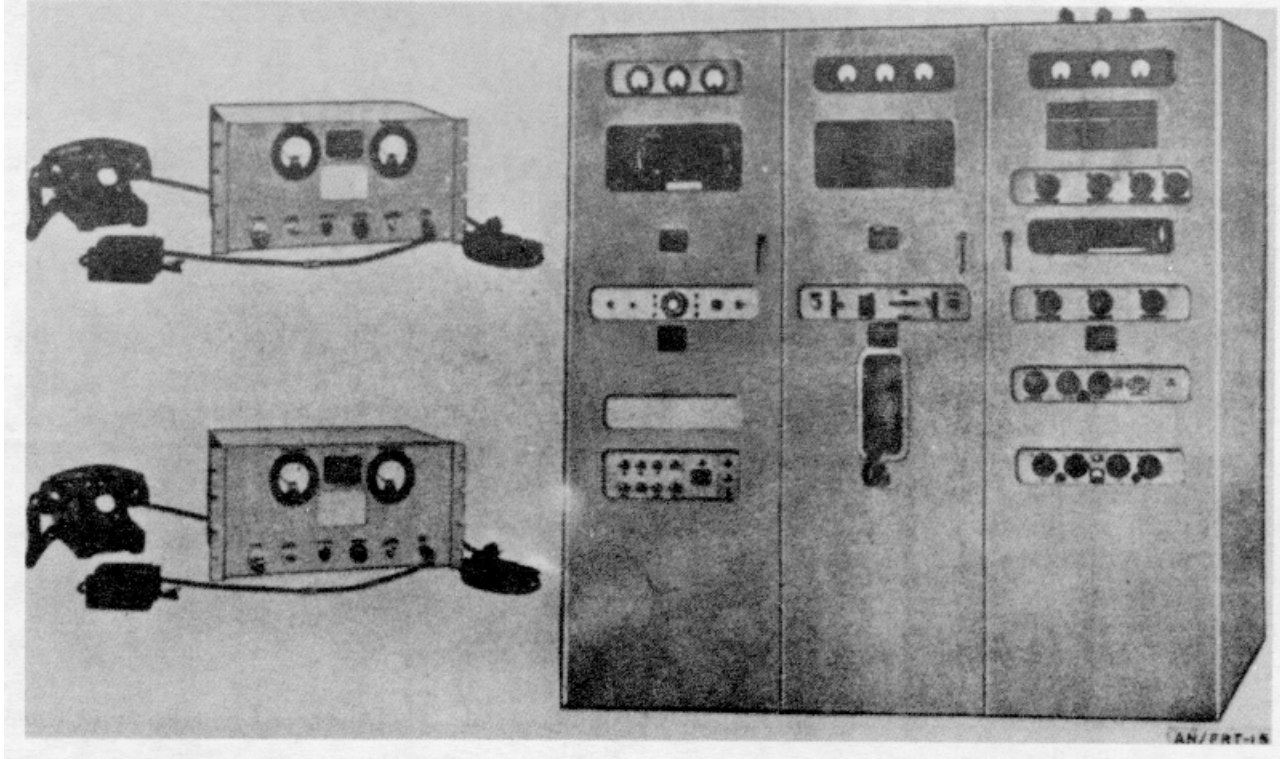
**FUNCTIONAL DESCRIPTION:**

Radio Transmitting Set AN/FRT-15A is a general service unit intended for use in naval shore or air force ground installations. It is suitable for point-to-point and aeronautical ground station operation on a number of selected frequency channels.

The set has been designed for operation of ambient temperatures between 0° and 50° centigrade (32° and 122° F.) and in a relative humidity up to 95 percent.

This equipment is capable of continuous operation on continuous-wave, modulated continuous wave, telephone, frequency-shift keying (with phase modulation, if desired), or facsimile. The appropriate frequency may be selected automatically either locally or remotely.

Radio Transmitting Set AN/FRT-15A is identical in appearance, rating, operation, and application with Radio Transmitting Set AN/FRT-15 but differs in certain minor details of construction.

**RELATIONSHIP TO SIMILAR EQUIPMENT:**

## RADIO TRANSMITTING SET AN/FRT-15A

### TECHNICAL CHARACTERISTICS:

*Frequency Range in mc:* 2 to 30.

*Tuning:* Continuous over entire range

*Number of Frequency Channels:* 12.

*Number of Preset Frequencies:* 11.

*Number of Manually Tuned Frequencies:* 1.

*Type of Frequency Control:* Crystal or master oscillator.

*Frequency Selection:* Any one frequency by use of telephone-type dial, either locally or remotely.

*Time to Change Preset Frequency and or Mode of Operation:* Less than 15 sec.

*Type Emission:* cw, mcw, voice modulated, fsk, fax.

*Type Modulation:* am.

*Input:* -25 to 0 db into 500 ohm impedance.

*Audio Response:* -Flat with  $\pm 3$  db from 15 cps to 3, 500 cps.

*Compression:* Above 70% modulation; 10 db increase in input results in less than 3 db change in modulation level.

*Modulation Capability:* 100%.

*Type of Frequency-shift Circuit:* Reactance modulated oscillator.

*Nominal Oscillator Frequency:* 200 kc.

*Deviation:* Adjustable from 0 to  $\pm 1, 000$  cps.

*Deviation Response:* Linear with respect to de input voltage, within 5%.

*Stability:* Within 5% above 200 cps, within 10 cps below 200 cps freq shift.

*Frequency of Phase Modulation:* 200 cps per sec  $\pm 5\%$ .

*Placement of Antenna:* 1 radian  $\pm 0.1$  radian.

*Phototransmission:*

Input Signal: Peak magnitude of + 1 to +20 v.

Input Impedance: 600 ohms  $\pm 10\%$ .

Maximum Deviation: Zero signal, 1,000 cps; peak signal, +1,000 cps.

*Response:*

Static: Linear within 5% with respect to an input signal, over a 30 db range below any value between +1- and +20-v de.

Dynamic: Peak of any ac signal voltage of 0 to 2, 000 cps is with 2 db of dc voltage to cause some deviation.

*Keying:*

*Type:* Polar or neutral.

*Range:* 30- to 135-v de.

*Control:* Local or remote.

*Circuit:* Electronic.

*Speed:* cw ON-OFF or freq shift up to 500 wpm; mcw, up to 50 wpm.

*Control:* Local or remote.

*Local Control:* Start and stop by manual switches; emission and channel selection by telephone-type dial.

*Remote Control:* Initial start at transmitter only; restart, standby, stop, emission, and channel selection by telephone-type dial.

*Nominal RF Output Power:*

2 to 12 Mc: 3, 000 w.

12 to 26 Mc: 2, 500 w.

26 to 30 Mc: 2, 000 w.

**RADIO TRANSMITTING SET  
AN/FRT-15A**

*Output Transmission Line:* Balanced; impedance 70 to 800 ohms; max standing wave ratio with load connected, two to one.

*Crystals, Channel Frequency:*

Type: CR-27/U.

Number Required: 1 to 10.

Frequency Range: 1,800 to 3,800 kc.

Operating Temperature: 75° C. ±1°C.

*Master Oscillator:*

Type: rf oscillator 0-140A/FRT-15.

Frequency Range: 1,800 kc to 4,000 kc.

*Power Requirements:*

Power Supply Group OA-206A/FRT-15; 220-v 50-60 cy 3-phase ac.

*Transmitter Control:* C-745A/FRT-15: 110-v 50-60 cy 1-phase ac.

*Major Units:*

1	OA-206A/FRT-15	25 15/16" x 31" x 83 15/16"	1,175 lbs.
1	OA-204A/FRT-15	28 15/16" x 31" x 83 15/16"	975 lbs.
1	OA-2050A/FRT-15	28 15/16" x 31" x 83 15/16"	925 lbs.

**TUBES, CRYSTALS, TRANSISTORS:**

**REFERENCE DATA AND LITERATURE:**

NAVSHIPS 91848(A).

TS-2176.

RADIO TRANSMITTING SET  
AN/FRT-17

15 March 1962

Cog. Serv.: USA FSN: 5820-647-6383

USA Line Item No:

USA    USN    USAF    USMC

STATUS OR TYPE CLASS.:

Manufacturer: Federal Telephone and Radio Co.

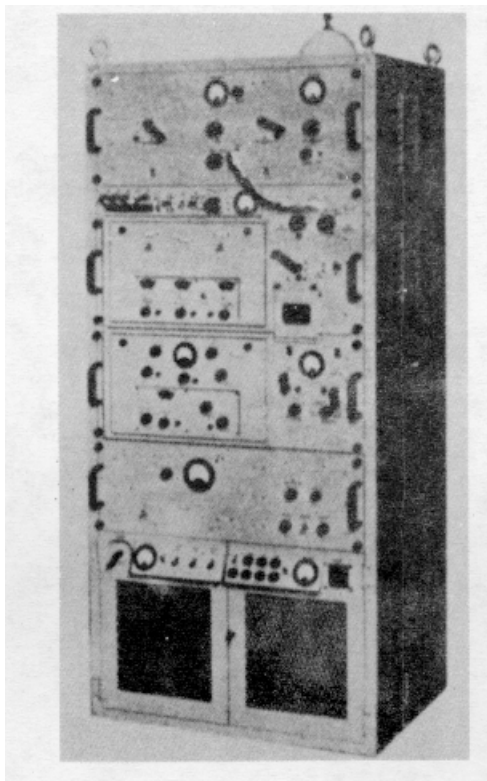
**FUNCTIONAL DESCRIPTION:**

Radio Transmitting Set AN/FRT-17 is a shore installation transmitter for shore-to-ship and point-to-point operation. Operation of the set is based on the principle of generating, at an exact sub-multiple of the desired output frequency, a stable, low energy rf signal. The frequency of the signal is multiplied and the power amplified to produce the desired rf carrier. The resultant rf energy is then radiated from a suitable antenna.

**RELATIONSHIP TO SIMILAR EQUIPMENT:**

The AN/FRT-17 can be used as a driver for the AN/FRT-18 3 kw amplifier with no circuit modification necessary.

**RADIO TRANSMITTING SET  
AN/FRT-17**

**TECHNICAL DESCRIPTION:**

*Frequency Range:* 2-30 mc.

*Frequency Multiplication:* 2-8 times.

*First Frequency Multiplier Range:* 2-15 mc.

*Second Frequency Multiplier Range:* 2-30- mc.

*Frequency Control:* Crystal or stabilized oscillator.

*Emission:* A1, A2, A3, F1.

*Keying Speed:* Up to 600 wpm for either A1 or F1, up to 100 wpm for A2.

*Nominal Power Output:* 500 w (all types of emission).

*Heat Dissipation:* 2,000 w.

*Power Factor:*

Stand By: 97.3 percent.

Normal Operation: 98.8 percent with A1 or F1; 98.2 percent with A2 or A3.

*Operating Power Required:* 115/230 volts, 50-60 cps, single phase.

*Total Power Required:* 115/230 volts, 50-60 cps, single phase.

*Total Power Dissipation:*

Operate: 3050 w for A1 and F1; 2970 V for A2 and A3.

Stand By: 600 w for A1 and F1; 600 w for A2 and A3.

*Major Units:*

	AN/FRT-17	73 5/16" x 27 1/4" x 32"	1500 lbs.
1	O-212/FRT	10 1/2" x 13 1/8" x 19"	35 lbs.
1	MD-200/FRT	10 1/2" x 13" x 19"	29 lbs.
1	MD-201/FRT	9 7/8" x 24 9/32" x 29 9/16"	140 lbs.
1	Power Amplifier	14 29/32" x 25 5/32" x 29 9/16"	40 lbs.
1	AM-766/FRT-23	11 11/16" x 24 15/16" x 29 9/16"	50 lbs.
1	CU-362/FRT	11 49/64" x 25 13/32" x 29 9/16"	70 lbs.
1	CY-1436/FRT	73 5/16" x 27 1/4" x 32"	1136 lbs.

**TUBES, CRYSTALS, TRANSISTORS:**

None.

**REFERENCE DATA AND LITERATURE:**

NAVSHIPS 91963.



**RADIO TRANSMITTING SET  
AN/FRT-18**

15 March 1962

Cog. Serv.: USA FSN: 5820-642-6382

USA Line Item No:

USA	USN	USAF	USMC
-----	-----	------	------

---

**STATUS OR TYPE CLASS.:**

---

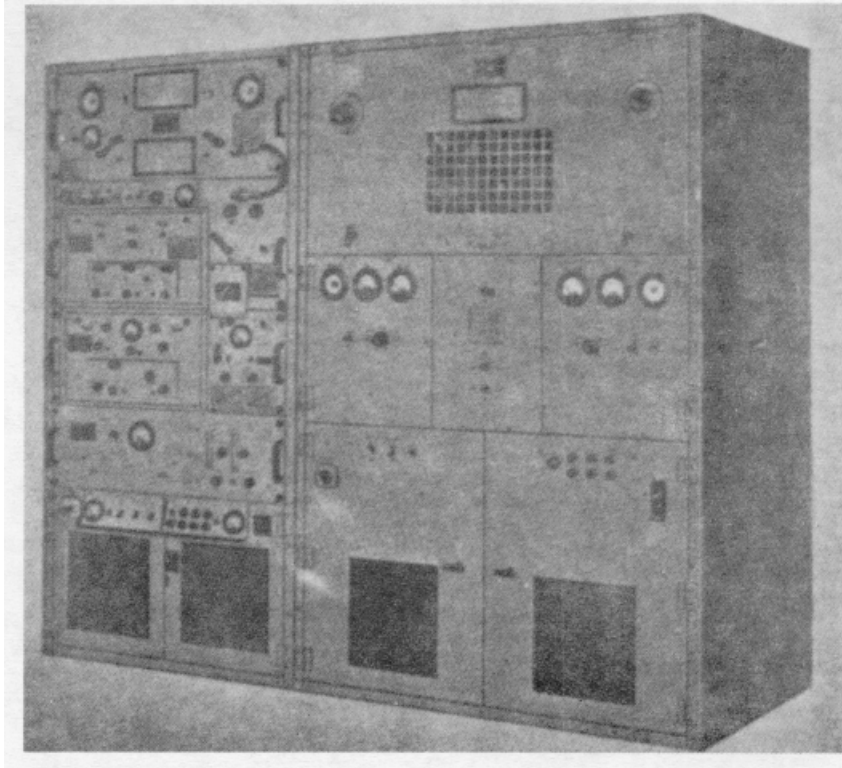
**Manufacturer:** Federal Telephone and Radio Co.**FUNCTIONAL DESCRIPTION:**

Radio Transmitting Set AN/FRT-18 is a 3-kw, shore-based unit used principally for shore-to-ship or point-to-point communication. The unit contains a 500-watt driver and a 3-kw power amplifier. The 500-watt driver may be used as a transmitter independently of the 3-kw amplifier. As a transmitter, the driver may be operated with on-off keying, frequency shift keying, modulated cw, or may be voice modulated. Facilities are provided to reduce the operating power of the driver and final power amplifier to one-half or one-fourth of normal power. Operation of the equipment is based on the principle of generating a stable low energy rf signal at an exact submultiple of the desired output frequency, then multiplying the frequency and amplifying the power of the signal in the driver to produce an rf carrier. The resultant rf energy is amplified to the desired output power and radiated from a suitable antenna.

**RELATIONSHIP TO SIMILAR EQUIPMENT.**

None.

## RADIO TRANSMITTING SET AN/FRT-18

### TECHNICAL DESCRIPTION:

*Frequency Range:* 2-30 mc.

*Frequency Multiplication:* 2 to 8 times.

*First Frequency Multiplier Range:* 2-15 mc.

*Second Frequency Multiplier Range:* 2-30 mc.

*Type of Frequency Control:* Crystal or stabilized oscillator.

*Type of Emission:*

A1 (Unmodulated carrier on-off): Driver or driver plus final power amplifier.

A2 (Tone modulated carrier on-off): Driver only.

F1 (Frequency shift keying, unmodulated): Driver or driver plus final power amplifier.

F2 (Frequency shift keying, phase modulated): Driver or driver plus final power amplifier.

A3 (Radio Telephone): Driver only.

F4 (Facsimile, photo): Driver or driver plus final power amplifier.

*Keying Speed:* Up to 600 wpm for either on-off or frequency shift emission. Up to 100 wpm for modulated cw.

*Nominal lower Output:* 500 w, driver only; 3-kw, driver plus final power amplifier.

*Operating Power Requirements:* Driver 115/230v  $\pm 10$  percent, 50/60cy  $\pm 5$  percent, single phase; final power amplifier 230v  $\pm 10$  percent, 50/60cy  $\pm 5$  percent, three phase.

*Approximate Input Power:*

A1 and FSK (Driver and final power amplifier)

*Operate*

*Standby*

A1 and FSK (Driver)

9.3 kw

2.6 kw.

A2 or A3 (Driver)

3050 w

600 w.

2970 w

600 w.

*Major Units:*

1	0-212/FRT	10 1/2" x 19" x 13 1/8"	35 lbs.
1	MD-200/FRT	10 1/2" x 19" x 13"	29 lbs.
1	MD-201/FRT	9 7/8" x 29 9/16" x 24 9/32"	140 lbs.
1	Power amplifier	14 29/32" x 29 9/16" x 25 5/32"	40 lbs.
1	AM-766/FRT-23	11 11/16" x 29 9/16" x 24 15/16."	50 lbs.
1	CU-362/FRT	11 49/64" x 29 9/16" x 25 13/32"	70 lbs.
1	CY-1436/FRT	73 1/16" x 32" x 27 1/4"	1136 lbs.
1	AM-897/FRT	74 1/4" x 46 3/32" x 30"	2000 lbs.

### TUBES, CRYSTALS, TRANSISTORS:

None.

### REFERENCE DATA AND LITERATURE:

NAVSHIPS 92018, Instruction Book for Radio Transmitting Set AN/FRT-18.

**RADIO TRANSMITTING SET  
AN/FRT-22**

1 March 1964

Cog. Serv.: USA FSN: 5820-570-5480

USA Line Item No: 692450

	USA	USN	USAF	USMC
<b>STATUS OR TYPE CLASS.:</b>	Std A		L/Std	

Manufacturer: Collins Radio Co.

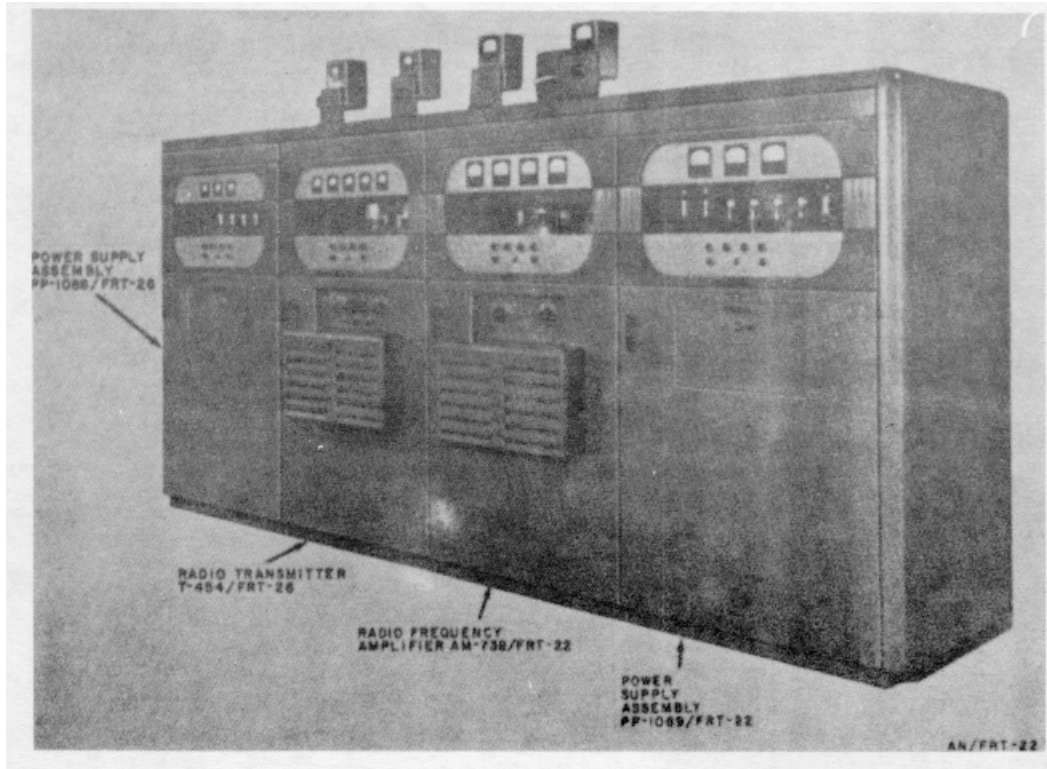

**FUNCTIONAL DESCRIPTION:**

Radio Transmitting Set AN/FRT-22 is a high-power, hf, fixed station radio equipment used for handling cw radiotelegraph, frequency-shift teletypewriter, or facsimile traffic over long distances.

It consists essentially of a transmitter (having two rf oscillators, a frequency-shift keyer, and a power supply), an amplifier, and two power assemblies. Each of these components is housed in a metal cabinet; these four cabinets are bolted together to form a single unit.

This equipment is the primary operating component of Coded Facility-344 (TB SIG 322-334).

**RELATIONSHIP TO SIMILAR EQUIPMENT:**

None.

**RADIO TRANSMITTING SET  
AN/FRT-22**

**TECHNICAL DESCRIPTION:**

*Frequency Range in Mc:* 4 to 26.5.

*Type Modulation:* am, fm.

*Type of Signal:* cw, fsk, ssb.

*Power Output:*

Ssb: 30 kw.

Cw, fsk: 40 kw.

*Power Requirements:* 84.5 kw, 230-v (+10%) 50/60-cy 3-phase ac.

*Major Units:*

1	KY-45/FRT-5	19" x 15 1/8" x 10 1/2"	
1	PP-454/FRT-5	19" x 15 1/8" x 8 3/4"	
1	PP-108/FRT-26	79 5/16" x 43 1/2" x 37 11/16"	1800 lbs.
1	PP-1089/FRT-22	79 5/16" x 43 1/2" x 37 11/16"	2000 lbs.
1	TF-196/FRT-26	32" x 42" 19 1/8"	605 lbs.
1	AM-738/FRT-22	91 9/16" x 43 1/2" x 59 7/16, "	2650 lbs.
1	T-454/FRT-26	91 9/16" x 43 1/2" x 42 7/16"	2200 lbs.
1	O-91/FRT-5	19" x 15 1/8" x 10 1/2"	
1	O-270/FRT-26	19" x 10 13/16, " x 5 1/4"	

**TUBES, CRYSTALS, TRANSISTORS:**

None.

**REFERENCE DATA AND LITERATURE:**

TM 11-847.

MIL-R-11181.

RADIO TRANSMITTING SET  
AN/FRT-24

15 March 1962  
Cog. Serv.: USA FSN:  
USA Line Item No:

---

USA    USN    USAF    USMC

---

---

**STATUS OR TYPE CLASS.:**

---

Manufacturer: COL (13499)

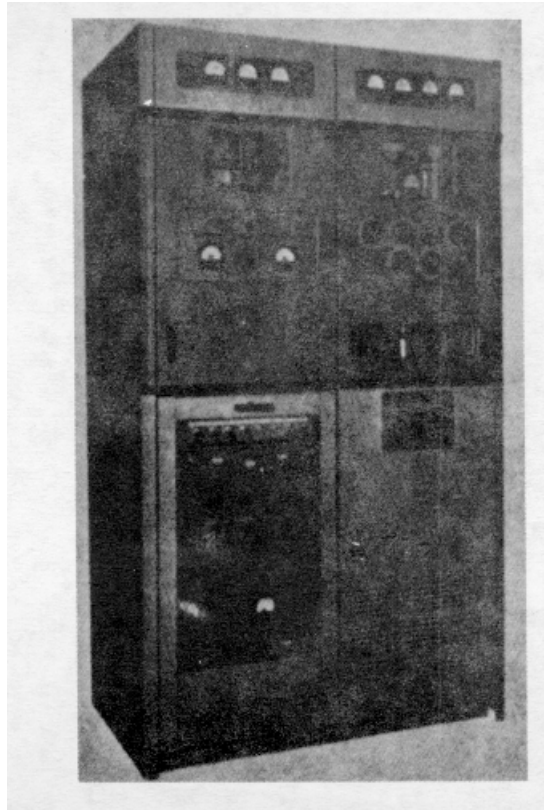

**FUNCTIONAL DESCRIPTION:**

Radio Transmitting Set AN/FRT-24 is for shore-to-ship, ground station-to-aircraft, point-to-point, or any other similar transmitting application. The set provides shore station installation with reliable communications under wide variations in climate conditions. Operation of the set is based on the principle of generating a stable low power rf signal at an exact submultiple of the desired output frequency multiplying the frequency, and amplifying the power of this signal to produce the desired rf carrier. The carrier is modulated in accordance with the intelligence to be transmitted.

**RELATIONSHIP TO SIMILAR EQUIPMENT.**

None.

**RADIO TRANSMITTING SET  
AN/FRT-24**

**TECHNICAL DESCRIPTION:**

*Frequency Range:* 2-30 mc.

*Number of Channels:* 9.

*Number of Tuning Bands:* 8.

*Type of Frequency Control:* Crystal or stabilized oscillator.

*Type of Emission and Modulation Capability:* A1 Carrier ON-OFF), A3 (phone); 100 percent.

*Keying Speed:* 600 wpm (240 dot cps).

*Nominal Carrier Output:*

A1 Emission: 250 w, 500 w, or 1000 w into a 600-ohm load, with a max swr of 2 to 1.

A3 Emission: 250 w, 500 w, or 1000 w into a 600-ohm load, with a max swr of 2 to 1.

*Frequency Stability:*

Crystal Oscillator: .003 percent.

RF Oscillator O-243/FRT-24; .004 percent  $\pm$ 240 cps.

*Distortion:* Less than 5 percent total harmonic distortion at 1000 cps and 90 percent modulation when clipping is not used.

*Noise:* At least 40 db below 100 percent modulation.

*Operating Power Requirements:* 230/208 v  $\pm$ 10 percent, 50/60 cy +5 percent, single phase.

*Input Power:*

Standby: 20 w.

Filaments on, cw: 900 w.

Filaments on, phone: 1000 w.

Carrier on, cw: 3100 w.

Carrier on, phone (no modulation): 3700 w.

Carrier on, phone (100 percent modulation): 4500 w.

*Major Units:*

1	T-440/FRT-24	83" x 46 7/8" x 31 3/4"	1500 lbs.
1	O-243/FRT-24	10 15/32" x 18 3/16" x 16 13/16"	33 lbs.
1	PP-454/FRT-5	8 3/4" x 19" x 15 1/8"	88 lbs.
2	C-1362/FRT-24	10 7/8" x 21 1/8" x 11"	50 lbs.

**TUBES, CRYSTALS, TRANSISTORS:**

**REFERENCE DATA AND LITERATURE:**

NAVSHIPS 92223(A).

RADIO TRANSMITTING SET  
AN/FRT-26

1 July 1958

Cog. Serv.: USA FSN: 5820-503-3306

USA Line Item No: 692453

USA USN USAF USMC

## STATUS OR TYPE CLASS.:

Manufacturer: Collins Radio Co.

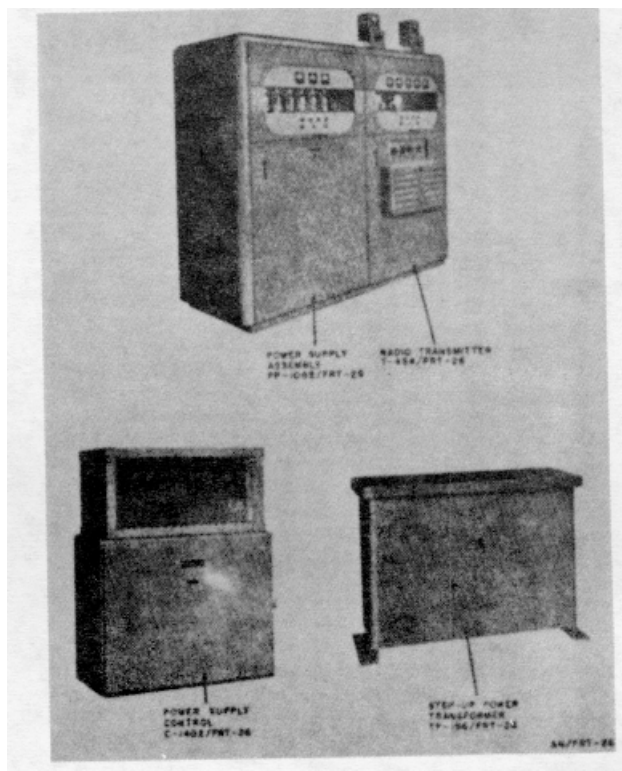

## FUNCTIONAL DESCRIPTION:

Radio Transmitting Set AN/FRT-26 is a medium-power, hf fixed station radio equipment used for handling cw radio telegraph, radioteletype, or facsimile traffic over long distances.

It consists essentially of a transmitter and its power supply (housed in two metal cabinets bolted together to form a single unit), a high-voltage power transformer, and a power control. The transmitter cabinet contains two rf oscillators, a frequency-shift keyer, and a power supply.

This equipment is the primary operating component of Coded Facility-333 (TB SIG 322-333).

## RELATIONSHIP TO SIMILAR EQUIPMENT:

**RADIO TRANSMITTING SET  
AN/FRT-26**

**TECHNICAL DESCRIPTION:**

*Frequency Range in mc:* 4 to 26.5

*Type Modulation:* am, fm.

*Type of Signal:* cw, fsk.

*Power Output:* 15 kw.

*Power Requirements:* 27.5 kw, 230 v (+ 10%) 50/60-cys 3-phase ac.

*Major Units:*

1	KY-45/FRT-5	19" x 15 1/8" x 10X"	
1	PP-454/FRT-5	19" x 15 1/8" x 8v4"	
1	PP-1088/FRT-26	9 5/16" x 43 1/2" x 37 11/16"	1, 800 lbs.
1	C-1402/FRT-26	38 1/4" x 30 1/4" x 14 3/4"	298 lbs.
1	TF-196/FRT-26	32" x 42" x 19 1/8"	605 lbs.
1	T-454/FRT-26	91 9/16" x 43 1/2" x 42 7/16"	2,200 lbs.
1	O-91/FRT-5	19" x 15 1/8" x 10 1/2"	
1	O-270/FRT-26	19" x 10 13/16 " x 5 1/4"	

**TUBES, CRYSTALS, TRANSISTORS:**

**REFERENCE DATA AND LITERATURE:**

TM 11-846.

MIL-R-11181.



RADIO TRANSMITTING SET  
AN/FRT-27

15 March 1962

Cog. Serv.: USA FSN: 5820-669-7009

USA Line Item No:

USA USN USAF USMC

## STATUS OR TYPE CLASS.:

Manufacturer: COL (13499).

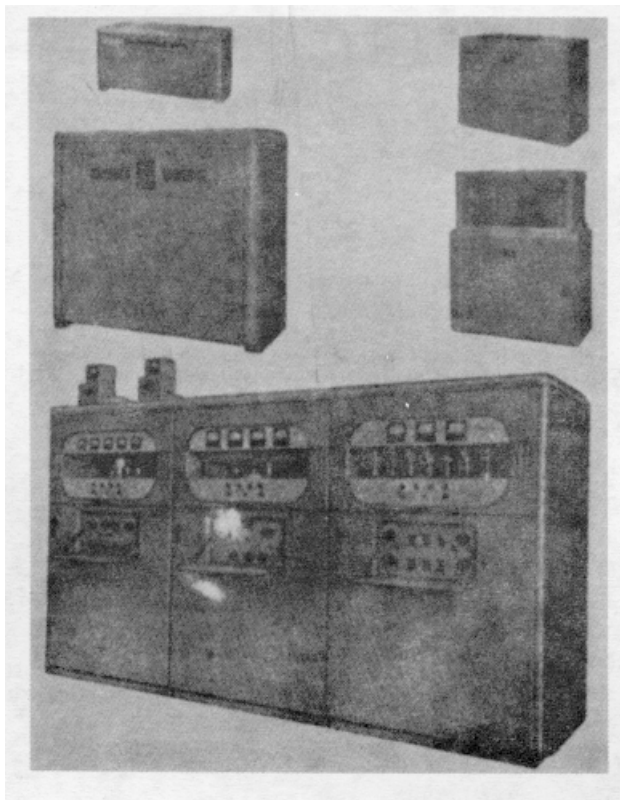

## FUNCTIONAL DESCRIPTION:

Radio Transmitting Set AN/FRT-27 is a shore installation transmitter for shore-to-ship or point-to-point communication operation. With some modification in the power amplifier circuits, the radio transmitting set will act as a power amplifier for a single sideband transmitter. In addition to single sideband transmission (A3a), the set operates on radiotelegraph (A1), radiotelephone (A3), radioteletype (F1), and facsimile (F4). The output circuit works into a balanced 2-wire transmission line having an impedance of 800 ohms and a maximum VSWR of 2 to 1 maximum.

## RELATIONSHIP TO SIMILAR EQUIPMENT:

## TECHNICAL DESCRIPTION:

*Frequency Range:* 4-26 mc.

*Type of Frequency Control:* Crystal or stabilized master oscillator.

*Type of Emission:* A1, A3, F1, F4, A3a without modification.

*Keying Speed:* Up to 400 wpm for both ON-OFF and frequency shift emission.

*Keying Input Circuit Impedance:* 25K ohms (one line grounded).

**RADIO TRANSMITTING SET  
AN/FRT-27***Nominal Carrier Output:*

A3a: 8 kw.  
 A3: 10 kw.  
 A1: 15 kw.  
 F1: 15 kw.  
 F4: 15 kw.

*Carrier Frequency Data:*

Stability:  $\pm 5$  cy per mc.  
 Noise Level:

A1, F1, F4 Emission: Less than three percent amplitude or phase modulation.  
 A3 Emission: 50 db below 100 percent modulation over a band 70-90 percent modulation

*Power Factor:*

Starting: 82.5 percent (high voltage off).  
 Standby: 80.5 percent (key open).  
 Normal Operation: 96 percent.

*Operating Power Requirements:*

Primary Power: 207-253 v, 50-60 cps, three phase.  
 Secondary Power: 110 v, 50-60 cps, single phase, nominal 250 w for operation of crystal oven heaters.  
 Regulation Tolerance:  $\pm 5$  percent voltage variation from no load to 38 kw.

*Input Wattage:*

3.3 kw: High voltage off.  
 4.5 kw: A1 (key up).  
 25 kw: A1 (key down) and A3 (unmodulated).  
 35 kw: A3 (100 percent modulated).

*Modulation Capability:* 100 percent.

*Audio Input Level:* 10  $\pm 2$  dbm into 150/600 ohm input impedance for 100 percent modulation.

*Audio Frequency Response:* Equal to or better than 2 db between 150 and 7500 cps and  $\pm 4$  db from 50 to 10,000 cps.

*Audio Frequency Harmonic Distortion:* Less than 5 percent rms for fundamental frequencies 50 to 7500 cps for values of modulation from 0 to 90 percent.

*Ambient Temperature Range:* 0 to 50° C.

*Relative Humidity:* Up to 75 percent max.

*Major Units:*

1	T-463/FRT-27	91 9/16" x 41 3/4" x 43 1/2"	1943 lbs.
1	MD-232/FRT-27	79 5/16" x 41 3/4" x 43 1/2"	1805 lbs.
1	PP-1131/FRT-27	79 5/16" x 41 3/4" x 43 1/2"	1842 lbs.
1	CU-396/FRT-27	33 1/8" x 38 1/8" x 41"	1800 lbs.
1	O-92/FRT-5	5 1/4" x 18 1/2" x 10 13/16"	15 lbs.
1	O-243A/FRT-24	10 15/32" x 18 3/16" x 16 13/16"	33 lbs.
1	KY-45/FRT-5	10 1/2" x 18 1/2" x 15 1/2"	29 lbs.
1	PP-454/FRT-5	8 3/4" x 18 1/2" x 15 1/8"	88 lbs.
1	Disconnect Box	17" x 9" x 11"	50 lbs.

**TUBES, CRYSTALS, TRANSISTORS:****REFERENCE DATA AND LITERATURE:**

NAVSHIPS 92501.

RADIO TRANSMITTER  
AN/FRT-type  
BC-329- ( )

4 December 1958  
Cog. Serv.: USA FSN:  
USA Line Item No: 657315

	USA	USN	USAF	USMC
STATUS OR TYPE CLASS.:			L/Std	

Manufacturer:

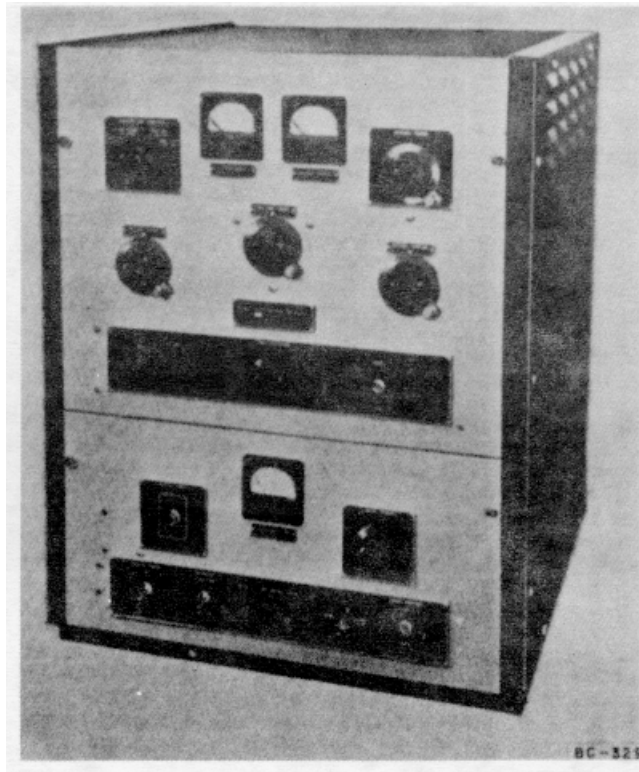

**FUNCTIONAL Description:**

Radio Transmitter BC-329 is a fixed, ground radio transmitter for short-range airport control by voice communication. Tactical use is for emergency airport traffic control at advanced air bases.

It is crystal controlled, but has a master oscillator for emergency operation at a frequency range from 0.19 to 0.41 mc. The 500-ohm impedance audio input circuit is designed for a low impedance microphone or telephone line.

The antenna output is designed for operation into a longwire antenna such as the antenna kit used with, but not part of, Tower AB-127/FR.

**RELATIONSHIP TO SIMILAR EQUIPMENT:**

None.

**RADIO TRANSMITTER**  
**AN/FRT-type**  
**BC-329-( )**

**TECHNICAL DESCRIPTION:**

*Frequency Range:* 0.2 to 0.41 mc, preset, single channel.

*Operating Range:* Short (nominal).

*Type Modulation:* am.

*Type of Signal:* Voice.

*Power Output:* 25 w.

*Power Requirements:* 560 w, 105- to 125-v, 50 to 60 cps, 1 phase ac.

*Major Unit:* 1 30 1/2" x20"

BC329 x24 1/2" 240 lbs.

**TUBES, CRYSTALS, TRANSISTORS:**

None.

**REFERENCE DATA AND LITERATURE:**

TO 16-30GRT-2-3.

RADIO TRANSMITTER  
AN/FRT-type  
BC-339-( )

1 March 1964

Cog. Serv.: USA FSN: 5820-194-0970

USA Line Item No: 657320

	USA	USN	USAF	USMC
STATUS OR TYPE CLASS.:	Std B			

Manufacturer: Barker & Williamson, Inc.

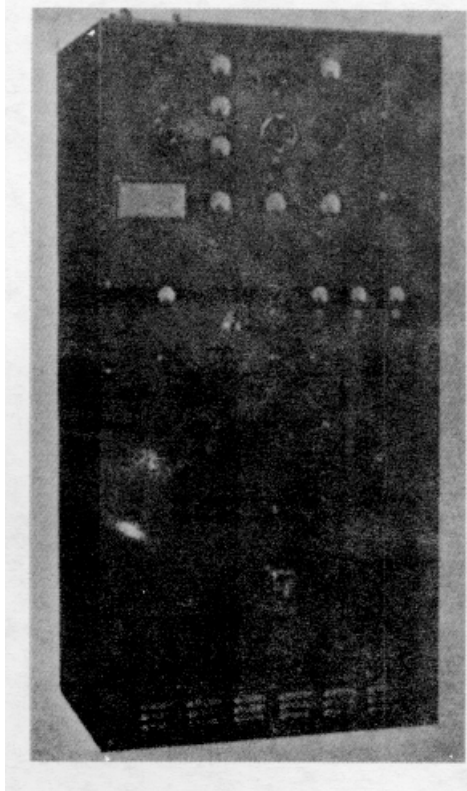

#### FUNCTIONAL DESCRIPTION:

Radio Transmitter BC-339-( ) is a high-frequency, medium power, radio-telegraph transmitting equipment used for fixed-plant, long-range, high-speed communication.

This equipment consists of a floor-type steel cabinet containing the operating components and related apparatus.

It can be operated independently, or as a driver for Power Amplifier BC340 with Rectifier RA-22 and Water Cooling Unit RU-2 to form a 10-kw radiotelegraph or radioteletype facility.

It has provision for remote starting, stopping, and keying the transmitter over a telephone pair from distances up to 6 miles away, and can be operated under such conditions at speeds of 300 wpm.

It is usually operated with a rhombic, doublet, or similar array, and operates on 220-volt ac.

#### RELATIONSHIP TO SIMILAR EQUIPMENT:

None.

**RADIO SET**  
**AN/FRT-type**  
**BC-339-( )**

**TECHNICAL DESCRIPTION:**

*Frequency Range in Mc:* 4.0 to 26.5.

*Type Modulation:* am.

*Type of Signal:* cw; or, with additional equipment, fsk.

*Power Output:* 1 kw.

*Power Requirements:*

BC 339-A, -B, -C, -F: 220-v 60-cy 3-phase ac.

BC-339-E, -G, -H, -J, -K, -L, -M: 220-v 50/60-cy 3-phase ac.

Key Up: 1,610 w.

Key Down: 4,300 w.

*Major Unit:*

1 BC-339-( )

81 5/8" x 33 3/8" x 37 1/8"

1560 lbs.

**TUBES, CRYSTALS, TRANSISTORS:**

None.

**REFERENCE DATA AND LITERATURE:**

TM 11-836.

(USA) 71-3309.

RADIO SET  
AN/FRT-type  
MW-3

5 December 1958  
Cog. Serv.: USA FSN:  
USA Line Item No:

	USA	USN	USAF	USMC
STATUS OR TYPE CLASS.:			Std	

Manufacturer: Westinghouse Electronics Corp.

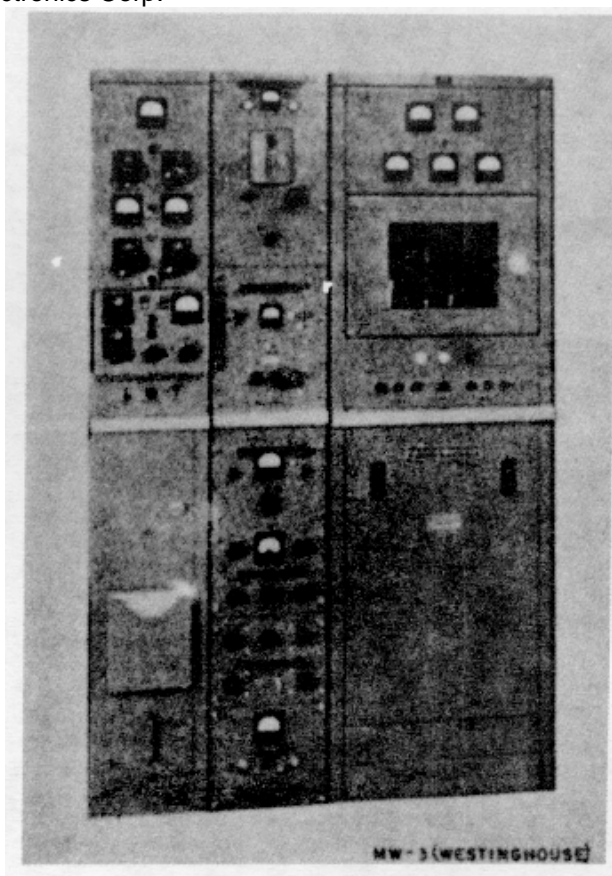

#### FUNCTIONAL DESCRIPTION:

Radio Set MW-3 is a low-distortion, single-sideband transmitter operating over the frequency range of 2 to 30 mc. It will accommodate two audio channels, each in the frequency range of 300 to 6,000 cps. This permits each channel to handle audio tones above 3,000 cps for telegraph functions.

This equipment also provides for operation as an am transmitter to operate with appropriate am receivers.

This equipment is a commercial equipment (Westinghouse Electric Co., model MW-3) procured for military use.

#### RELATIONSHIP TO SIMILAR EQUIPMENT:

None.

**RADIO SET**  
**AN/FRT-type**  
**MW-3**

**TECHNICAL DESCRIPTION:**

*Frequency Range in Mc:* 2 to 30.

*Type of Modulation:* am.

*Type of Signal:* Voice of tone.

*Power Output:* 2.5 kw (peak).

*Power Requirements:* 208/230/250-v 50/60-cy 3-phase ac.

*Major Units:*

SSB Exciter.

Linear Amplifier.

Rectifier.

**TUBES, CRYSTALS, TRANSISTORS:**

None

**REFERENCE DATA AND LITERATURE:**

None.



RADIO SET  
AN/FRT-type  
SCR-643

1 March 1964

Cog. Serv.: USA FSN:

USA Line Item No:

USA    USN    USAF    USMC

STATUS OR TYPE CLASS.:

Manufacturer:

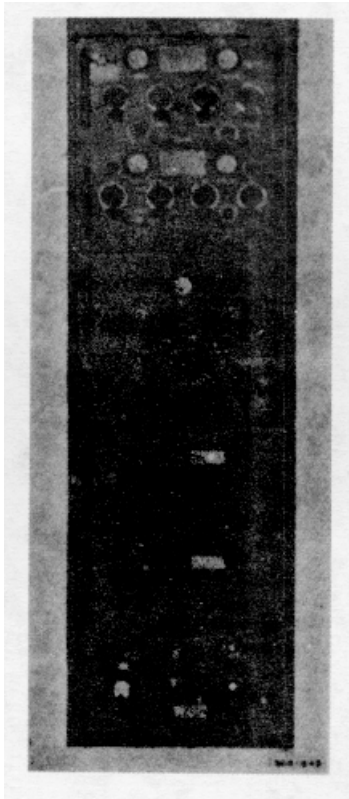

**FUNCTIONAL DESCRIPTION:**

Radio Set SCR-643 is a complete fixed station, ground installed, radio transmitting equipment for short-distance point-to-point and ground-to-air communication. It normally is used to provide two transmitting channels for vhf aircraft control net systems.

This equipment consists of two transmitters, each providing one preset, crystal-controlled voice or tone-modulated channel in the vhf range. (Only one of the two transmitters is shown on the accompanying illustration.)

This equipment can be controlled locally or with additional equipment (such as Control Unit RM-27), it can be remotely controlled at distances of up to two miles. The transmitter output matches the 72-ohm coaxial cable normally supplied as part of Antenna Equipment RC-81.

**RELATIONSHIP TO SIMILAR EQUIPMENT:**

None.

**RADIO SET**  
**AN/FRT-type**  
**SCR-643**

**TECHNICAL DESCRIPTION:**

*Frequency Range in MC:* 100 to 156.

*Type of Modulation:* am.

*Type of Signal:* Voice or mew.

*Number of Channels:* Simultaneous operation on two preset channels (one preset channel per transmitter).

*Power Output:* 50 w.

*Power Requirements:* 5.5 kva (with heaters) or 2.5 kva (without heaters), 110-120-v 50/60-cy 1-phase ac.

*Major Units:*

RC-80 and 81-A	28" x 12" x 38"	138 lbs.
PE-89-A	28" x 41" x 60"	1,140 lbs.
HO-3	48" x 66" x 60"	2,000 lbs.
BC-640-Z	21 1/4" x 72 3/8" x 20"	

**TUBES, CRYSTALS, TRANSISTORS:**

None.

**REFERENCE DATA AND LITERATURE:**

TO 40SCR-643-2.

RADIO TRANSMITTER  
AN/FRT-type  
T-4( )/FRC

1 March 1964

Cog. Serv.: USA FSN: 5820-194-0966

USA Line Item No: 657560

	USA	USN	USAF	USMC
STATUS OR TYPE CLASS.:	Obs		L/Std	

Manufacturer: Espey Manufacturing Co., Inc.

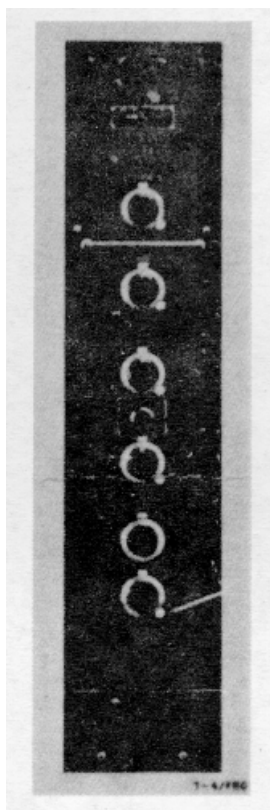

**FUNCTIONAL DESCRIPTION:**

Radio Transmitter T-4( )/FRC is a crystal-controlled, medium frequency, am (voice, cw, mcw, and frequency-shift keying) transmitting equipment, for point-to-point or ground-to-air communication in the hf band, at fixed plant applications.

This equipment consists of a radio transmitter inclosed in a steel floor-type cabinet which also contains the low-voltage power supply unit. It can be operated from a distant location by means of appropriate remote-control equipment, and is provided with a selector switch for selection of crystal or master oscillator control, or for radioteletype communication.

For cw transmission a power supply unit alone must be added; for voice communication a power supply unit and a modulator are required. It may be used with three other transmitters, a modulator, and suitable power supply equipment to constitute a multichannel station equipment.

It operates into a detla-matched doublet, a rhombic, or an equivalent antenna system, and requires a 400- or 600-ohm transmission line.

**RELATIONSHIP TO SIMILAR EQUIPMENT:**

**RADIO TRANSMITTER**

**AN/FRT-type**

**T-4( )/FRC**

**TECHNICAL DESCRIPTION:**

*Frequency Range in Mc:* 2 to 18.

*Type Modulation:* am (with Modulator Unit MD-1/FRC).

*Type Signal:* cw, mcw, freq shift keying, and voice with additional equipment.

*Power Output:* 400 w.

*Power Requirements:* 220 v 50/60-cy ac.

*Major Unit:* 1 T-4/FRC

21" x 24" x 12"

330 lbs.

**TUBES, CRYSTALS, TRANSISTORS:**

**REFERENCE DATA AND LITERATURE:**

TM 11-820.

71-3333 (USA).

**RADIO TRANSMITTER**  
**AN/FRT-type**  
**T-5( )/FRC**

1 March 1964

Cog. Serv.: USA FSN: 5820-240-0545

USA Line Item No: 657580

	USA	USN	USAF	USMC
<b>STATUS OR TYPE CLASS.:</b>	Obs		L/Std	

**Manufacturer:** Epsey Manufacturing Co, Inc.

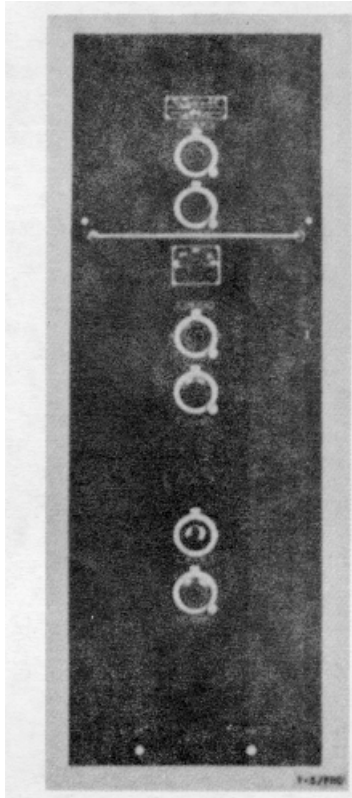

**FUNCTIONAL DESCRIPTION:**

Radio Transmitter T-5( )/FRC is a long-range, 'high-power, medium- and low-frequency, crystal-controlled transmitting station equipment. It can be used for communication by am (voice using additional equipment, cw, mcw, or frequency-shift keying) signals at fixed plant installations.

This equipment consists of a single transmitting unit and a tuning house, and it is used principally as the low-frequency rf unit of a multichannel radio system.

It operates into a 600-ohm transmission line that feeds a vertical radiator, or a Bevrige-type antenna.

A separate antenna tuning unit is provided to load the antenna. This unit is installed at the antenna end of the rf transmission line.

A low-voltage power supply unit is contained within the equipment cabinet and the high-voltage is furnished by a separate power supply, not furnished as part of this equipment. It requires 220-volt ac power.

**RELATIONSHIP TO SIMILAR EQUIPMENT:**

**RADIO TRANSMITTER**  
**AN/FRT-type**  
**T/5( )/FRC**

**TECHNICAL DESCRIPTION:**

*Frequency Range in Mc:* 0.15 to 0.55.

*Type Modulation:* am.

*Type of Signal:* cw, mcw, fsk, and voice with additional equipment.

*Power Output:* 600 w.

*Power Requirements:* 220-v 50/60 cy ac.

*Major Units:*

T-5/FRC	61" x 24" x 18"	450 lbs.
Antenna tuning unit	49 1/4" x 38 1/4" x 39 1/8"	193 lbs.

**TUBES, CRYSTALS, TRANSISTORS:**

**REFERENCE DATA AND LITERATURE:**

TM 11-820.

(USA) 71-3333; 171-225.

RADIO TRANSMITTER  
 AN/FRT-type  
 T-158( )/FRT

1 March 1964

Cog. Serv.: USA FSN: P5820-194-0969

USA Line Item No: 657740

	USA	USN	USAF	USMC
STATUS OR TYPE CLASS.:	Obs		Std	

Manufacturer: Wilcox Electric Co, Inc.

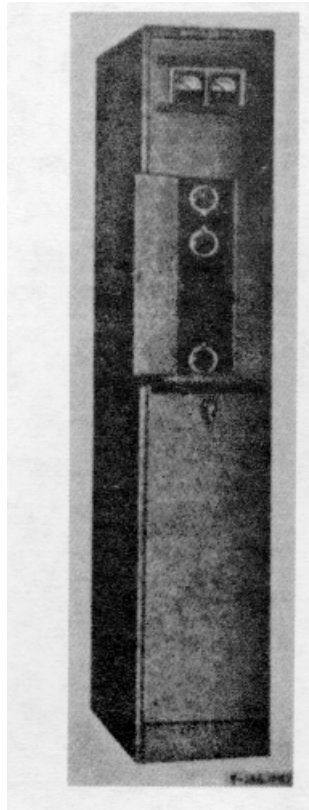

**FUNCTIONAL DESCRIPTION:**

Radio Transmitter T-158( )/FRT is crystal-controlled, am (voice, cw, mcw, and frequency-shift keying) medium-power, transmitting equipment. It is used for fixed-plant ground-to-air, and point-to-point long-range communication in the medium- and high-frequency range.

This equipment consists of a radio transmitter, exciter unit, and coil set inclosed in a floor-type cabinet and includes a radioteletype modification kit. The rectifier and modulator are not supplied as part of this equipment.

It is usually operated at a distant site by means of remote control equipment, and can use any 600-ohm antenna.

**RELATIONSHIP TO SIMILAR EQUIPMENT:**

None.

**RADIO TRANSMITTER**  
**AN/FRT-type**  
**T-158( )/FRT**

**TECHNICAL DESCRIPTION:**

*Frequency Range in mc:*

T-158, -158A, -158B/FRT: 2 to 18.

T-158C/FRT: 2 to 20.

T-158D/FRT: 2 to 26.

*Type Modulation:* am.

*Type of Signal:* cw, voice, composite transmission, fsk.

*Power Output:* 2.5 kw.

*Power Requirements:* 15 kva, 220 v 50/60-cy 3-phase ac.

*Major Units:*

1	Coil Set		6.7 lbs.
1	Exciter unit	8 3/4" x 8 1/2" x 17 1/4"	27 lbs.
1	Radio Transmitter T-158/FRT	73 3/4" x 26 1/4" x 12 1/4"	365 lbs.

**TUBES, CRYSTALS, TRANSISTORS:**

None.

**REFERENCE DATA AND LITERATURE:**

TM 11-2671.

(USA) 71-3286.



RADIO TRANSMITTER  
AN/FRT-type  
T-159/FRT

1 March 1964

Cog. Serv.: USA FSN: 5820-126-8834

USA Line Item No: 657750

USA USN USAF USMC

STATUS OR TYPE CLASS.:

Manufacturer: Collins Radio Co.

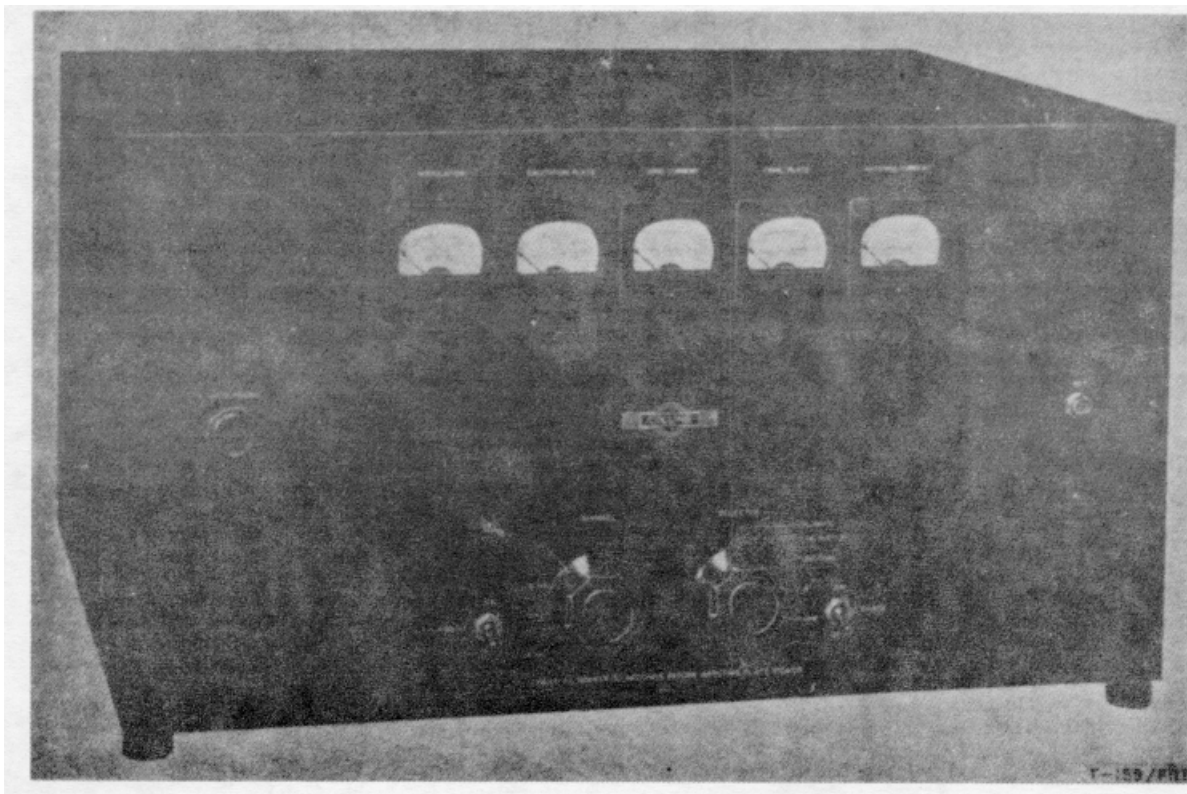

#### FUNCTIONAL DESCRIPTION:

Radio Transmitter T-159/FRT is a low-power, am (voice and cw) radio transmitting equipment used for point-to-point, homing, and fixed or mobile station use in the medium- and high-frequency bands.

This equipment consists essentially of a commercial (Collins Model 32 RA-7, -7, ), or -9) table-model transmitter contained in a steel cabinet. The complete installation includes a microphone and a telegraph key. It operates in four preset channels and may be keyed up to speeds of 60 wpm.

It is designed to work into unbalanced antennas or transmission lines, having a resistive impedance of 30 to 1,200 ohms and a reactive impedance of up to 300 ohms.

#### RELATIONSHIP TO SIMILAR EQUIPMENT:

None.

**RADIO TRANSMITTER**  
**AN/FRT-type**  
**T-159/FRT**

**TECHNICAL DESCRIPTION:**

*Frequency Range in me:* 1.5 to 15.0.

*Type Modulation:* am.

*Type of Signal:* Voice and cw.

*Power output:*

Voice: 50 w.

Cw: 75 w.

*Power Requirements:* 400 w, 115 v 50/60-cy 1-phase ac.

*Major Unit:* T-159/FRT

12" x 22" x 18"

120 lbs.

**TUBES, CRYSTALS, TRANSISTORS:**

None.

**REFERENCE DATA AND LITERATURE:**

TM 11-808.

TO 16-10-116.

Collins Type 32RA7.

**RADIO TRANSMITTER  
AN/FRT-type  
T-171( )/FR**

1 March 1964

Cog. Serv.: USA FSN: 5820-126-8852 (T-171/FR)  
5820-126-8851 (T-171A&B/FR)

USA Line Item No: 657770

	USA	USN	USAF	USMC
STATUS OR TYPE CLASS.:	Obs		Std	

Manufacturer: J. H. Bunnell & Co.

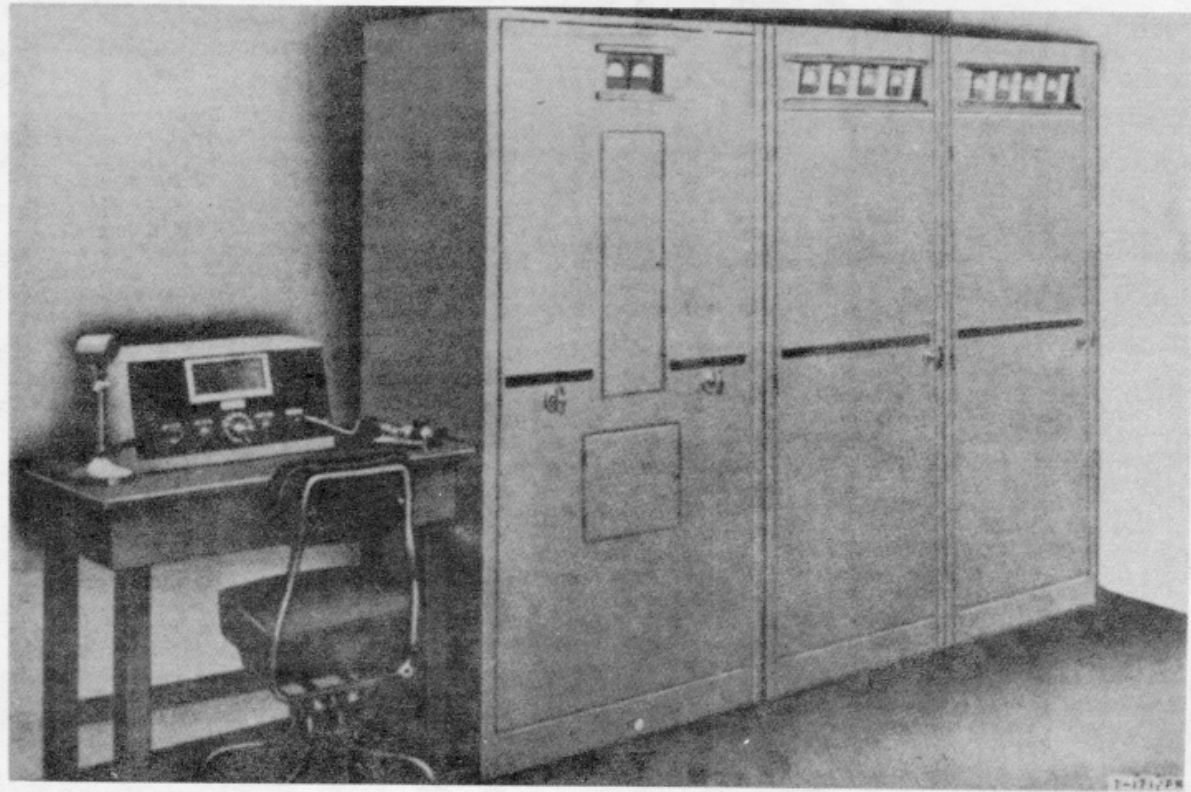

**FUNCTIONAL DESCRIPTION:**

Radio Transmitter T-171( )/FR is an IF, long-range, am (voice and cw) radio transmitting equipment used primarily for handling large traffic loads in fixed station application. It may also be used for homing.

This equipment consists essentially of a large floor type unit transmitter that is used with control and power components to form a complete radio transmitting station.

It may be operated from a distant point by means of remote control equipment and has provision for automatic keying.

The T-171/FR provides voice and cw; the T-171A/FR, cw, remote keying, and voice; and the T-171B/FR, frequency-shift keying and voice.

Power is derived from special power rectifier and supply units.

**RELATIONSHIP TO SIMILAR EQUIPMENT:**

None.

**RADIO TRANSMITTER**  
**AN/FRT-type**  
**T-171( )/FR**

**TECHNICAL DESCRIPTION:**

*Frequency Range in mc:* 0.125 to 0.525.

*Type Modulation:* am.

*Type of Signal:* cw, voice.

*Power Output:* 2,400 w.

*Power Requirements:*

1.0 amp at 4, 000 v dc.

0.125 amp at 2, 000 v dc.

0.1 amp at 500 v dc.

0.05 amp at 500 v dc.

1.0 amp at 12 v dc.

*Major Unit:* T-171( )/FR

72" x 36" x 24 3/4"

720 lbs.

**TUBES, CRYSTALS, TRANSISTORS:**

None.

**REFERENCE DATA AND LITERATURE:**

TM 11-802.

(USA) 71-3398.

RADIO TRANSMITTER  
AN/FRT-type  
T-265/FRC-10

1 March 1964

Cog. Serv.: USA FSN: 5820-249-6609

USA Line Item No: 657830

	USA	USN	USAF	USMC
STATUS OR TYPE CLASS.:	Std B			

Manufacturer: Western Electric Co.

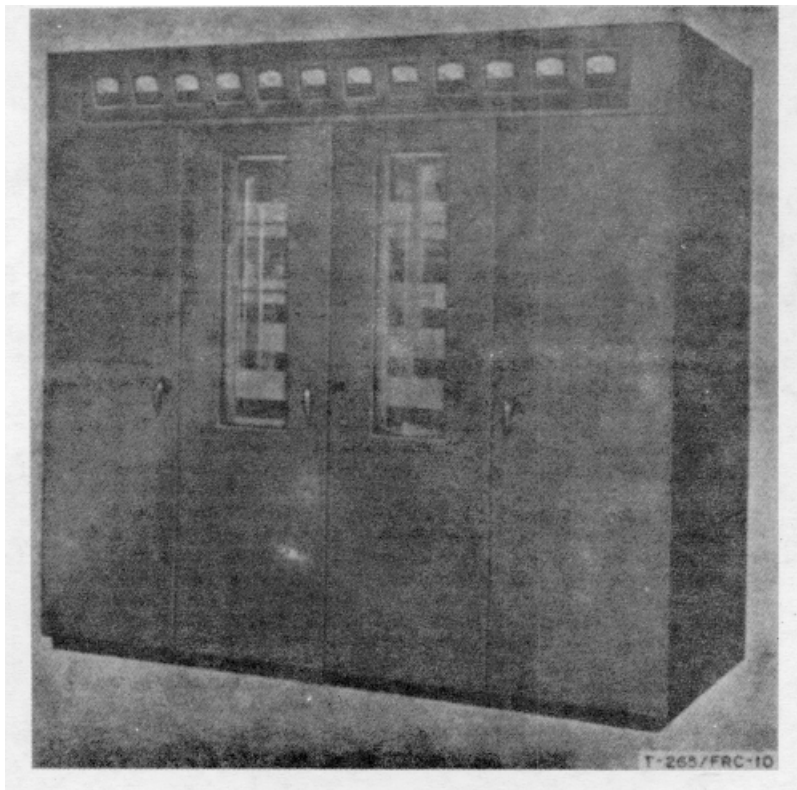

#### FUNCTIONAL DESCRIPTION:

Radio Transmitter T-265/FRC-10 is the transmitting component of the complete single-sideband Radio Set AN/FRC-10B. It is an am, ssb, twin-channel, suppressed-carrier transmitter designed for long-range point-to-point communication, and operates in the frequency range of 4 to 23 mc. It also can be arranged to transmit conventional double sideband signals.

#### RELATIONSHIP TO SIMILAR EQUIPMENT:

#### TECHNICAL DESCRIPTION:

*Frequency Range in Mc:* 4 to 23.

*Type Modulation:* Amplitude, ssb or dsb.

*Power Output:*

Single Sideband Envelope: 4 kw.

Double Sideband Carrier: 1 kw.

*Spurious Signal Suppression:* 43 db below envelope power output.

**RADIO TRANSMITTER****AN/FRT-type****T-265/FRC-10***Tone Volume:*

Speech Input Terminals: -13 to +20 dbm (+3 dbm normal).

Test-Tone Input Terminals: 0 to +20 dbm (0 dbm normal).

*Vf Input Impedance:* 600 ohms.*Frequency Accuracy:*At 4 Mc:  $\pm 0.0011\%$  or less.At 23 Mc:  $\pm 0.0026\%$  or less.*Power Requirements:* 10 kw, 230-v 50/-cy 3-phase ac; and 1 kw, 115-v 50/60-cy 1-phase ac auxiliary power.*Major Units:*

1	KS-M472-01	3 15/16" x 3 15/16" x 8"	
1	T-265/FRC-10	42 1/2" x 84" x 84"	5, 800 lbs.

**TUBES, CRYSTALS, TRANSISTORS:****REFERENCE DATA AND LITERATURE:**

TM 11-814, NAVSHIPS 92152.

RADIO TRANSMITTER  
AN/FRT-type  
T-409/FRC-30

1 March 1964

Cog. Serv.: USA FSN: 5820-545-7272

USA Line Item No: 691950

	USA	USN	USAF	USMC
STATUS OR TYPE CLASS.:			A/Std	

Manufacturer: Western Electric Co.

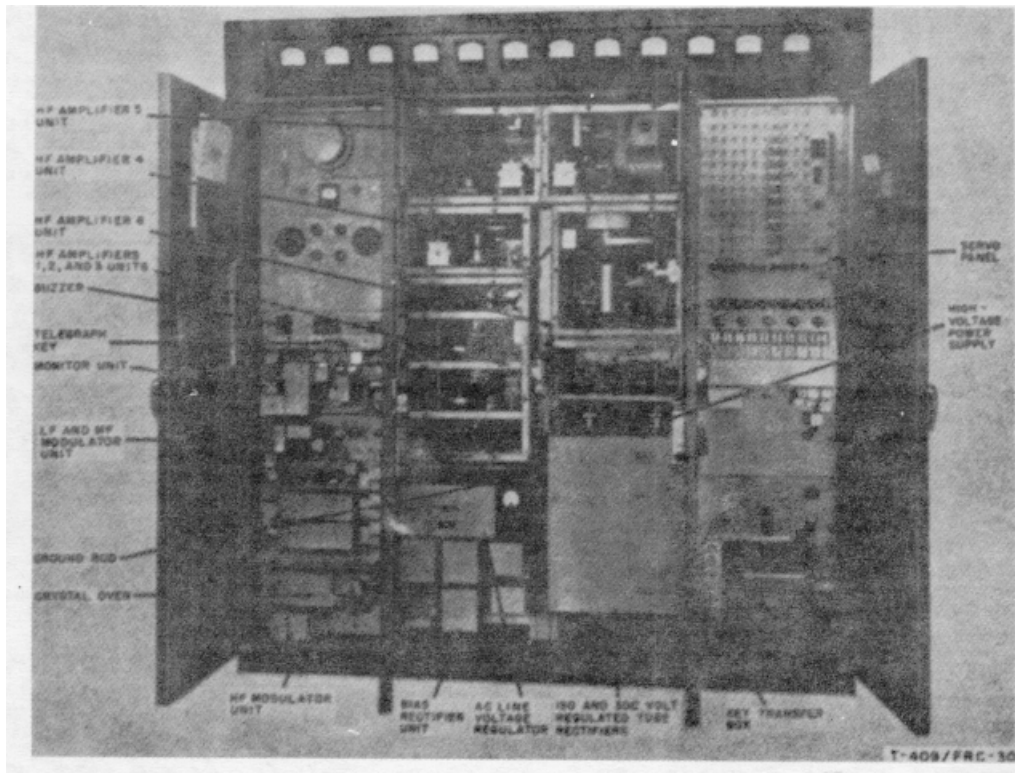

#### FUNCTIONAL DESCRIPTION:

Radio Transmitter T-409/FRC-30 is the transmitting component of the complete single-sideband Radio Set AN/FRC-30. It is an am, ssb, twin-channel, suppressed-carrier transmitter designed for long-range point-to-point communication, and operates in the frequency range of 4.5 to 28 mc. It also can be arranged to transmit conventional double sideband signals.

This equipment is an improved version of Radio Transmitter T-265/FRC-10, and is similar in appearance to that equipment. The major operational difference between the two transmitters is the frequency range covered.

#### RELATIONSHIP TO SIMILAR EQUIPMENT:

None.

#### TECHNICAL DESCRIPTION:

*Frequency Range in mc:* 4.5 to 28.0.

*Type Modulation:* Amplitude, ssb or dsb.

**RADIO TRANSMITTER**

**AN/FRT-type  
T-409/FRC-30**

*Power Output:*

Single Sideband Envelope: 4 kw.  
Double Sideband Carrier: 1 kw.

*Spurious signal Suppression:* 43 db below envelope pwr output.

*Tone volume:*

Speech Input Terminals: -13 to +20 dbm (+3 dbm normal).  
Test-Tone Input Terminals: 0 to +20 dbm (0 dbm normal).

*Vf Input Impedance:* 600 ohms.

*Frequency Accuracy:*

At 4 mc: +0.0011% or less.  
At 23 mc: ±0.0026% or less.

*Power Requirements:* 10 kw, 230 v 50/60-cy 3-pham ac; and 1 kw, 115 v 50/60-cy 1-phase ac auxiliary pwr.

*Major Unit:*

1	Generator	3 15/16" x 3 15/16" x 8"	
1	T-409/FRC-30	42 1/2" x 84" x 84"	5,800 lbs.

**TUBES, CRYSTALS, TRANSISTORS:**

None.

**REFERENCE DATA AND LITERATURE:**

TM 11-814.  
NAVSHIPS 92152.  
J41611AA-90.



**RADIO TELEPHONE TRANSMITTING EQUIPMENT**  
**AN/FRT-type**  
**TDD, TDD-1, -2, -3, -4**

5 December 1958  
 Cog. Serv.: USA FSN:  
 USA Line Item No:

	USA	USN	USAF	USMC
<b>STATUS OR TYPE CLASS.:</b>			L/Std TDD-4	

**Manufacturer:** TDD-2 and 3: Communications Co, Inc.  
 TDD-4: Starrett Television Corp.

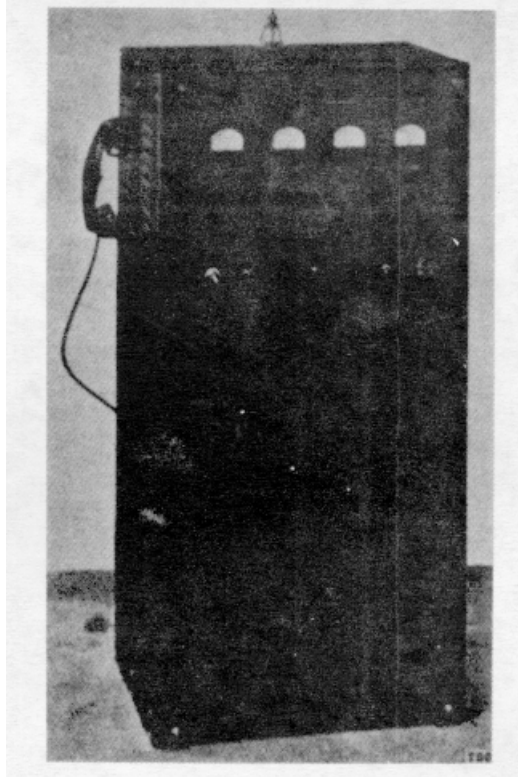

**FUNCTIONAL DESCRIPTION:**

Radio Telephone Transmitting Equipment TDD, TDD-1, -2, -3, and -4 are low-power transmitters for use in airport traffic control towers. They are crystal controlled and operate in the frequency range of 2:0 to 550 kilocycles. Provisions are made for connection of a remote telephone or microphone and a muting relay. The muting relay prevents feed-back or objectionable interference when a receiver is used in conjunction with the transmitter equipment. Models of the TDD series are electrically and mechanically interchangeable. Antenna (Crystals NT-40, 000) is required, but not supplied with the basic equipment.

**RELATIONSHIP TO SIMILAR EQUIPMENT:**

**TECHNICAL DESCRIPTION:**

*Frequency Range:* 200 to 550 kc in 3 bands.  
*Frequency Control:* Crystal  
*Type Emission:* A3.

**RADIO TELEPHONE TRANSMITTING EQUIPMENT****AN/FRT-type****TDD, TDD-1, -2, -3, -4**

*Amplitude Modulation:* 100%.

*Power Output:* 15 w average.

*Power Requirements:* 330 w; 115-v  $\pm 10\%$ , 60-cy, 1-phase ac.

*Antenna Type:* Single-wire, 100 to 500 ft.

*Major Units:*

Cabinet	TDD or TDD-1	18" x 25 1/2" x 52"	120 lbs.
NT-52258		14" x 14" x 9"	70 lbs.
Cabinet	TDD-2	18" x 25 1/2" x 52"	120 lbs.
NT-52258A		14" x 14" x 19"	70 lbs.
Cabinet	TDD-3	18" x 25 1/2" x 52"	120 lbs.
NT-52258B		14" x 14" x 19"	70 lbs.
NT-52258-C	TDD-4	17 5/8" x 22" x 51 3/4"	190 lbs.

**TUBES, CRYSTALS, TRANSISTORS:****REFERENCE DATA AND LITERATURE:**

TDD-2: NAVSHIPS 900, 271-1B.

TDD-3: NAVSHIPS 900, 271-1B.

TDD-4: NAVSHIPS 91499.

MIL-R-15588.

RECORDER  
AN/FRT-type  
RD-41B/U

1 March 1964

Cog. Serv.: USA FSN: 5895-241-3507

USA Line Item No: 658790

	USA	USN	USAF	USMC
STATUS OR TYPE CLASS.:	Std A			

Manufacturer: Hogan Laboratories Inc.

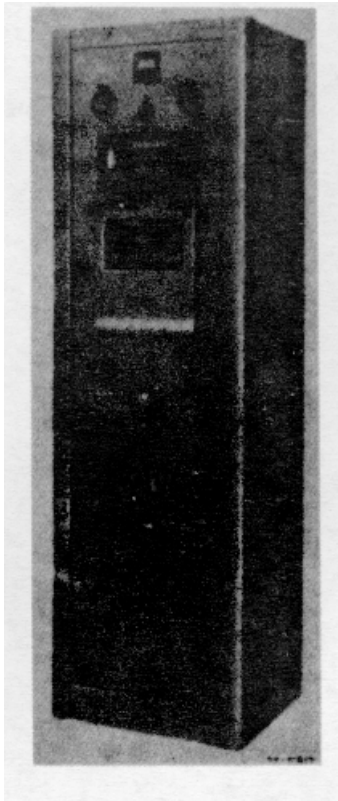

#### FUNCTIONAL DESCRIPTION:

Recorder RD-41B/U graphically records electrical signals or groups of signals of a definite cyclic or repetitive nature. An immediately visible, permanent record is made on a continuous strip which may be observed at the instant of recording or accumulated for subsequent visual analysis. The recorder is used to record at audio frequencies such signals as hand-keyed code, machine-keyed code, teletypewriter, facsimile signals, and oscillator outputs. Reception of signals may be from line or radio receiver. The scanning speed may be adjusted to synchronize with the signal recorded by varying the rpm of the drum. In special applications, recurring mechanical action may be converted to electrical values for recording. Recording is performed by electrically controlled deposits of metal upon a chemically treated paper.

#### RELATIONSHIP TO SIMILAR EQUIPMENT:

None.

#### TECHNICAL DESCRIPTION:

*Frequency Range:* 30 to 15, 000 cps.

**RECORDER****AN/FRT-type  
RD-41B/U***Recorded Line Length:* 8.2 in.*Paper Feed Rate:* 4.2, 8, 16, 70, 90, or 105 lines per in.*Drum Speed:* 45 to 400 rpm.*Width of Recording Paper:* 9 1/2 in.

Power Requirement: 715 w, 110/120 v 60-cy 1-phase ac.

*Major Units:*

1	Motor drive amplifier	8" x 14" x 19"	67 lbs.
1	Oscillator	6" x 8 3/4" x 19;"	25 lbs.
1	Power panel	4 3/8" x 8 3/4" x 19"	23 lbs.
1	Recorder	14 13/32" x 7 7/322" x 14 27/32"	29 lbs.
1	Recorder amplifier	10" x 8 3/4" x 19"	34 lbs.

**TUBES, CRYSTALS, TRANSISTORS:**

None.

**REFERENCE DATA AND LITERATURE:**

TM 11-5526.

TO 16-35RD41-5.

TELEPHONE SWITCHBOARD  
AN/FRT-type  
SB-53( )/FTC

1 March 1964

Cog. Serv.: USA FSN: 5805-164-7072

USA Line Item No: 678330

	USA	USN	USAF	USMC
STATUS OR TYPE CLASS.:	Std A		Std	

Manufacturer: Stromberg-Carlson Co Div - General Dynamics Corp.

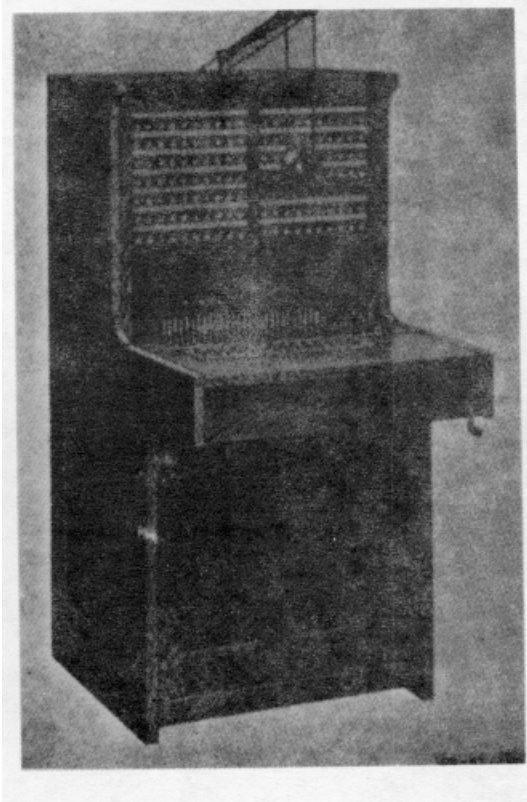

**FUNCTIONAL DESCRIPTION:**

Telephone Switchboard SB-53( )/FTC is a single-position, manual, cord-type, universal switch-board used to switch local common-battery and magneto lines, and for connecting other lines to trunk circuits. It is used in fixed-plant applications.

This equipment consists of a desk-type switchboard and uses a separate ringing generator, which is not furnished with the equipment. It is provided with a built-in magneto ringing generator for emergency use.

Fifteen simultaneous talking connections can be made through this equipment.

**RELATIONSHIP TO SIMILAR EQUIPMENT:**

None.

**TECHNICAL DESCRIPTION:**

*Number of Switchboard Positions: 1.*

*Number and Type of Circuits: 15 cord; 100 line; 10 trunk.*

**TELEPHONE SWITCHBOARD**

**AN/FRT-type**  
**SB-53( )/FTC**

*Power Requirements:* 24 v dc; separate ringing equipment supplies ringing current.

*Major Unit:* 1 SB-53( )/FTC 59" x 24" x 38 3/8" 550 lbs.

**TUBES, CRYSTALS, TRANSISTORS:**

None.

**REFERENCE DATA AND LITERATURE:**

TM 11-2087.  
(Mfr. No.) E-55486-FR.

**TELEPHONE SWITCHBOARD**  
AN/FRT-type  
SB-54/FTC

1 March 1964

Cog. Serv.: USA FSN: 5805-164-7071

USA Line Item No: 678335

	USA	USN	USAF	USMC
<b>STATUS OR TYPE CLASS.:</b>	Std A			

Manufacturer: Kellogg Switchboard &amp; Supply Co.

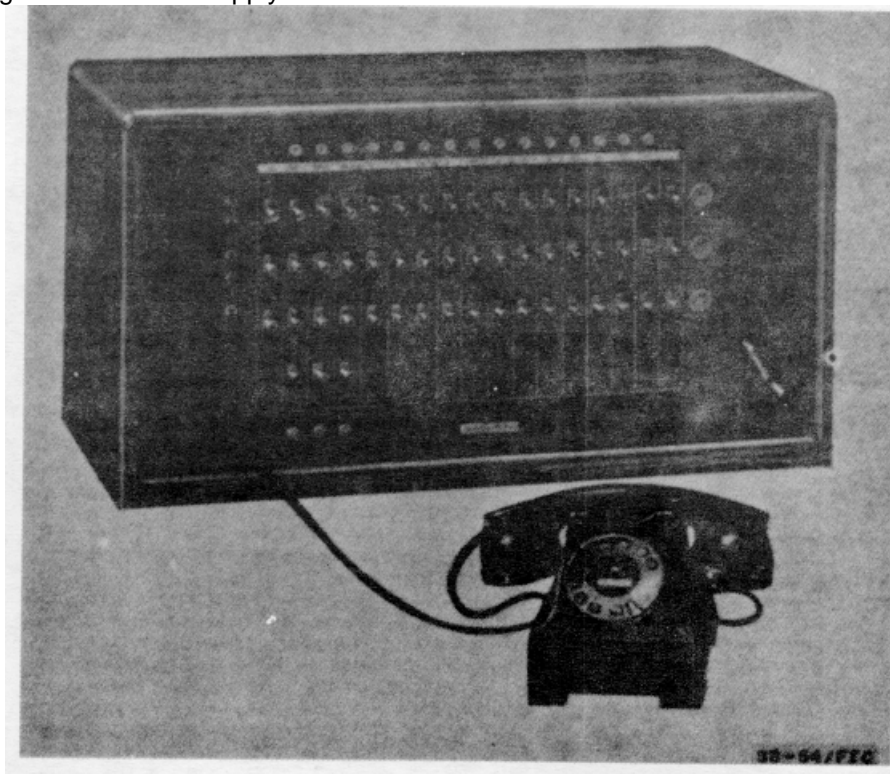
**FUNCTIONAL DESCRIPTION:**

Switchboard B-M54/FTC is a cordless, manual, single-position, common-battery telephone switch-board used for establishing connections between a small number of local stations or between such stations and a dial or manual central office. It is used in fixed-station applications.

This equipment consists essentially of a commercial (Kellogg 1007-cc special, or equal) telephone switchboard of the desk-mounted or turret type, in which interconnections are made by means of a key in each line or circuit. The maximum interconnection capacity is five telephone circuits or trunks.

It is designed for 48 v dc ringing from the central office, and has additional keys for night service. It includes provision for magneto ringing; and requires an operator's desk set, which is not furnished.

**RELATIONSHIP TO SIMILAR EQUIPMENT:**

None.

**TECHNICAL DESCRIPTION:***Number of Positions:* 1.*Number and Type of Circuits:* 5 connecting; 12 line; 5 trunk.

**TELEPHONE SWITCHBOARD**

**AN/FRT-type**  
**SB-54/FTC**

*Power Requirements:* Battery supplied by common-battery central office.

Major Unit: 1

SB-54/FTC

23" x 12" x 12" 110 lbs.

**TUBES, CRYSTALS, TRANSISTORS:**

None.

**REFERENCE DATA AND LITERATURE:**



TELEPHONE SWITCHBOARD  
AN/FRT-type  
SB-55( )/FTC

1 March 1964

Cog. Serv.: USA FSN: 5805-164-7086

USA Line Item No: 678370

	USA	USN	USAF	USMC
STATUS OR TYPE CLASS.:	Std A		Std	

Manufacturer: Kellogg Switchboard & Supply Co.

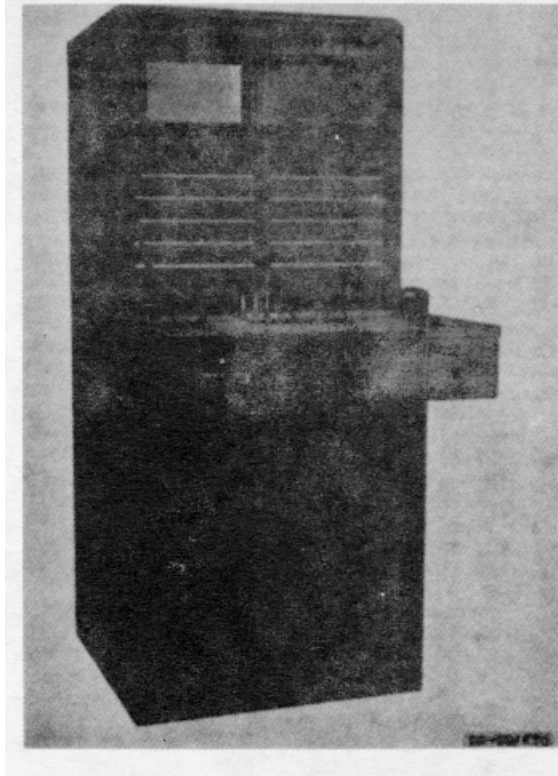

**FUNCTIONAL DESCRIPTION:**

Telephone Switchboard SB-55( )/FTC is a manual, single-position, two-panel switchboard used for fire-reporting and similar applications at fixed installations.

This equipment consists of a floor-type desk unit. The two trunks may be connected to either a dial or manual telephone facility.

It includes the operator's handset and other accessory items. Ringing current must be supplied by separate equipment.

**RELATIONSHIP TO SIMILAR EQUIPMENT:**

None

**TECHNICAL DESCRIPTION:**

*Number of Switchboard Positions:* 1.

*Number and Type of Circuits:* 3 cord; 100 line; 2 trunk

*Power Requirements:* 48 v dc

*Major Unit:* SB-55/FTC

38 1/4" x 24" x 57 1/4"

400 lbs.

**TELEPHONE SWITCHBOARD**  
**AN/FRT-type**  
**SB55( )/FTC**

**TUBES, CRYSTALS, TRANSISTORS:**

None.

**REFERENCE DATA AND LITERATURE:**

TM 11-2084.  
MIL-S-13171.

**SWITCHBOARD**  
**AN/FRT-type**  
**SB-56/FTC**

1 March 1964

Cog. Serv.: USA FSN:

USA Line Item No:

	USA	USN	USAF	USMC
<b>STATUS OR TYPE CLASS.:</b>	Std C			

**Manufacturer:** Kellogg Switchboard & Supply Co.

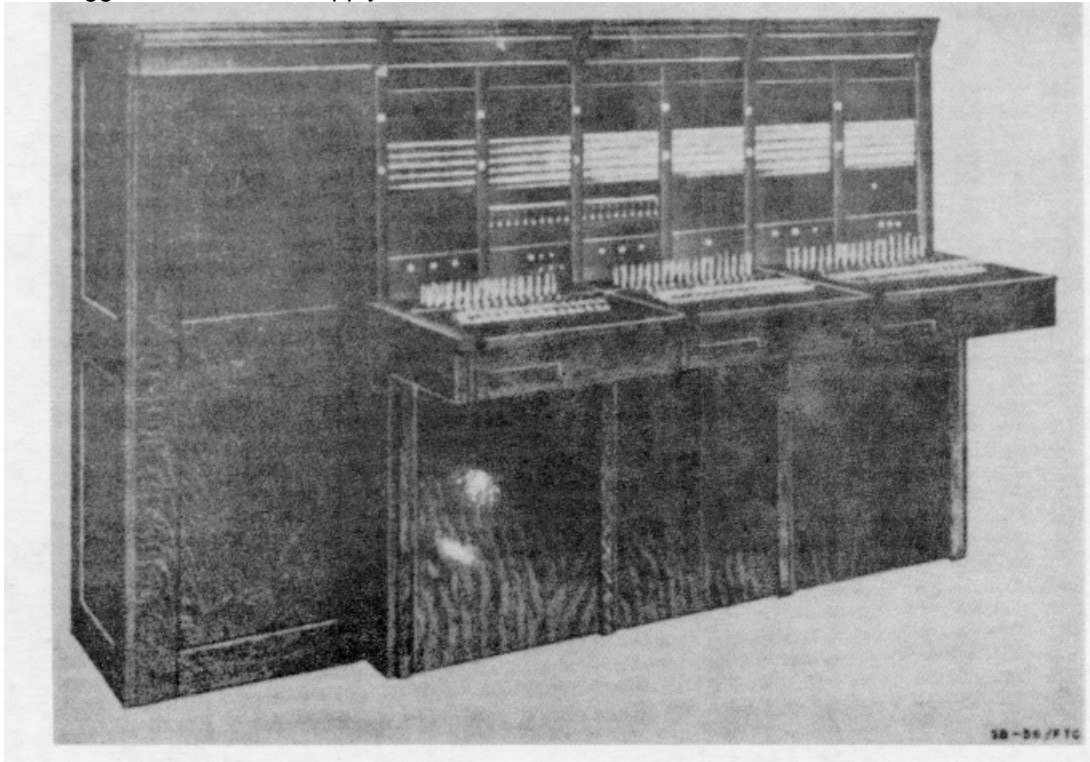

**FUNCTIONAL DESCRIPTION:**

Switchboard SB-56/FT'C is a three-position, multiple, common-battery, manual telephone switch-board with a maximum capacity of 800 lines.

his equipment consists of a commercial (Kellogg #6-800) central office type switchboard, each position of which has two jack panel sections. Each position has 15 universal cord circuits, a dial circuit, and an operator's circuit. The switchboard is wired and equipped for 20 magneto trunks, and 20 two-way trunks to automatic exchanges, lamp supervision, and miscellaneous circuits.

relay rack is mounted at the rear of the switchboard. The main distributing frame and operator's telephone equipment, are not supplied as part of this equipment; 24 volt battery supply and ringing current source must be separately procured.

**RELATIONSHIP TO SIMILAR EQUIPMENT:**

None.

**TECHNICAL DESCRIPTION:**

*Number of Positions:* 3 or more.

**SWITCHBOARD**

**AN/FRT-type  
SBS56/FTC**

*Number and Type of Circuits:* 45 cord (3 dial); 800 line; 40 trunk.

*Power Requirements:* 24 v dc.

*Major Units:* None.

**TUBES, CRYSTALS, TRANSISTORS:**

None.

**REFERENCE DATA AND LITERATURE:**

TM 11-2227.

**SWITCHBOARD  
AN/FRT-type  
SB-60/FTC**

1 March 1964

Cog. Serv.: USA FSN: 5805-162-8186

USA Line Item No:

	USA	USN	USAF	USMC
<b>STATUS OR TYPE CLASS.:</b>	Std C			

**Manufacturer:** Kellogg Switchboard & Supply Co.

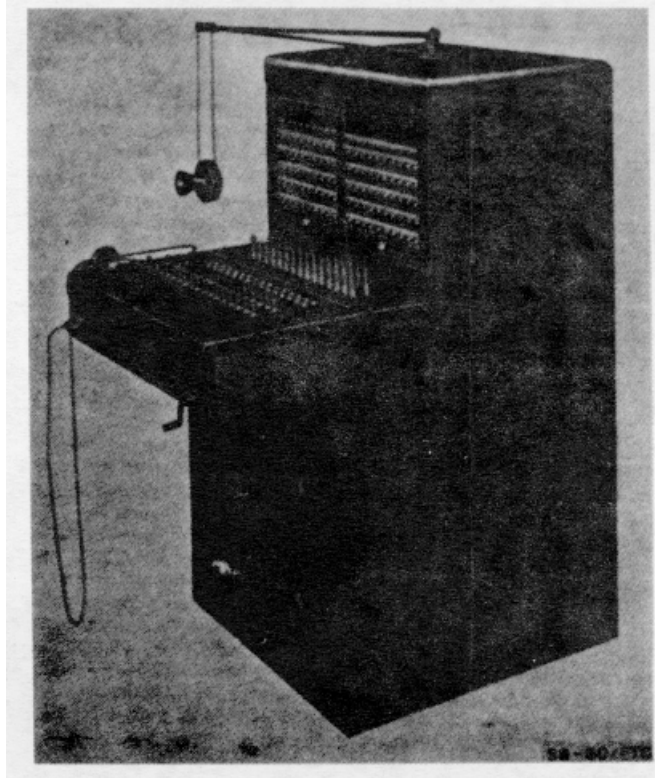

**FUNCTIONAL DESCRIPTION:**

Switchboard SB-60/TC is a single-position, nonmultiple, manual, magneto telephone switchboard used in situations where line resistance, leakage, or other unfavorable plant conditions prohibit satisfactory common battery operation.

This equipment is a floor-mounted, desk-type unit having combination drops (not shown in the illustration) and jacks arranged on two jack panels, and providing for 100 magneto lines, and 15 cords furnished and equipped for double drop supervision. There is also a five-bar hand generator wired to a key for switching to the power generator. An operator's telephone is included.

Local battery supply must be separately procured.

**RELATIONSHIP TO SIMILAR EQUIPMENT:**

None.

**TECHNICAL DESCRIPTION:**

*Number of Positions:* 1

*Number and Type of Circuits:* 15 cord; 100 line; 0 trunk.

**SWITCHBOARD**

**AN/FRT-type  
SB-60/FTD**

*Power Requirements: 3 v dc.  
Major Units: None.*

**TUBES, CRYSTALS, TRANSISTORS:**

None.

**REFERENCE DATA AND LITERATURE:**

**SWITCHBOARD**  
**AN/FTC-type**  
**SB-62/FTC**

1 March 1964

Cog. Serv.: USA FSN:

USA Line Item No:

	USA	USN	USAF	USMC
<b>STATUS OR TYPE CLASS.:</b>	Std C			

**Manufacturer:** Western Electric Co.

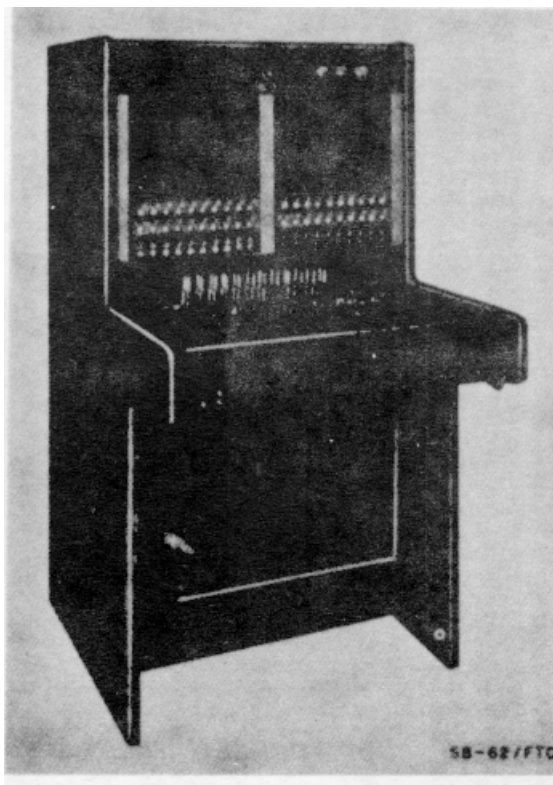

**FUNCTIONAL DESCRIPTION:**

Switchboard SB-62/FTC is a common-battery, nonmultiple, manual, telephone switchboard having circuits for dial (not shown in this illustration) or manual operation to connecting central offices. It is used in fixed plant applications.

This equipment consists essentially of a commercial (Western Electric Co No. 551A) telephone switchboard and is a floor-mounted desk-type unit. It is a single-position equipment with two panels and is wired for 40 common-battery lines, 10 cord circuits, and 10 trunks. It has lamp signaling and supervision, a hand generator for emergency signaling, an operator's telephone set, and includes 20 line-circuits equipped with relays for use on circuits of high line-resistance.

It does not include battery supply or ringing equipment.

**RELATIONSHIP TO SIMILAR EQUIPMENT:**

None.

**SWITCHBOARD**

**AN/FTC-type**  
**S-62/FTC**

**TECHNICAL DESCRIPTION:**

*Number of Positions:* 1.

*Number and Type of Circuits:* 10 cord, 40 line, 10 trunk.

*Major Unit:* 1 SB-62/FTC

25 1/2" x 30 1/2" x 46"

500 lbs.

**TUBES, CRYSTALS, TRANSISTORS:**

None.

**REFERENCE DATA AND LITERATURE:**



**SWITCHBOARD**  
**AN/FTC-type**  
**SB-63/FTC**

1 March 1964

Cog. Serv.: USA FSN: 5805-162-8187

USA Line Item No:

	USA	USN	USAF	USMC
<b>STATUS OR TYPE CLASS.:</b>	Std C			

**Manufacturer:** Kellogg Switchboard & Supply Co.

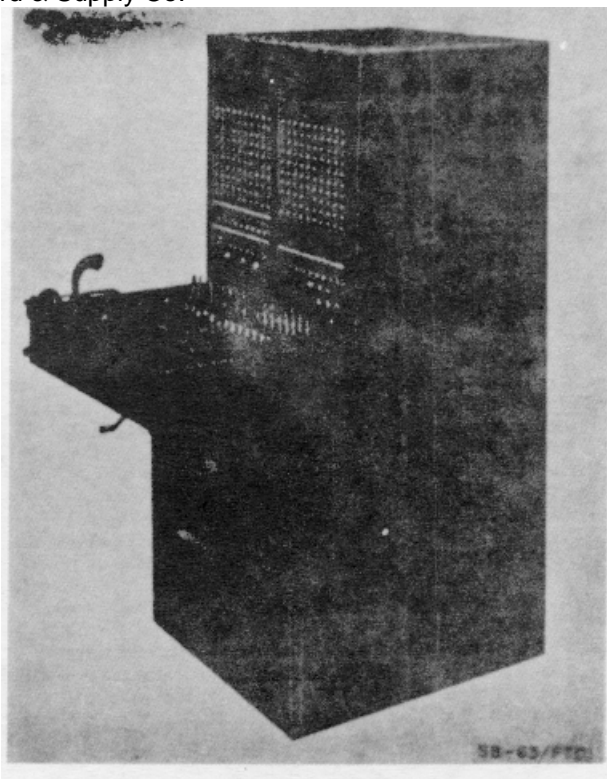

**FUNCTIONAL DESCRIPTION:**

Switchboard SB43/FTC is a single-position, manual, common-battery telephone switchboard used in fixed-plant applications.

This equipment consists essentially of a commercial (Kellogg Jr. Masterbuilt) telephone switchboard of the floor-mounted desk type. It has two jack panels and is equipped for 40 common-battery, 40 universal and 20 magneto (with lamp signaling) lines, and is wired for 20 (equipped for 10) dial trunks. It has 15 universal cord circuits, a hand generator for emergency ringing, and an operator's telephone set.

Ringing current and battery must be furnished separately.

**RELATION TO SIMILAR EQUIPMENT:**

**TECHNICAL DESCRIPTION:**

*Number of Positions:* 1.

*Number and Type of Circuits:* 15 cord; 40 common-battery line; 40 universal line; 20 magneto line; 10 trunk.

**SWITCHBOARD**

**AN/FTC-type**  
**SB-63/FTC**

*Power Requirement: 24v dc.*  
*Major Unit.: SB-63/FTC*

38 1/4" x 23 15/16" x 58 5/16"      500 lbs.

**TUBES, CRYSTALS, TRANSISTORS:**

**REFERENCE DATA AND LITERATURE:**

**SWITCHBOARD**  
**AN/FTC-type**  
**SB-64/FTC**

1 March 1964

Cog. Serv.: USA FSN: 5805-164-7074

USA Line Item No:

	USA	USN	USAF	USMC
<b>STATUS OR TYPE CLASS.:</b>	Std C			

**Manufacturer:** Western Electric Co.

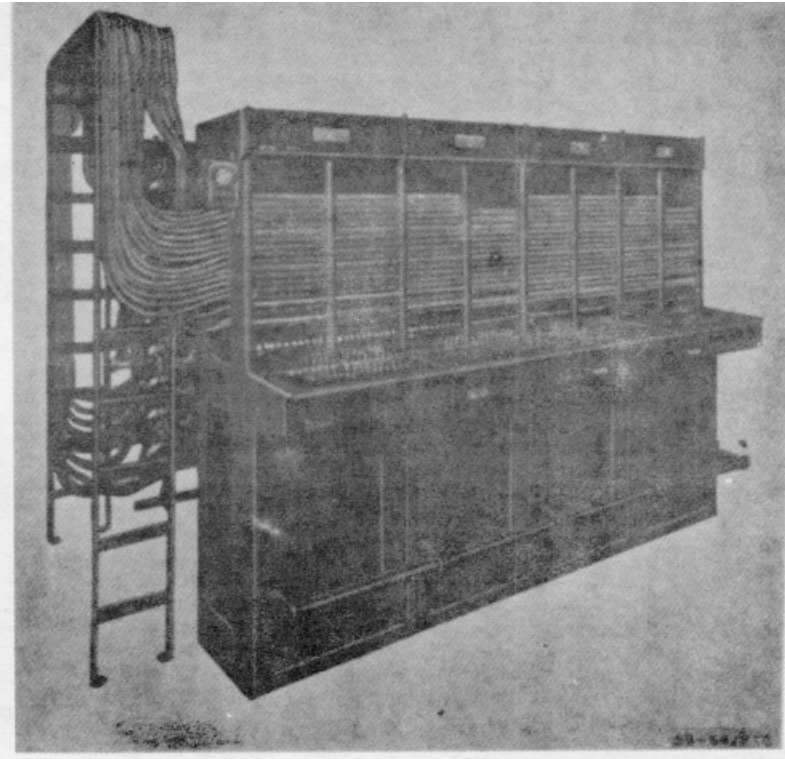

**FUNCTIONAL DESCRIPTION:**

Switchboard SB-64/FC is a medium-size central-office type, multiposition, manual, 640-line (maximum capacity) switchboard equipment used in fixed plant applications.

This equipment consists essentially of a commercial (Western Electric Co. No. 12,640-line) exchange switchboard, which is a four-position equipment constructed sectionally and having two jack panels per position, each position constituting a self-contained unit. It may be equipped with a total of 640 common battery and/or magneto lines with lamp signaling multiplied on a 2-panel basis, and 120 2-way ring-down trunks. Fifteen universal cord circuits are wired per position (the normal equipment for each position is 13 cords) with lamp supervisory equipment on cord circuits.

It also is equipped with dial and dial cord. Ringing current is supplied by a separate power unit. It uses a main distributing frame supplied separately, which is connected to this switchboard by cabling.

**RELATION TO SIMILAR EQUIPMENT:**

**SWITCHBOARD**

**AN/FTC-type**  
**SB-64/FTC**

**TECHNICAL DESCRIPTION:**

*Number of Positions:*

Maximum: As required.

Minimum: 3.

*Number and Types of Circuits Per Position:* 15 cord; 640 line; 120 trunk.

*Power Requirements:* 48-v dc.

*Major Unit:* 1

SB-64/FTC

3,360 lbs.

**TUBES, CRYSTALS, TRANSISTORS:**

**REFERENCE DATA AND LITERATURE:**

**MANUAL TELEPHONE SWITCHBOARD SECTION**  
**AN/FTC-type**  
**SB-171/FTC**

1 March 1964

Cog. Serv.: USA FSN: 5805-498-7752

USA Line Item No:

	USA	USN	USAF	USMC
<b>STATUS OR TYPE CLASS.:</b>	Std B			

Manufacturer: Kellogg Switchboard &amp; Supply Co.

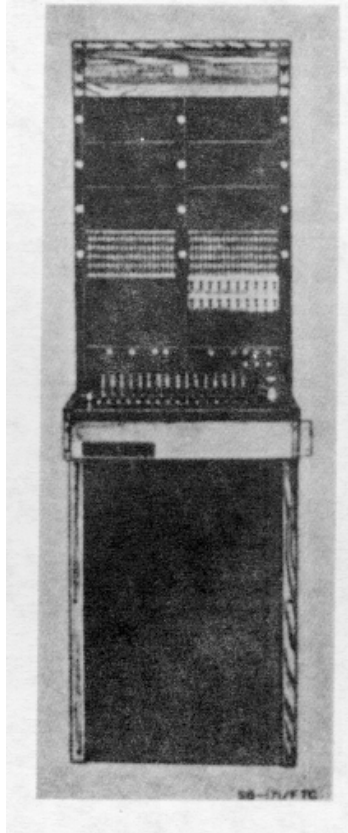
**FUNCTIONAL DESCRIPTION:**

Manual Telephone Switchboard Section SB-171/FTC is the basic unit of local manual central office switching facilities that are capable of handling 1,200 to 1,600 lines.

This equipment consists essentially of one commercial (Kellogg No. 1600) switchboard section equipped with 15 universal cord circuits.

The 1,200-line office (Coded Facility 152, TB SIG 322-152) includes 16 operating positions or sections and two end positions composed of the SB-171/FTC. The 1,600-line office (Coded Facility 156, TB SIG 322-156) has 22 such operating positions and two end positions.

**RELATION TO SIMILAR EQUIPMENT:****TECHNICAL CHARACTERISTICS:**

*Number of Switchboard Positions:* Depends on size of central office in which installed.

*Number and Type of Circuits:* 15 cord; trunk and line, as required.

*Major Unit:* 1 SB-171/FTC 22 5/8" x 37 1/16" x 72 7/8".

**MANUAL TELEPHONE SWITCHBOARD SECTION**

**AN/FTC-type  
SB-171/FTC**

**TUBES, CRYSTALS, TRANSISTORS:**

**REFERENCE DATA AND LITERATURE:**

TM 11-2061.

**TELEGRAPH-TELEPHONE SIGNAL CONVERTER**  
**AN/GCA-type**  
**TA-182/U**

1 March 1964

Cog. Serv.: USA FSN: 5805-356-2897

USA Line Item No: 611498

STATUS OR TYPE CLASS.:	USA	USN	USAF	USMC
	Std A			

Manufacturer: Kellogg Switchboard &amp; Supply Co.

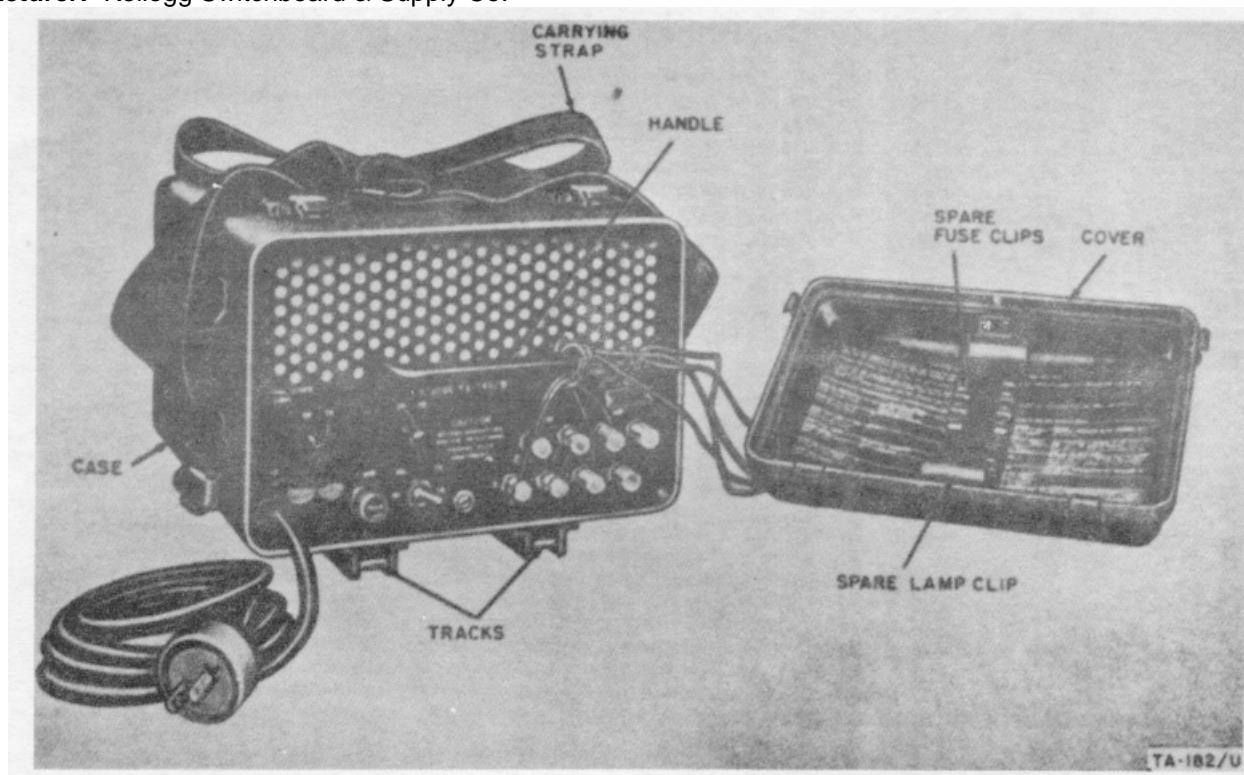
**FUNCTIONAL DESCRIPTION:**

Telegraph-Telephone Signal Converter TA-182/U provides a means of signaling in circuits that will not pass 20-cycle ringing signals because of line or equipment characteristics.

In telegraph circuits, it converts 20-cycle ringing signals to 1,225 cps for transmission, and reverses this operation upon reception. In telephone circuits, it converts 20-cycle ringing signals to 1,600 cps for transmission, and reverses this operation upon reception.

**RELATION TO SIMILAR EQUIPMENT:****TECHNICAL DESCRIPTION:**

*Type of Signal:* Ringing.

*Frequency:* Converts 20 cps to 1, 225 cps or 1, 600 cps.

*Type Communication Circuits:* Telegraph and telephone ringing.

*Controls:* 2-wire/4-wire selector switch; telephone-telegraph selector switch; high-low sensitivity selector switch.

**TELEGRAPH-TELEPHONE SIGNAL CONVERTER**

**AN/GCA-type  
TA-182/U**

*Power Requirements:* 40 w, 115-v ( $\pm 10\%$ ) 50/60-cy 1-phase ac.

*Major Unit:* 1 TA-182/U 11" x 7 1/2" x 10 1/2" 15 lbs.

**TUBES, CRYSTALS, TRANSISTORS:**

**REFERENCE DATA AND LITERATURE:**

M 11-2137.  
MIL-T-10267.



KEYER  
AN/GGA-type  
TG-10, TG-10-F

1 March 1964

Cog. Serv.: USA FSN: TG-10: 6940-407-3277  
TG-10-F: 5805-303-7753

USA Line Item No: 622060

	USA	USN	USAF	USMC
STATUS OR TYPE CLASS.:			L/Std	

Manufacturer: The Gray Manufacturing Co.

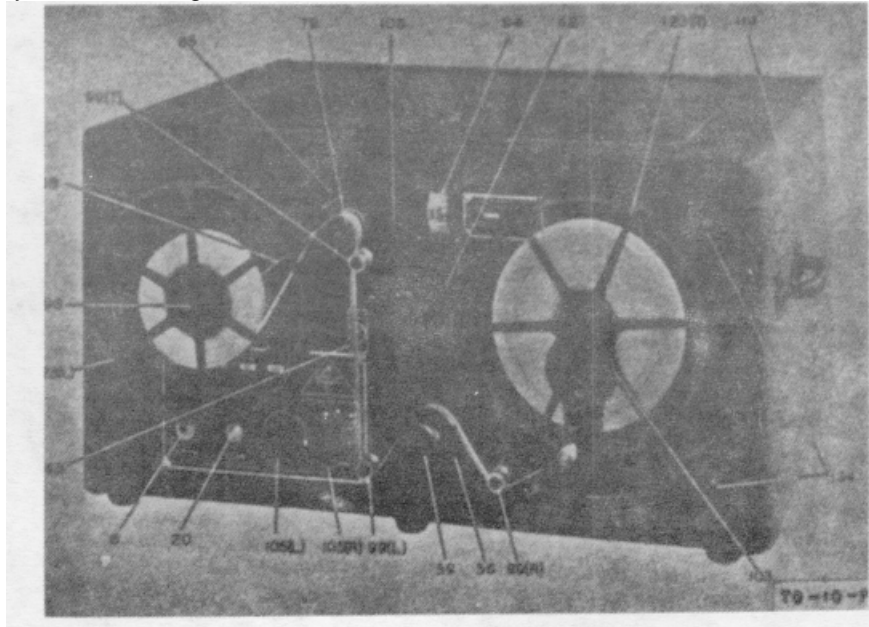

#### FUNCTIONAL DESCRIPTION:

Keyers TG-10 and TG-10-F are automatic keying units designed to provide audible code practice signals from an inked tape recording. The audio-frequency output of the keyer has sufficient power to supply as many as 500 to 1, 000 headsets, if necessary. Keyer tone may be supplied directly to headsets or to headsets through practice tables.

The keying unit may be operated with an external telegraph key. It also may be used as a tape puller for any one of several types of ink recorders where the recorder is not provided with its own tape-pulling mechanism.

The keyer is a self-contained unit. It is ready for operation when it is connected to an adequate power source and to the headsets or practice tables. The unit may be operated in its own case or removed and mounted on a standard 19-inch relay rack.

#### RELATION TO SIMILAR EQUIPMENT:

#### TECHNICAL DESCRIPTION:

*Speed:* 0 to 1, 000 wpm.

*Tone Frequency:* 800 cps.

*Power Source Requirements:* 115-V 50-cy 1-phase ac.

**KEYER**

**AN/GGA-type  
T-10, TG-10-F**

*Major Units:*

1	TG-10 or TG-10-F cased:	11" x 18 1/2" x 24"	63 lbs.
	Rack mounted:	8 3/4" x 19"	40 lbs.

**TUBES, CRYSTALS, TRANSISTORS:**

**REFERENCE DATA AND LITERATURE:**

TM 11-447.

TELETYPEWRITER SET  
AN/GGC-3

1 March 1964

Cog. Serv.: USA FSN: 5815-503-3309

USA Line Item No: 680720

	USA	USN	USAF	USMC
STATUS OR TYPE CLASS.:	Std A		Std	

Manufacturer: Kleinschmidt Laboratories, Inc.

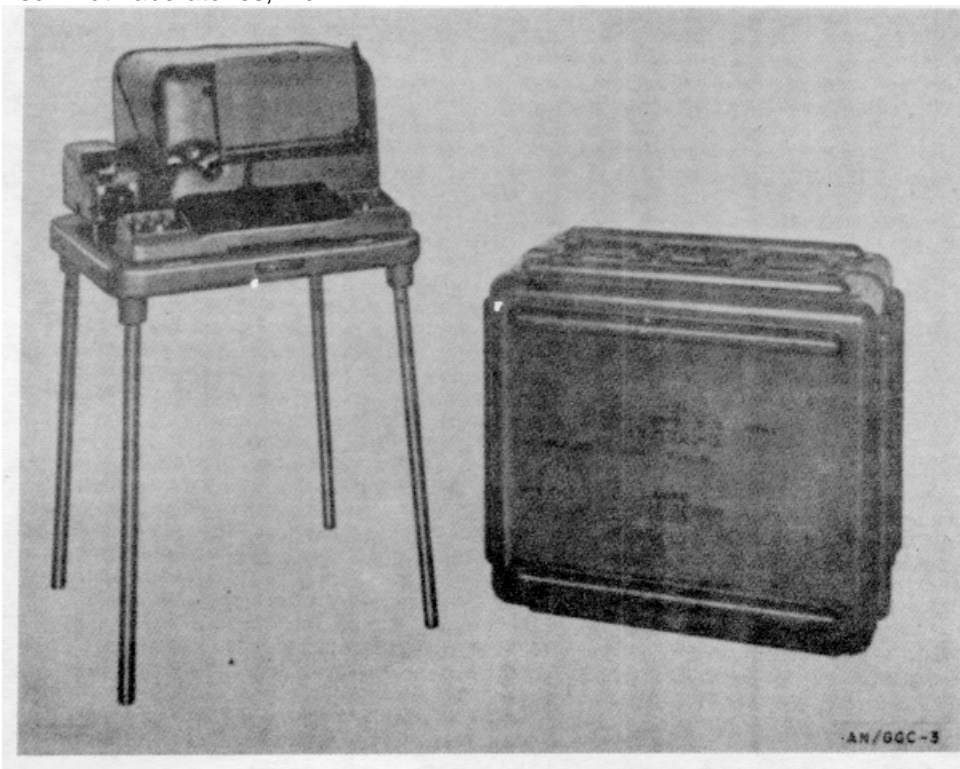
**FUNCTIONAL DESCRIPTION:**

Teletypewriter Set AN/GGC-3 is a lightweight, portable, sending and receiving equipment.

This equipment consists essentially of a typing reperforator unit with a keyboard transmitter, a tape transmitter and a teletypewriter table. It derives line-operating current from an associated teletypewriter switchboard, Telegraph Terminal TH-5/TG, or other external source, and can be arranged to operate on either neutral or polar signals on a half- or full-duplex basis.

This set provides facilities for sending from either a keyboard or a tape transmitter; received signals are printed and perforated on tape. It operates over de wire lines, carrier, or radio channels through suitable line terminating equipment, and is equipped with a universal series-governed motor, enabling operation from either ac or dc sources.

**RELATION TO SIMILAR EQUIPMENT:****TECHNICAL DESCRIPTION:**

*Operating Speed:* 368.1 or 600 opm.

*Motor Characteristics:* Universal ac or dc, series type.

**TELETYPEWRITER SET  
AN/GGC-3**

*Power Requirements:* 150 w, 115/230-v 50/60-cy 1-phase ac; or 115-v dc.

*Major Units:*

1	TT-76/GGC	21" x 18" x 12"	45 lbs.
1	CY-1110/GGC	25" x 22" x 16"	30 lbs.
1	FN-52/GGC	21" x 18" x 28"	15 lbs.

**TUBES, CRYSTALS, TRANSISTORS:**

**REFERENCE DATA AND LITERATURE:**

TM 11-2225.  
MIL-R-11177A.

TELEGRAPH SWITCHBOARD  
AN/GGC-type  
SB-6( )/GG

1 March 1964

Cog. Serv.: USA FSN: 5805-498-7459

USA Line Item No: 676430

	USA	USN	USAF	USMC
STATUS OR TYPE CLASS.:	Std A		L/Std	

Manufacturer: Artisan Electronics Corp.



**FUNCTIONAL DESCRIPTION:**

Telegraph Switchboard SB4( )/GG is a transportable, jack-patching manual switchboard used for interconnecting local lines, dc loops, extensions, and teletypewriter sets.

The equipment consists of 16 panel mounted jacks in a steel cabinet, and serves four line circuits. For each line circuit, there are two loop jacks, a set jack for connection of a teletypewriter or other equipment, and a miscellaneous jack for connection of auxiliary equipment or spare teletypewriter sets.

The equipment is used to switch circuits and to make tests of associated line facilities.

**RELATION TO SIMILAR EQUIPMENT:**

**TELEGRAPH SWITCHBOARD**

**AN/GGC-type**

**SB-6( )/GG**

**TECHNICAL DESCRIPTION:**

*Number of Position:* 1.

*Number and Type of Circuit:* 4 line.

*Major Unit:* 1 SB-6/GG

7 5/16" x 4 3/4" x 4 5/8"

4 lbs.

**TUBES, CRYSTALS, TRANSISTORS:**

**REFERENCE DATA AND LITERATURE:**

TM 11-2035.

MIL-S-3723.

AF AMPLIFIER  
AN/GIA-type  
AM-65/GRC

1 March 1964

Cog. Serv.: USA FSN: 5820-194-8303

USA Line Item No: 602200

	USA	USN	USAF	USMC
STATUS OR TYPE CLASS.:	Std A	Used by	Std	

Manufacturer: Raytheon Manufacturing Co.

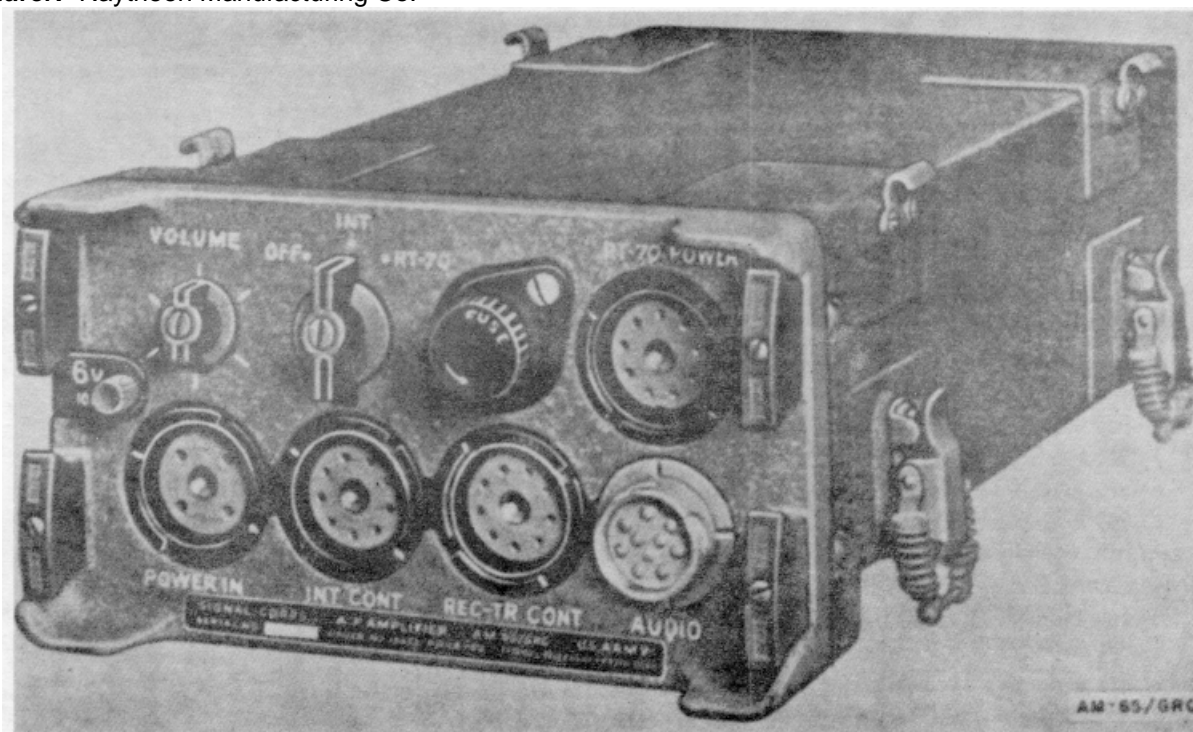

#### FUNCTIONAL DESCRIPTION:

AF Amplifier AM-65/GRC is a lightweight, compact, three-channel audio frequency amplifier and electronic mixer. It is designed to provide interphone operation and radio monitoring in vehicular installations which use one or two receiver-transmitters and one or more interphone control boxes.

The unit contains the audio amplifier and electronic mixer circuits necessary for amplifying and mixing signals from the receiver portions of one Receiver-Transmitter RT-70/GRC and one Receiver-Transmitter RT-66/GRC, RT-67/GRC, or RT-68/GRC, with the high level output of the self-contained interphone amplifier. Separate channels are provided in the amplifier for monitoring the output of the receivers of each type of receiving-transmitter while simultaneously monitoring the low-level output of the interphone amplifier.

Since the unit is intended primarily for vehicular operation, it contains all the power supply circuits required for operation from a 6-, 12-, or 24-volt vehicular battery system, in conjunction with a plug-in type vibrator unit-Power Supply PP-448/GR, PP-2/GRC, or PP-282/GRC respectively. The amplifier contains the power supply circuits required to

**AF AMPLIFIER****AN/GIA-type  
AM-65/GRC**

operate Receiver-Transmitter RT-70/GRC In addition, the unit acts as a junction box for all system connections of that receiver-transmitter.

AF Amplifier AM-65/GRC, combined with other installation components, may be used in the radio installations known as Radio Sets AN/GRC-3 through AN/GRC-8 and AN/VRC-7, -13, -14, or -15.

The following equipment is used with, but is not supplied with, AF Amplifier AM-65/GRC: Power Supply PP-448/GR and a 6-volt storage battery, PP-281/GRC and a 12-volt storage battery, or PP-282/GRC and a 24-volt storage battery. A separate 135-volt 8 supply and a 6-volt dc filament power source may be substituted for the vibrator power supply to operate the amplifier. In addition, Chest Set Group AN/GSA-6, Headset-Microphone H-63/U, Headset NT-49507, or Loudspeaker LS-166/U (for listening only) Microphone M-29/U (for talking only), are used as oscillating items.

**RELATION TO SIMILAR EQUIPMENT:****TECHNICAL DESCRIPTION:***Signal Input levels:*

Set 1+INPH CHAN: 5 v (max).

Set 2+INPH CHAN: 5 v (max).

Set 1+Set 2+INPH CHAN: 06 v (max).

*Signal Output Levels:*

Set 1 +INPH CHAN: 350 mw (min) with a 5 v Set 1 input signal

Set 1+Set 2+INPH CHAN: 800 mw (min) with 5 v Set 1 input in.

Set 2 +INPH CHAN: 350 mw (min) with a 5 v Set 2 input signal.

Set 1 +Set 2+INPH CHAN: 800 mw (min) with a 5 v Set 2 input.

Set 1 +INPH CHAN: 350 mw (min) with a 0.25-v interphone input signal.

Set 2+INPH CHAN: 350 mw (min) with a 0.25-v interphone input signal.

Set 1 +Set 2+INPH CHAN: 1,800 mw (min) with a 0.25-v interphone input signal.

*Input Impedances:*

Set 1+INPH CHAN: 1,600 ohm.

Set 2+INPH CHAN: 1,500 ohms.

Set 1+Set 2 INPH CHAN: 150 ohms.

*Output Impedance:* 600 ohms channels, tap for 150 ohms.

*Audio Frequency Response:* Flat to within 4 db for freq between 400 and 2, 500 cps, sharp cutoff beyond these limits.

*Distortion:* 10% (max) per channel.

*Cross Talk:* 50 db down (min) between Set 1+INPH CHAN and Set 2+INPH CHAN.

*Input Voltage Requirements for Operations with Vibrator Power Supply:*

PP48/GR: 6.1 amp at 6-v dc.

PP-281/GRC: 3.85 amp at 12-v de.

PP-282/GRC: 2.4 amp at 24-v de.

*Input Voltage Requirements for Operations with External Supply:*

Filaments, Relay, and Microphone: 6. 3-v dc.

Plates: 135-v dc.

*Voltages Made Available to Receiver-Transmitter RT-70/GRC:*

Plates: 78 ma at 90- to 95-v dc.

Filaments: 360 ma at 6.3 v.

Relay: 161 ma at 63 v.



**AF AMPLIFIER**

**AN/GIA-type  
AM-65/GRC**

*Operating Temperature Range:* -40° to +131° F.

*Power Requirements (Standby):*

Plates: 35 ma at 135-v dc.

Filaments: 1.2 amp at 6.3 v; 0.6 amp at 12.6 v.

Relay: 161 ma at 6.3 v.

Microphone: 30 ma at 6.3 v.

*Major Unit:* 1 AM-65/GRC

4 1/4" x 7 7/8" x 12 7/8"

15.5 lbs.

**TUBES, CRYSTALS, TRANSISTORS:**

**REFERENCE DATA AND LITERATURE:**

TM 11-5039.

CONTROL GROUP  
AN/GRA-6

1 March 1964

Cog. Serv.: USA FSN: 5820-537-3848

USA Line Item No: 611280

	USA	USN	USAF	USMC
STATUS OR TYPE CLASS.:	Std A			

Manufacturer: Federal Telephone Radio Co

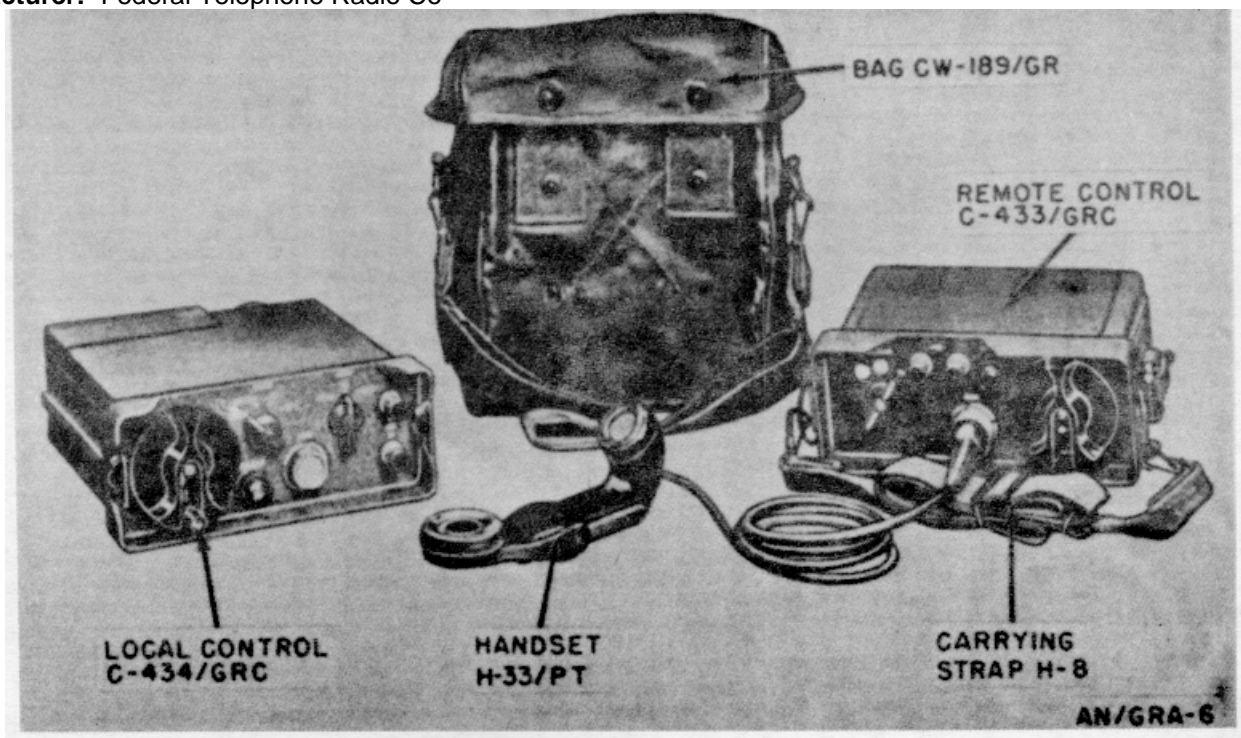
**FUNCTIONAL DESCRIPTION:**

Control Group AN/GRA-6 is a remote-control equipment used to operate one or two radio sets, either locally or from remote locations, and is used with radio communication equipment at battalion and regimental command levels.

This equipment consists of a remote-control unit, a local-control unit, and accessory components.

It enables push-to-talk control of radio equipment selected from either the local or remote point, and provides telephone facilities, including ringing or call lamp signaling, between operators up to distances of 2 miles over a conventional telephone pair.

**RELATION TO SIMILAR EQUIPMENT:****TECHNICAL DESCRIPTION:**

*Type of Signal:* Voice.

*Type Communication Circuits:* Duplex telephone communication; push-to-talk; power control.

**CONTROL GROUP****AN/GRA-6***Controls:*

On local control: LOCAL selector switch; REMOTE selector switch; and RINGER.

On remote control: SELECTOR switch and RINGER.

*Major Units:*

1	C434/GRC	3 1/2" x 10 1/8" x 8 9/16"	10.5 lbs.
1	C433/GRC	3 1/2" x 7 3/32" x 8 1/4"	7.0 lbs.

**TUBES, CRYSTALS, TRANSISTORS:****REFERENCE DATA AND LITERATURE:**

TM 11-5038.  
(USA)71-3329.

**RADIO SET CONTROL GROUP  
AN/GRA-11**

1 March 1964

Cog. Serv.: USA FSN: 5820-228-6108

USA Line Item No: 657135

	USA	USN	USAF	USMC
<b>STATUS OR TYPE CLASS.:</b>	Std B		Std	

Manufacturer: Air Communications, Inc.

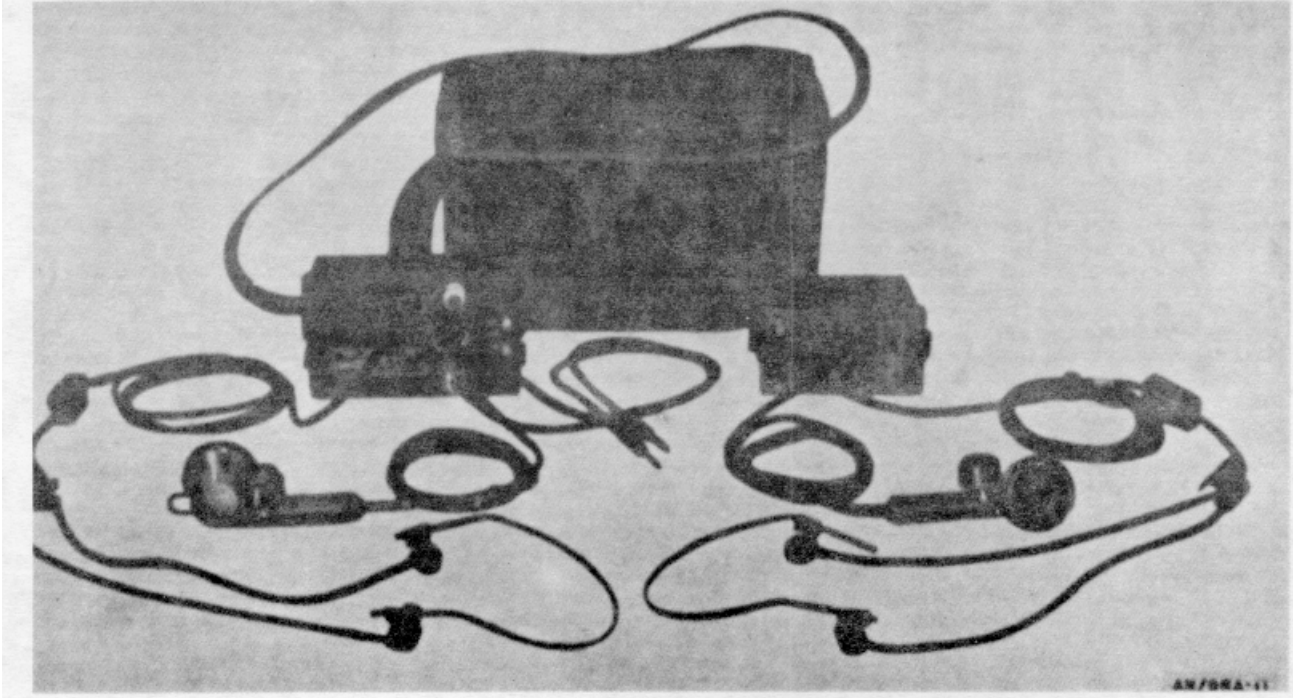

**FUNCTIONAL DESCRIPTION:**

Radio Set Control Group AN/GRA-11 is the joint nomenclature assigned to that equipment formerly known as Remote Control Equipment RC-261.

Radio Set Control Group AN/GRA-1 1 is an assemblage of items enabling the erection of a local battery telephone facility between a remote operating position and the actual site of a radio equipment. It is used in conjunction with radio equipment used at company and battery level in units organic to infantry, armored, and airborne divisions.

This equipment consists essentially of a control station designed to be operated at the remote point, a control box used at the radio set, and accessories. The remote control unit is connected to the control box at the radio set by a field wire pair.

By means of this equipment the radio set can be operated from the remote point. Transmission from the remote point can be monitored at the radio set, or operation at the radio set can be monitored at the remote point. In addition, the two terminal units of the system can be used as an intercommunication facility between the two locations.

The equipment is powered by dry batteries and by the hand generator unit that is integral in the remote control unit.

**RADIO SET CONTROL GROUP  
AN/GRA-11**

**RELATION TO SIMILAR EQUIPMENT:**

**TECHNICAL DESCRIPTION:**

*Type of Signal:* Cw and voice.

*Type Communication Circuits:* Local battery telephone.

*Controls:* One three-position switch marked RADIO, REMOTE, INTERPHONE; two-position impedance switch marked HIGH, LOW; and press-to-talk switch.

*Power Requirements:* 3-v dc (two Batteries BA-30); 6-v dc (four Batteries BA-30).

*Major Units:*

RM-53	8 1/2" x 4 3/8" x 4 3/8"	4.94 lbs.
RM-52	7 1/16" x 3 1/4" x 5 3/16"	3.5 lbs.

**TUBES, CRYSTALS, TRANSISTORS:**

**REFERENCE DATA AND LITERATURE:**

TM 11-2632.  
(USA)SC-D-7841, 7849.

**RADIO SET CONTROL GROUP  
AN/GRA-14**

1 March 1964

Cog. Serv.: USA FSN: 5820-503-1090

USA Line Item No: 657127

	USA	USN	USAF	USMC
<b>STATUS OR TYPE CLASS.:</b>	Std A		Std	

Manufacturer: George Vorow & Co.

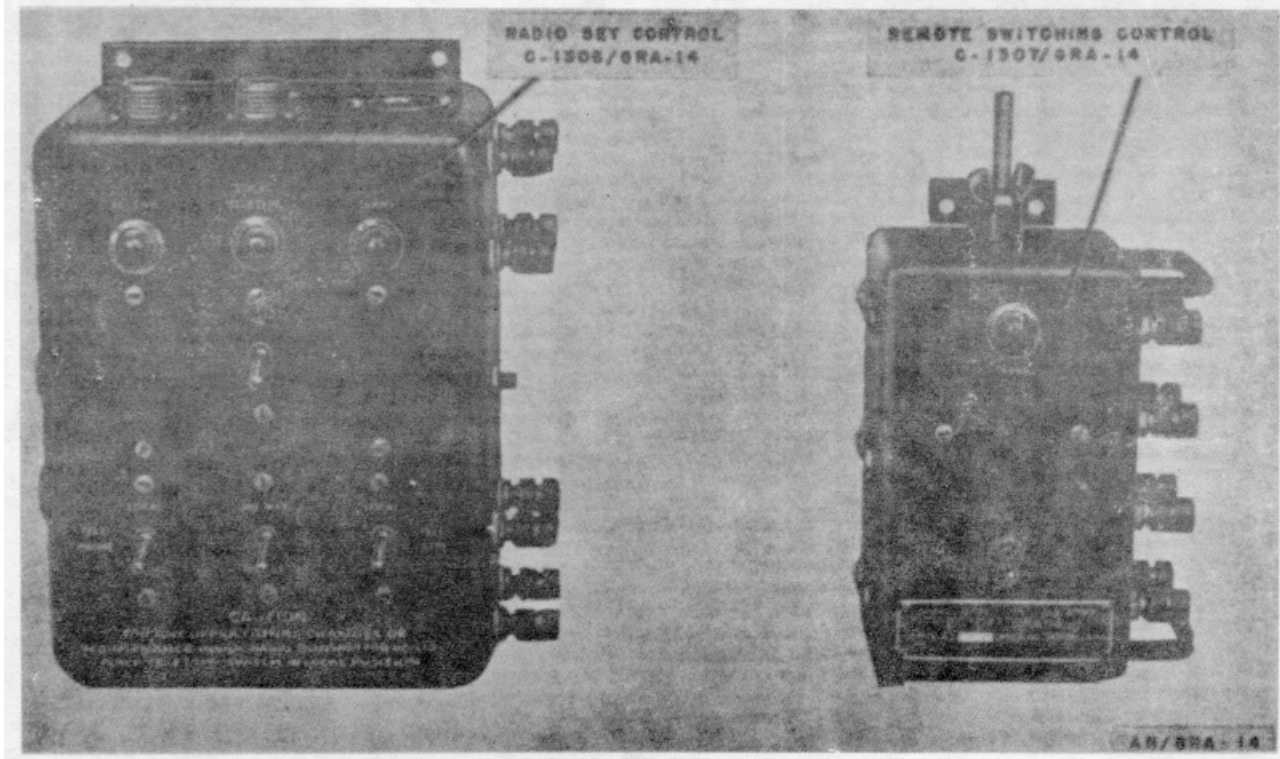

**FUNCTIONAL DESCRIPTION:**

Radio Set Control Group AN/GRA-14 is used with Radio Set AN/GRA-26A, AN/GRC-26B or AN/GRC-26C to provide remote control of the radio set over distances up to 1 mile. It enables control of the following functions of the radio set: switching from send to receive; radiotelephone or radioteletype communication on a one-way or full-duplex basis.

This radio set control group consists of a local-control unit, a remote-control unit, and six cables for connecting the local-control unit to the radio set. The local-control unit is mounted in the radio-set shelter and connected to the radio set and the local telephone. The remote-control unit is located at the remote site and is connected to the remote teletypewriter or telephone, and to a 115-volt ac power source.

The teletypewriters and the perforator transmitter may be moved from the radio-set shelter and located at the remote site. However, for full use of the radio set with the control group, two additional teletypewriters, a perforator transmitter or reperforator-transmitter teletypewriter, and a 115-volt ac power source are required.

**RELATION TO SIMILAR EQUIPMENT:**

**RADIO SET CONTROL GROW  
AN/GRA-14**

**TECHNICAL DESCRIPTION:**

*Types of Operation:* Switching from send to receive; radiotelephone and/or radioteletype communication on a one-way reversible or full-duplex basis; telephone communication to the radio-set shelter simultaneously with radioteletype communication to a distant station; teletypewriter communication to the radio-set shelter simultaneously with radiotelephone communication to a distant station.

*Controls:*

Local-control Unit: ON-OFF, TELEPHONE LOCAL-RADIO; ONE-WAY DUPLEX; LOCAL-RADIO TELETYPE.

Remote-control Unit: ON-OFF.

*Power Requirements:* 115-v ac (remote-control unit); 115-v dc (local control unit).

Major Units:

1	C-1306/GRA-14	12" x 4 3/4" x 8 1/2"	7.25 lbs.
1	C-1307/GRA-14	9 1/2" x 4" X 5 3/8"	3 lbs.

**TUBES, CRYSTALS, TRANSISTORS:**

**REFERENCE DATA AND LITERATURE:**

TM 11-264A.  
MIL-R-12665.

AMPLIFIER-MODULATOR GROUP  
AN/GRA-24

26 November 1958  
 Cog. Serv.: USA FSN:  
 USA Line Item No:

	USA	USN	USAF	USMC
STATUS OR TYPE CLASS.:			L/Std	

Manufacturer:

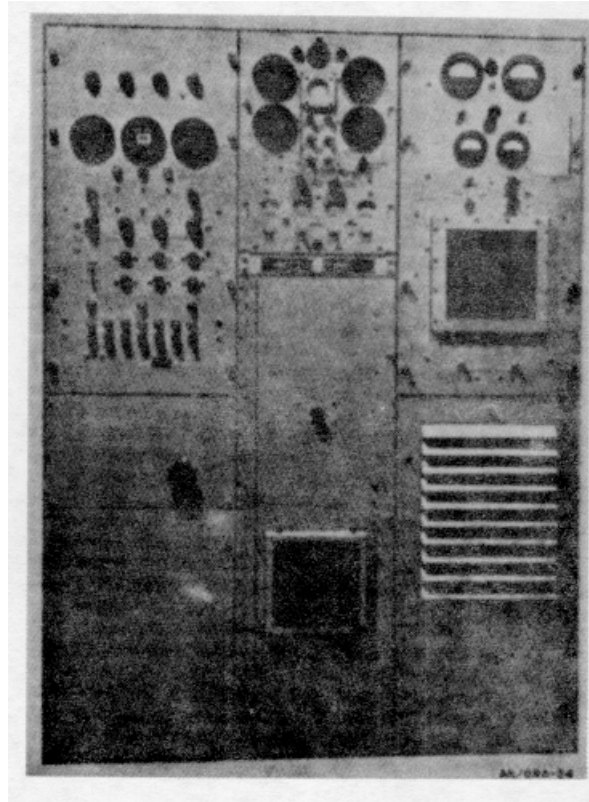

#### FUNCTIONAL DESCRIPTION:

Amplifier-Modulator Group AN/GRA-24 is an ultra-high-frequency power amplifier designed to increase the useful operating range of radio communication with aircraft. It requires an exciter input of 80 watts obtained from either Radio Set AN/GRC27 or Radio Transmitting Set AN/GRT-3.

This equipment is used where high power ground-to-air communication is required to provide more effective line-of-sight coverage.

The group is intended for single-channel, ground-to-air amplitude-modulated transmission of voice or digital data. It may be switched to either a directional or omnidirectional antenna by means of a switch on the control unit.

Antennas AS-450/GR, AS-505/GR, and AT-197/GR, not supplied, may be used with this equipment.

#### RELATIONSHIP TO SIMILAR EQUIPMENT:



**AMPLIFIER-MODULATOR GROUP  
AN/GRA-24**

**TECHNICAL DESCRIPTION:**

*Frequency in Mc:* 225 to 400.

*Type Modulation:* am, fm (F1, F9; by modification of drivers).

*Type Signal:* Tone, voice, composite transmission.

*Exciter Input:* 80 w.

*Power Output:* 1,000 w (min).

*Power Requirements:* 9 kva, 208-v ( $\pm 10$ -v) 50-60-cy 3-phase ac; 0.9 pf, 4-wire system.

*Major Units:*

1	Amplifier-modulator group	48" x 36" x 60"	1,825 lbs.
1	Control unit	19" x 20" x 8 3/4"	50 lbs.

**TUBES, CRYSTALS, TRANSISTORS:**

**REFERENCE DATA AND LITERATURE:**

MIL-A-9529.

ANTENNA  
AN/GRA-type  
AT-249/GRD

1 March 1964

Cog. Serv.: USA FSN: 5985-264-7493

USA Line Item No: 603110

	USA	USN	USAF	USMC
STATUS OR TYPE CLASS.:	Std C			

Manufacturer:

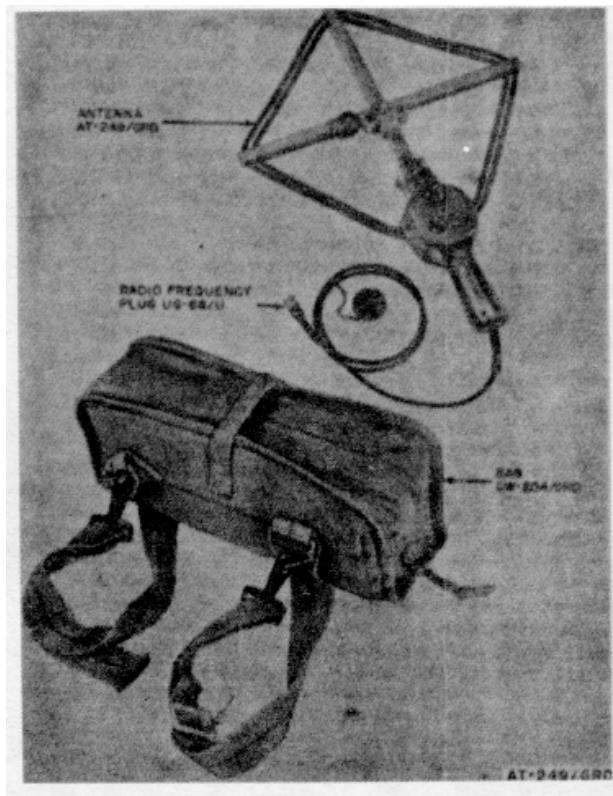

**FUNCTIONAL DESCRIPTION:**

Antenna AT-249/GRD, when connected to Radio Set AN/PRC-6, comprises an effective homing device that permits the radio operator to find the direction of a radio transmitter tuned to the frequency of the Radio Set AN/PRC-6 and to proceed toward it.

Highly accurate bearings generally are not required for homing; therefore, an azimuth scale is not provided. When desired, azimuth readings can be obtained by sighting a pocket compass in the direction of the indicated bearings.

Homing Antenna AT-339/PRC can be used in place of Antenna AT-249/GRD. The AT-249/GRD can be used, in the 47- to 55.4-mc range, with Radio Set AN/PRC-10, and with all radio sets containing Receiver-Transmitter RT-68/GRC or Radio Receiver R-110/GRC.

**RELATIONSHIP TO SIMILAR EQUIPMENT:**

**ANTENNA**

**AN/GRA-type**  
**AT-249/GRD**

**TECHNICAL DESCRIPTION:**

*Frequency Range:* 47 to 55.4 mc, continuously variable.

*Type:* Unshielded loop.

*Provision for Sensing:* Built-in SENSE or NORMAL switch.

*Output Control:* Four-position step attenuator.

*Major Unit:* 1      AT-249/GRD      3 1/2" x 14 5/8" x 20 1/4"      2 lbs.

**TUBES, CRYSTALS, TRANSISTORS:**

**REFERENCE DATA AND LITERATURE:**

TM 11-5058.

GENERATOR  
AN/GRA-type  
GN-58-A

1 March 1964

Cog. Serv.: USA FSN: 6115-330-9723

USA Line Item No: 618060

	USA	USN	USAF	USMC
STATUS OR TYPE CLASS.:	Std B			

Manufacturer:



#### FUNCTIONAL DESCRIPTION:

Generator GN-58-A is a hand operated generator unit designed to supply power to Receiver-Transmitter RT-77/GRC-9 when a vehicular battery is not available, as in portable field use. The equipment requires a single operator who sits astride the leg seat and rotates the generator cranks in the direction indicated on the generator housing.

The generator incorporates a plug-in voltage regulator that operates to keep the output voltage constant, regardless of the speed of rotation or the amount of load on the generator, within 50 to 70 rpm limits.

The GN-58-A is similar/to Generator GN-58 except for changes in component parts of voltage regulators and filters.

#### RELATIONSHIP TO SIMILAR EQUIPMENT:

None.

**GENERATOR**

**AN/GRA-type**  
**GN-58-A**

**TECHNICAL DESCRIPTION:**

*Speed of Rotation:* 50 to 70 rpm.

*Operation:* Manual, by hand crank.

*Regulation:* By varying field currents dependent upon speeds of rotation above 50 rpm.

*Power Output:* 115 ma at 425 v dc; 2.5 amp at 6.3 v dc.

*Major Unit:* 1 GN-58-A 7 1/2" x 8" x 10 1/2" 22.75 lbs.

**TUBES, CRYSTALS, TRANSISTORS:**

**REFERENCE DATA AND LITERATURE:**

TM 11-263 or TO 31R2-2GRC9-1.

RADIO SET  
AN/GRC-3

1 March 1964

Cog. Serv.: USA FSN: 5820-230-0453

USA Line Item No: 639200

	USA	USN	USAF	USMC
STATUS OR TYPE CLASS.:	Std B	Std		

Manufacturer:

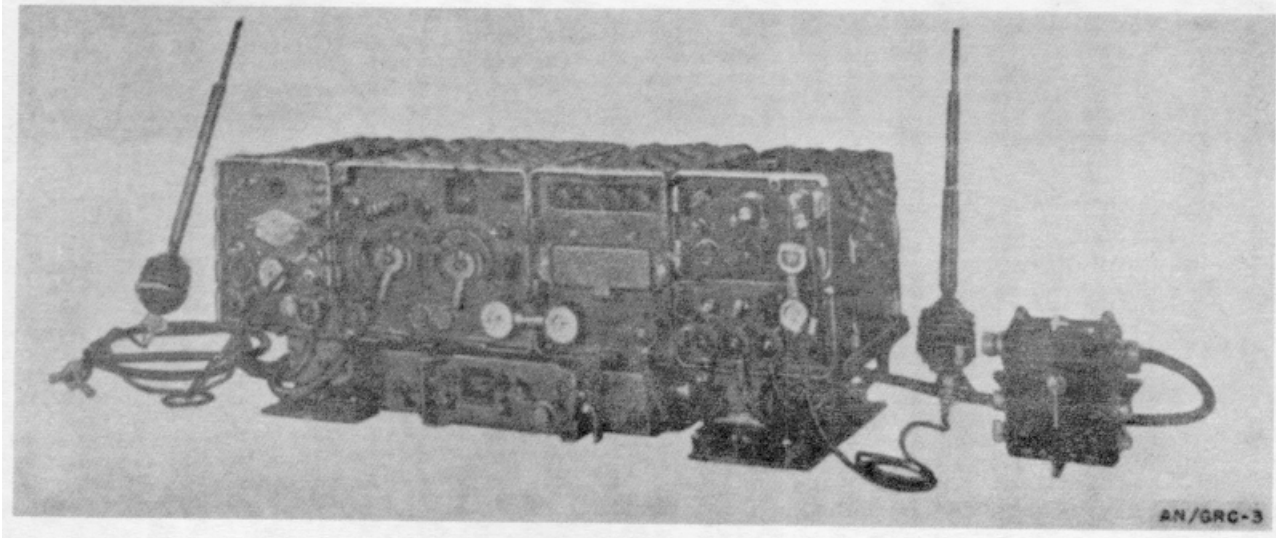
**FUNCTIONAL DESCRIPTION:**

Radio Set AN/GRC-3 is a short-range, fm (voice), two-way communication equipment having provision for retransmission, duplex, and remote control operation. It is one of the integrated series of radio equipment and is used by units organic to an armored division.

It consists of a medium-power radio receiver-transmitter component, designated as set 1, and an auxiliary radio receiver, both of which operate in the frequency range assigned to armored units. In addition, it includes a separate low-power, short-range receiver-transmitter, designated as set 2, which operates in a frequency band common to armored, artillery, and infantry units. Vehicular interphone amplifier and control units for selecting desired modes of operation and service are included.

It operates in a vehicle from the 12- or 24-v vehicular storage battery. A hand generator and associated components (Modification Kit MX-898/GR) provide for operation in semipermanent locations.

**RELATIONSHIP TO SIMILAR EQUIPMENT:****TECHNICAL DESCRIPTION:***Frequency Range in Mc:*

Receiver-Transmitter RT-66/GRC (set 1): 20.0 to 27.9.

Receiver-Transmitter RT-70/GRC (set 2): 47.0 to 58.4.

Radio Receiver R-108/GRC (auxiliary receiver): 20.0 to 27.9.

*Type Modulation:* fm.*Type of Signal:* Voice and 1,600-cy fm signals.

**RADIO SET****AN/GRC-3***Power Output:*

	<i>Transmitting</i>		
	<i>Low</i>		<i>High</i>
	1 to 2 w		9 to 16 w
Set 1:			
Set 2:		0.5 w	
		<i>Receiving</i>	
	<i>Phone</i>	<i>Speaker</i>	<i>Retransmission</i>
Set 1:	50 mw	1 w	30 mw
Set 2:			75 mw
Auxiliary receiver:	50 mw	1 w	30 mw

*Power Requirements:* 110 to 280 w (depending upon mode of operation) from 12/24-v vehicular storage battery.

*Major Unit:*

1	AM-65/GRC	4 1/4" x 13" X 7 7/8"	15.5 lbs.
1	C-435/GRC	3 1/2" x 10 1/2" x 8 3/4"	12 lbs.
1	PP-109/GRC, or	8" x 13" x 9"	33 lbs.
1	PP-112/GRC		
2	PP-281/GR, or	4 1/2" x 6" x 3"	6 lbs.
2	PP-282/GR		
1	R-108/GRC	9" x 13" x 7 1/4"	35 lbs.
1	RT-66/	9" x 13" X 11 1/4"	35 lbs.
1	RT-70/	4 3/4" x 13" x 7 1/8"	25 lbs.

**TUBES, CRYSTALS, TRANSISTORS:****REFERENCE DATA AND LITERATURE:**

TM 11-284.

RADIO SET  
AN/GRC-4( )

1 March 1964

Cog. Serv.: USA FSN: 5820-243-6418

USA Line Item No: 639300

	USA	USN	USAF	USMC
STATUS OR TYPE CLASS.:	Std B	Std		

## Manufacturer:

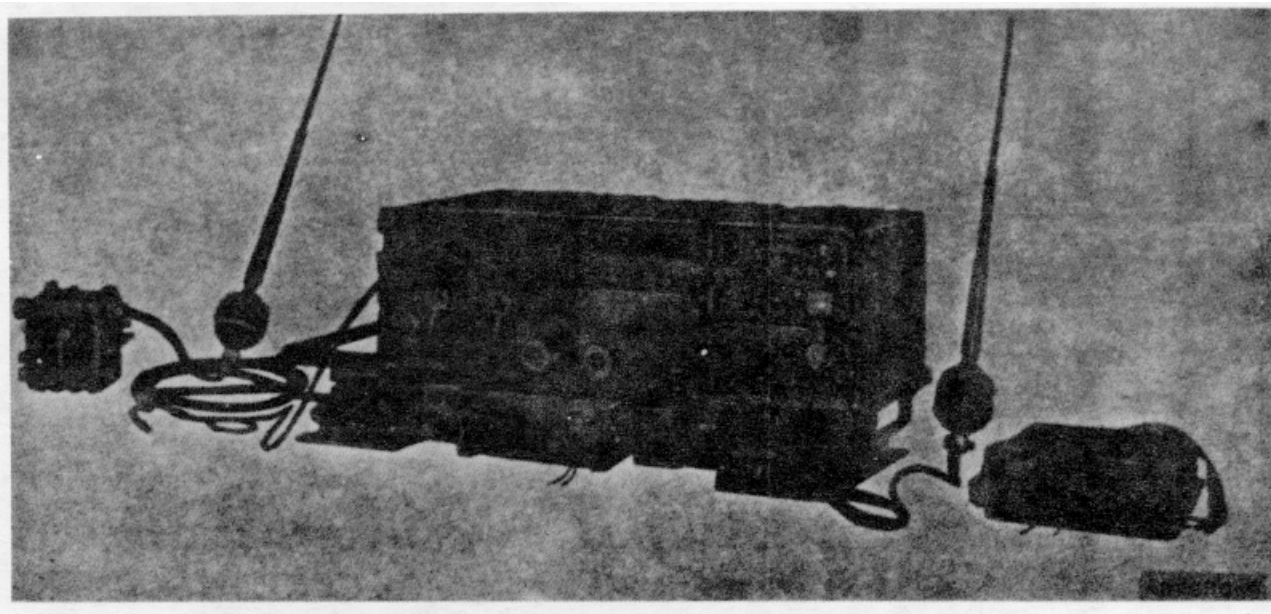

## FUNCTIONAL DESCRIPTION:

Radio Set AN/GRC4( ) is a short-range, fm (voice), two-way communication equipment having provision for retransmission, duplex, and remote control operation. It is one of the integrated series of radio equipment and is used by units organic to an armored division.

It consists of a medium-power radio receiver-transmitter component, designated as set 1, that operates in the frequency range assigned to armored units, and a low-power receiver-transmitter, designated as set 2, that operates in a frequency band common to armored, artillery, and infantry units. Vehicular interphone amplifier and control units for selecting desired modes of operation and service are included.

This equipment generally operates in a vehicle from the 12- or 24-v vehicular storage battery; hand generator and associated components (Modification Kit MX-898/GR) may be used for operation in semipermanent ground applications.

## RELATIONSHIP TO SIMILAR EQUIPMENT:

## TECHNICAL DESCRIPTION:

*Frequency Range in Mc:*

Receiver-Transmitter RT-6/GRC (set 1): 20.0 to 27.9.

Receiver-Transmitter RT-70/GRC (set 2): 47.0 to 58.4.

*Type Modulation:* fm.*Type of Signal:* Voice and 1,600-cy fm signals.



RADIO SET  
AN/GRC-4( )

*Power Output:*

		<i>Transmitting</i>		
		<i>Low</i>		<i>High</i>
Set 1:		1 to 2 w		9 to 16 w
Set 2:			0.5 w	
		<i>Receiving</i>		
		<i>Phone</i>	<i>Speaker</i>	<i>Retransmission</i>
Set 1:		50 mw	1 w	30 mw
Set 2:			75 mw	

*Power Requirements:* 110 to 280 w (depending upon mode of operation), 12/24 v dc from vehicular storage battery.

*Major Units:*

1	AM-4/GRC	4 1/4" x 13" x 7 7/8"	15.5 lbs.
1	C-435/GRC	3 1/2" x 10 1/2" x 8 3/4"	12.
1	PP-109/GR, or PP-112/GR	8" x 13" x 9"	33.
1	PP-281/GR, or PP-282/GR	4 1/2" x 6" x 3"	6.
1	RT-66/GRC	9" x 13" x 11 1/4"	35.
1	RT-70/GRC	4 3/4" x 13" x 7 1/8"	25.

**TUBES, CRYSTALS, TRANSISTORS:**

**REFERENCE DATA AND LITERATURE:**

TM 11-284

RADIO SET  
AN/GRC-5

1 March 1964

Cog. Serv.: USA FSN: AN/GRC-5: 5820-230-0449  
AN/GRC-5X: 5820-230-0460

USA Line Item No: 639400

	USA	USN	USAF	USMC
STATUS OR TYPE CLASS.:	Std B	Std		

Manufacturer:

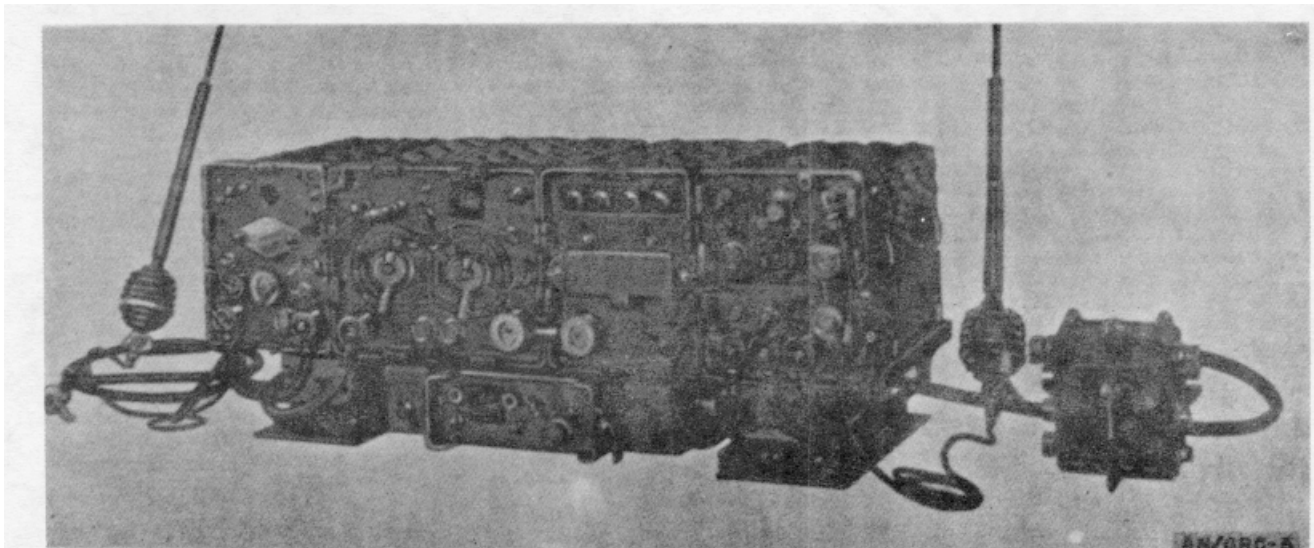
**FUNCTIONAL DESCRIPTION:**

Radio Set AN/GRC-5 is a short-range, fm (voice), two-way communication equipment having provision for retransmission, duplex, and remote control operation. It is one of the integrated series of radio equipment used by artillery units.

This equipment consists of a medium-power radio receiver-transmitter, designated as set 1, operating on frequencies assigned to field artillery and a low-power receiver-transmitter designated as set 2, operating on frequencies common to artillery, armored, and infantry units for communication and liaison among all three types of organizations. It includes an auxiliary receiver, a vehicular interphone amplifying equipment, and control units for selecting desired modes of operation and service.

It generally operates in a vehicle from the 12- or 24-v vehicular storage battery; a hand generator and associated components (Modification Kit MX-98/GR) may be used for semipermanent field operation of set 1 or set 2 removed from the vehicle.

**RELATIONSHIP TO SIMILAR EQUIPMENT:****TECHNICAL DESCRIPTION:***Frequency Range in Mc:*

Receiver Transmitter RT-67/GRC (set 1): 27.0 to 38.9.

Receiver-Transmitter RT-70/GRC (set 2): 47.0 to 58.4.

Radio Receiver R-109/GRC (auxiliary receiver): 27.0 to 38.9.

*Type Modulation:* fm.*Type of Signal:* Voice and 1,600-cy fm tone signals.

**RADIO SET  
AN/GRC-5**

*Power Output:*

	<i>Transmitting</i>		
	<i>Low</i>		<i>High</i>
Set 1:	1 to 2 w		9 to 16 w.
Set 2:		0.5 w	
	<i>Receiving</i>		
	<i>Phone</i>	<i>Speaker</i>	<i>Retransmission</i>
Set 1:	50 mw	1 w	30 mw.
Set 2:			75 mw
Auxiliary receiver:	50 mw	1 w	30 mw.

*Power Requirements:* 110 to 280 w (depending upon mode of operation) from 12/24-v vehicular storage battery.

*Major Units:*

1	AM-65/GRC	4 1/4" x 13" x 7 7/8"	15.5 lbs.
1	C-435/GRC	3 1/2" x 10 1/2" x 8 3/4"	12.
1	PP-109/GR or PP-112/GR	8" x 13" x 9"	33.
2	PP-281/GR or PP-282/GR	4 1/2" x 6" x 3"	6.
1	R-109/GRC	9" x 13" x 7 1/4"	35.
1	RT-67/ORC	9" x 13" x 11 1/4"	35.
1	RT-70/ORC	4 3/4" x 13" x 7 1/8"	25.

**TUBES, CRYSTALS, TRANSISTORS:**

**REFERENCE DATA AND LITERATURE:**

TM 11-284.

RADIO SET  
AN/GRC-6

1 March 1964

Cog. Serv.: USA FSN: 5820-222-6417

USA Line Item No: 639500

	USA	USN	USAF	USMC
STATUS OR TYPE CLASS.:	Std B	Std		

## Manufacturer:

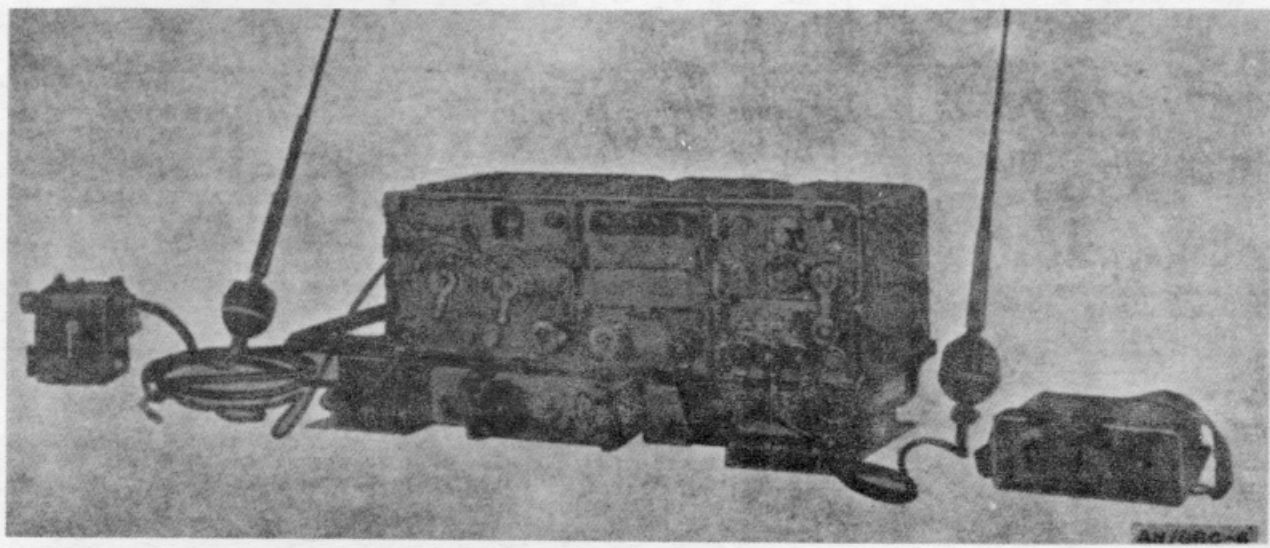

## FUNCTIONAL DESCRIPTION:

Radio Set AN/GRC-6 is a vehicular, short-range, fm (voice), two-way radio communication equipment having provision for retransmission, duplex, and remote control operation. It is one of the integrated series of radio equipment and is used by artillery units.

This equipment consists of a medium-power receiver-transmitter, designated as set 1, that operates in the frequency range assigned to an artillery unit. In addition, it includes a separate, low-power, short-range receiver-transmitter, designated as set 2, that operates in the frequency band common to armored, artillery, and infantry units. Vehicular interphone amplifier and control units for selecting desired modes of operation and service are included.

It generally operates in a vehicle from the 12- or 24-v vehicular storage battery; a hand generator and associated components (Modification Kit MX-898/GR) may be used for operation in semipermanent locations.

## RELATIONSHIP TO SIMILAR EQUIPMENT:

## TECHNICAL DESCRIPTION:

*Frequency Range in Mc:*

RT-67/GRC (set 1): 27.0 to 38.9

RT-70/GRC (set 2): 47.0 to 58.4.

*Type Modulation:* fm.*Type of Signal:* Voice and 1,600-cy fm tone signals.

**RADIO SET  
AN/GRC-6***Power Output:*

	<i>Transmitting</i>		
	<i>Low</i>		<i>High</i>
Set 1:	1 to 2 w		9 to 16 w.
Set 2:		0.5 w	
	<i>Receiving</i>		
	<i>Phone</i>	<i>Speaker</i>	<i>Retransmission</i>
Set 1:	50 mw	1 w	30 mw.
Set 2:			75 mw

*Power Requirements:* 110 to 280 w (depending upon mode of operation) at 12- or 24-v dc from vehicular storage battery.

*Major Units:*

1	AM-5/GRC	4 1/4" x 13" x 7 7/8"	15.5 lbs.
1	C-435/GRC	3 1/2" X 10 1/2" x 8 3/4"	12.
1	PP-109/GR or PP-112/GR	8" x 13" x 9"	33.
1	PP-281/GR or PP-282/GR	4 1/2" x 6" x 3"	6.

**TUBES, CRYSTALS, TRANSISTORS:****REFERENCE DATA AND LITERATURE:**

TM 11-284.

RADIO SET  
AN/GRC-7

1 March 1964

Cog. Serv.: USA FSN: 5820-230-0446

USA Line Item No: 639600

	USA	USN	USAF	USMC
STATUS OR TYPE CLASS.:	Std B	Std		

## Manufacturer:

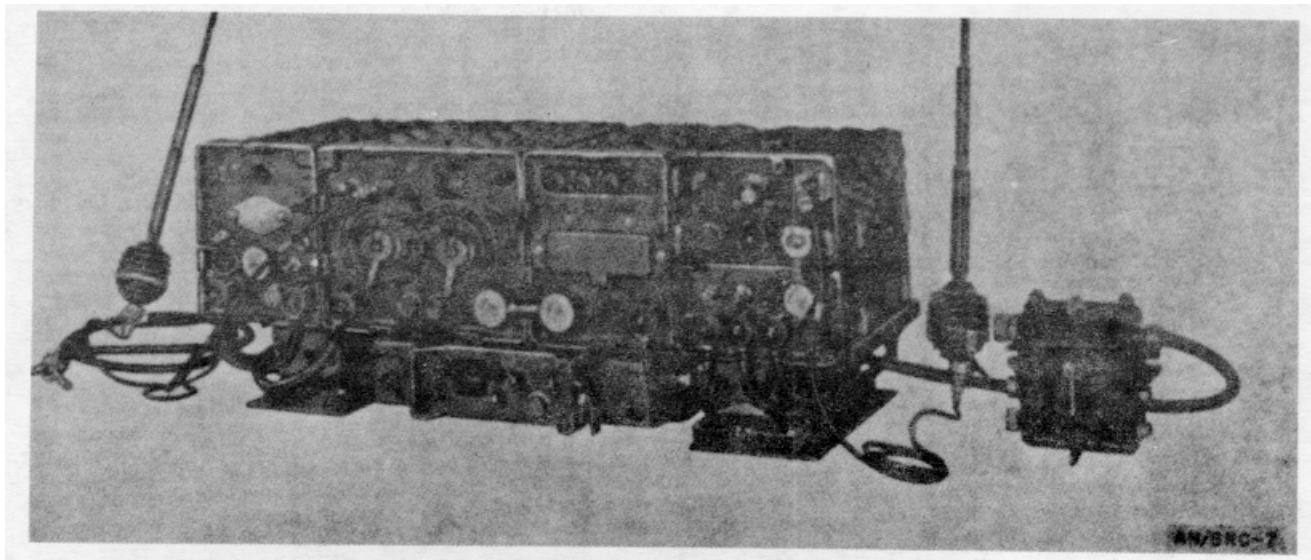

## FUNCTIONAL DESCRIPTION:

Radio Set AN/GRC-7 is a short-range, fm (voice), two-way communication equipment having provision for retransmission, duplex, and remote control operation. It is one of the integrated series of radio equipment used by units organic to an infantry division.

It consists of a medium-power radio receiver-transmitter component, designated as set 1, and an auxiliary radio receiver, both of which operate in the frequency range assigned to infantry units. In addition, it includes a separate low-power, short-range receiver-transmitter, designated as set 2, that operates in a frequency band common to armored, artillery, and infantry units. Vehicular interphone amplifier and control units for selecting desired modes of operation and service are included.

It generally operates in a vehicle from the 12- or 24-v vehicular storage battery; a hand generator and associated components (Modification Kit MX-898/GR) may be used for operation in semipermanent locations.

## RELATIONSHIP TO SIMILAR EQUIPMENT:

## TECHNICAL DESCRIPTION:

*Frequency Range in Mc:*

RT-8/GRC (set 1): 38.0 to 54.9.

RT-70/GRC (set 2): 47.0 to 58.4.

RC-110/GRC (auxiliary receiver): 38.0 to 54.9.

*Type Modulation:* fm.*Type of Signal:* Voice and 1,600-cy fm tone signals.

**RADIO SET  
AN/GRC-7**
*Power Output:*

	<i>Transmitting</i>		
	<i>Low</i>		<i>High</i>
Set 1:	1 to 2 w		9 to 16 w.
Set 2:		0.5 w	
	<i>Receiving</i>		
	<i>Phone</i>	<i>Speaker</i>	<i>Retransmission</i>
Set 1:	50 mw	1 w	30 mw.
Set 2:			75 mw
Auxiliary receiver:	50 mw	1 w	30 mw.

*Power Requirements:* 110 to 280 w (depending upon mode of operation), 12/24-v dc from vehicular storage battery.

*Major Units:*

1	AM-65/ORC	4 1/4" x 13" x 7 7/8"	15.5 lbs.
1	C-435/GRC	3 1/2" x 10 1/2" S 8 3/4"	12.
1	PP-109/GR or PP-112/GR	8" x 13" x 9"	33.
2	PP-281/GR or PP-282/GR	4 1/2" x 6" x 3"	6.
1	R-110/GRC	9" x 13" x 7 1/4"	35.
1	RT-68/GRC	9" x 13" x 11 1/4"	35.
1	RT-70/ORC	4 3/4" x 13" 7" x 7 1/8"	25.

**TUBES, CRYSTALS, TRANSISTORS:**
**REFERENCE DATA AND LITERATURE:**

TM 11-284.

RADIO SET  
AN/GRC-8

1 March 1964

Cog. Serv.: USA FSN: 5820-230-0454

USA Line Item No: 639700

	USA	USN	USAF	USMC
STATUS OR TYPE CLASS.:	Std B	Std		

Manufacturer:

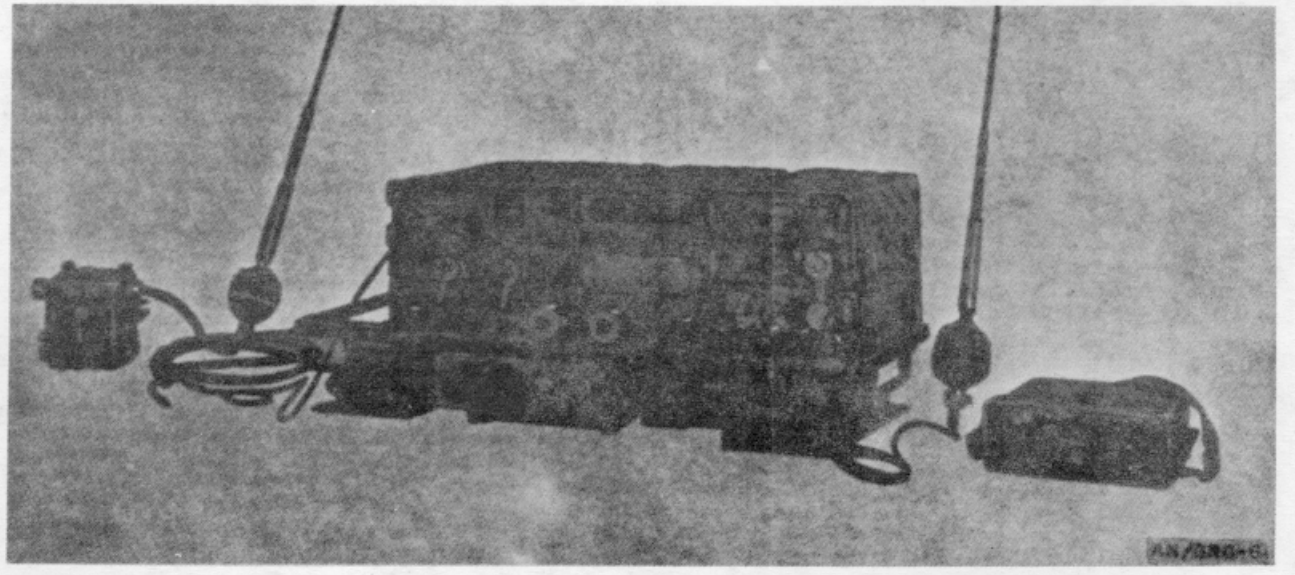
**FUNCTIONAL DESCRIPTION:**

Radio Set AN/ORC-8 is a short-range, fm (voice), two-way communication equipment for retransmission, duplex, and remote control operation. It is one of the integrated series of radio equipment used by units organic to an infantry division.

This equipment consists of a medium-power radio receiver-transmitter component, designated as set 1, operating in the frequency range assigned to infantry units, and a low-power receiver-transmitter, designated as set 2, which operates in a frequency band common to armored, artillery, and infantry units. It includes vehicular interphone amplifying equipment and control units for selecting desired modes of operation.

It generally operates in a vehicle from the 12- or 24-v vehicular storage battery; a hand generator and associated components (Modification Kit MX-898/GR) may be used for operation in semipermanent ground applications.

**RELATIONSHIP TO SIMILAR EQUIPMENT:****TECHNICAL DESCRIPTION:**

*Frequency Range in Mc:*

Receiver-Transmitter RT-68/GRC (set 1): 38.0 to 54.9.

Receiver-Transmitter RT-70/GRC (set 2): 47.0 to 58.4.

*Type Modulation:* fm.

*Type of Signal:* Voice and 1,600-cy fm tone signals.



**RADIO SET  
AN/GRC-8***Power Output:*

	<i>Transmitting</i>		
	<i>Low</i>		<i>High</i>
Set 1:	1 to 2 w		9 to 16 w
Set 2:		0.5 w	
	<i>Receiving</i>		
	<i>Phone</i>	<i>Speaker</i>	<i>Retransmission</i>
Set 1:	50 mw	1 w	30 mw
Set 2:			75 mw

*Power Requirement:* 110 to 280 w (depending upon mode of operation) from 12/24-v vehicular storage battery.

*Major Units:*

1	AM-65/GRC	4 1/4" x 13" x 7 7/8"	15.5 lbs.
1	C-435/GRC	3 1/2" x 10 1/2" x 8 3/4"	12
1	PP-109/GR or PP-112/GR	8" x 13" x 9"	33
1	PP-281/GR or PP-282/GR	4 1/2" x 6" x 3"	6
1	RT8T/GRC	9" x 13" x 11 1/4"	35
1	RT-70/GRC	4 3/4" x 13" x 7 1/8"	25

**TUBES, CRYSTALS, TRANSISTORS:****REFERENCE DATA AND LITERATURE:**

TM 11-284.

**RADIO SET  
AN/GRC-9( )**

1 March 1964

Cog. Serv.: USA FSN: 5820-193-8845

USA Line Item No: 639800

	USA	USN	USAF	USMC
<b>STATUS OR TYPE CLASS.:</b>	Std B	Used by	L/Std	

**Manufacturer:** Avco Mfg. Corp, Crosley Division.

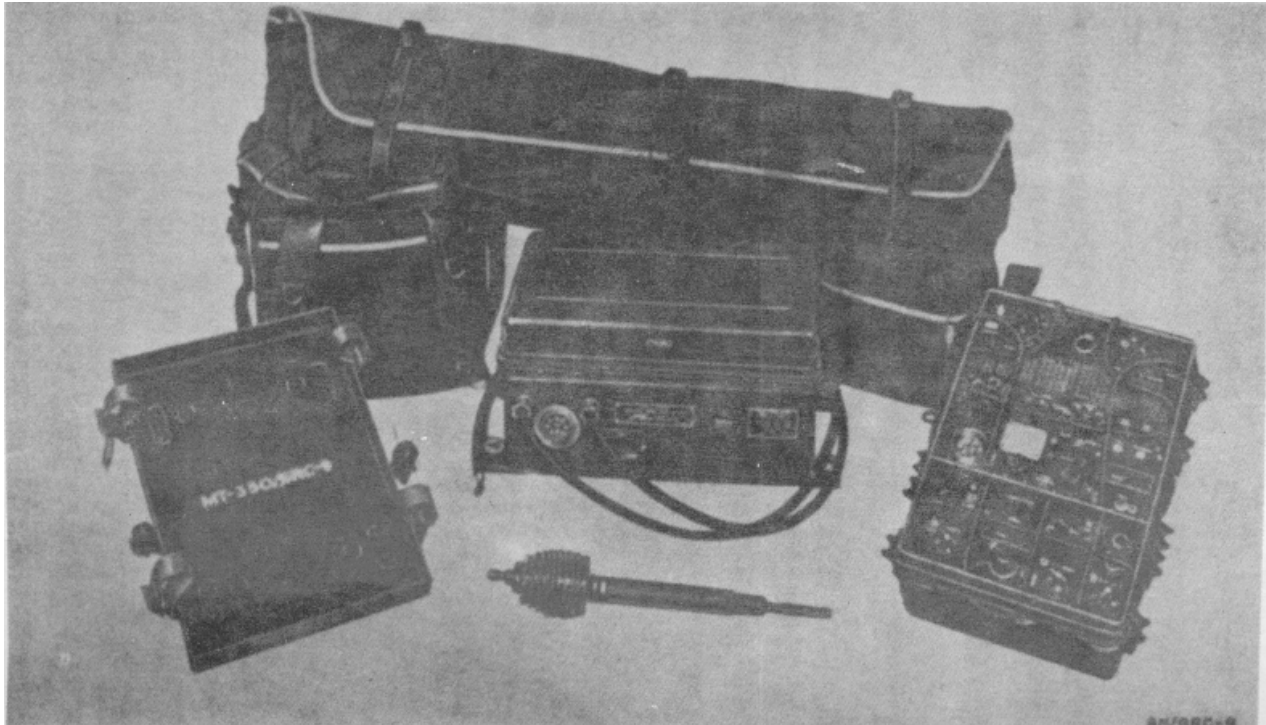

**FUNCTIONAL DESCRIPTION:**

Radio Set AN/GRC-9( ) is a lightweight portable or vehicular, 3-band, am (voice, tone, cw, and mew) equipment used by infantry and armored units for communication in the hf band.

This equipment consists of a receiver-transmitter (which can be either crystal- or master-oscillator controlled), a power supply, and related accessories. It uses a vehicular whip-type or long-wire antenna, one or two sets of headphones, or a loudspeaker connected at either of the headphone jacks.

Power is derived from a storage battery through the vibrator power unit or from a hand generator such as the GN-58.

During standby, the receiver uses Battery BA-48, which can be used in conjunction with the hand generator when the transmitter is being operated.

**RELATIONSHIP TO SIMILAR EQUIPMENT:**

**TECHNICAL DESCRIPTION:**

*Frequency Range in Mc:* 2 to 12 in 3 bands.

*Type Modulation:* am.

**RADIO SET  
AN/GRC-9( )**

*Type of Signal:* Voice, cw, or mew.

*Power Output:*

With PE-237: High, 7 w; low, 1 w (voice).

With GN-58: High, 3.6 w; low, 1.2 w (voice).

*Power Requirements:* Vibrator Power Supply PE-237 and 6-, 12-, or 24-v vehicular storage battery;

Generator GN-58; or Power Unit PE-162.

Battery BA-48 used for standby operation of receiver.

1	GN-58	10 1/2" x 7 1/2 x 8"	22.75 lbs.
---	-------	----------------------	------------

*Major Units:*

1	LS-203/U	7" x 4 3/4" x 3"	3
---	----------	------------------	---

1	RT-77/GRC-9	16" x 13" x 8"	32
---	-------------	----------------	----

1	PE-237	20" x 10 1/2" x 10 3/4"	74
---	--------	-------------------------	----

**TUBES, CRYSTALS, TRANSISTORS:****REFERENCE DATA AND LITERATURE:**

TM 11-263.

MIL-P-1167; MIL-R-12532A.

RADIO SET  
AN/GRC-10

1 March 1964

Cog. Serv.: USA FSN: 5820-570-5482

USA Line Item No: 639900

	USA	USN	USAF	USMC
STATUS OR TYPE CLASS.:	Std A			

Manufacturer: Motorola, Inc.

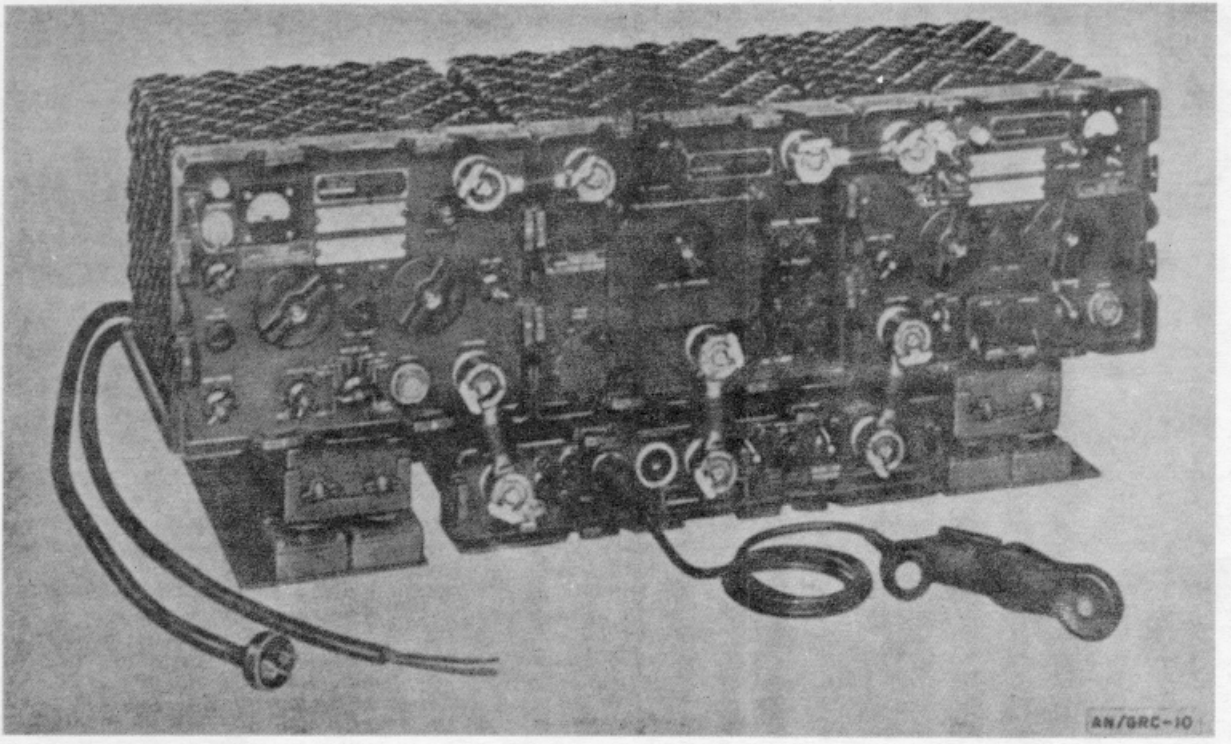
**FUNCTIONAL DESCRIPTION:**

Radio Set AN/GRC-10 is a vhf, fm receiving and transmitting equipment that may be used in single-channel push-to-talk communication applications, as a terminal station of a single-channel, line of sight, radio relay system, as a major component of a multichannel radio terminal set, or as part of a radio relay (repeater) set of a multichannel system. (See AN/GRC-39 and AN/GRC-40.

It consists essentially of an antenna system, a receiver, a transmitter, a power supply, a radio-set control, and an equipment rack.

It can be used in fixed-plant, ground, or vehicular applications.

**RELATIONSHIP TO SIMILAR EQUIPMENT:****TECHNICAL DESCRIPTION:**

*Frequency Range in Mc:* 54 to 70.9 (170 channels spaced 0.1 mc apart).

*Type Modulation:* fm.

*Type of Signal:* Voice; multichannel telephone, telegraph; facsimile; or various combinations of these.

**RADIO SET  
AN/GRC-10***Transmitter Power Output:* 10 w, 40 w.*Power Requirements, Each:* DY-94/GRC-10: 292 w, 115/230-v, 50/65-cy ac; 326 w, 26-v dc.*Major Units:*

1	DY-94/GRC-10	9 1/4" x 13" x 11 1/4"	59.5 lbs.
1	R-125/GRC-10	9 1/4" x 13" x 11 1/4"	31 lbs.
1	C-632/GRC-10	4" x 13" x 18"	18 lbs.
1	T-235/GRC-10	9 1/4" x 13" x 11 1/4"	34.5 lbs.

**TUBES, CRYSTALS, TRANSISTORS:****REFERENCE DATA AND LITERATURE:**

TM 11-614.

MIL-R-10511.

RADIO SET  
AN/GRC-13

15 March 1962

Cog. Serv.: USA FSN:

USA Line Item No: 640100

USA USN USAF USMC

STATUS OR TYPE CLASS.:

Manufacturer: (79089)

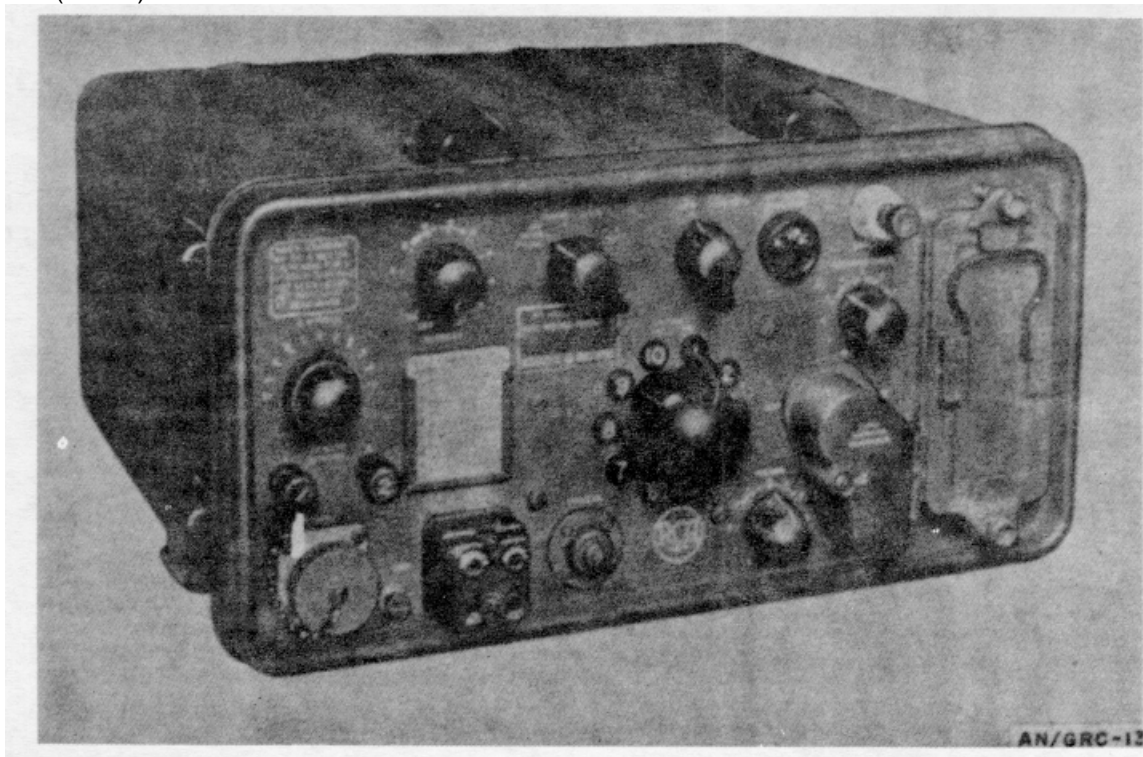
**FUNCTIONAL DESCRIPTION:**

Radio Set AN/GRC-13 provides complete facilities for two way radio communication by cw (A1) and voice modulated cw (A3) on any one of 10 preset channels. The complete equipment, including operating accessories, hand driven generator, and operating spares, is packed in a single field case to facilitate transportation in field operations. Power for transmission is provided by the hand driven generator. Power for reception is provided by either the hand generator or self-contained batteries.

Facilities are included for operating the equipment over a pair of telephone wires from a remote point up to one mile distant.

**RELATIONSHIP TO SIMILAR EQUIPMENT****TECHNICAL DESCRIPTION:**

*Frequency Range (Receive and Transmit):* 2-12 mc.

*Preset Frequencies:* Receive 10, Transmit 10.

*Frequency Control:* Crystal.

*Type of Emission (transmit):* A1 (cw), A3 (phone).

**RADIO SET  
AN/GRC-13**

*Nominal Power Input:* Receive-135 w, transmit-200 w.

*Nominal Output:*

Receiver: 25 mw into 300 ohms noninductive resistance.

Transmitter: Hand generator: A1-12 w, A3-4.5 w.

Auxiliary Power Supply: A1-20 w, A3-6 w.

*Intermediate Frequency:* 1600 kc.

*Receiver Sensitivity:* A1-10  $\mu\text{v}$ , A3-5  $\mu\text{v}$ , 30 percent modulation.

*Receiver Selectivity:* 6 db down at 7.5 kc off resonance.

*Output Impedance:* Receiver Hedaet-300 ohms, transmitter antenna 3000 ohms.

*Input Impedance:* Receiver--40 ohms at input to rf stage, transmitter 100 ohms (microphone).

*Audio Frequency Response (Receiver and Transmit):* 400-3000 cy.

*Crystals:*

Frequency: 10 channel, 3.6-10.4 mc; 1 reference, 1600 kc.

*Major Units:*

1	AN/GRC-13	18" x 44 1/4" x 20 1/4"	257 lbs.
1	MX-1012	19 1/4" x 27 1/2" x 22 7/8"	118 lbs.

**TUBES, CRYSTALS, TRANSISTORS:**

**REFERENCE DATA AND LITERATURE:**

NAVSHIPS 91235.

RADIO SET  
AN/GRC-19( )

1 March 1964

Cog. Serv.: USA FSN: 5820-030-0155

USA Line Item No: 640701

	USA	USN	USAF	USMC
STATUS OR TYPE CLASS.:	Std A		Std	

Manufacturer: Collins Radio Co.

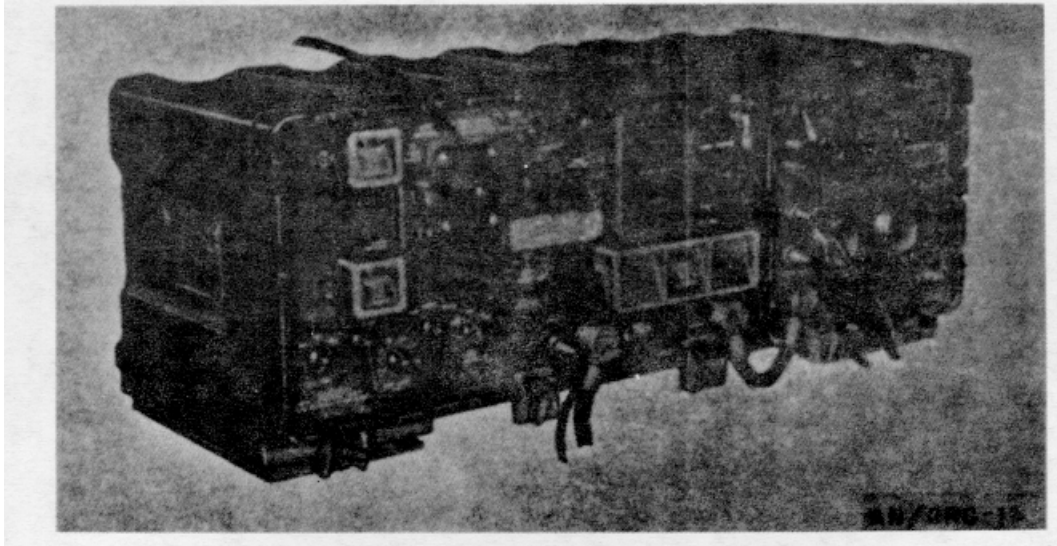
**FUNCTIONAL DESCRIPTION:**

Radio Set AN/GRC-19( ) is a mobile or portable, hf equipment used for transmitting and receiving voice, radiotelegraph, and, in conjunction with suitable associated equipment, for radioteletype communication. Its transmitter may be remotely controlled at a maximum distance of 75 feet from the operating site by means of an appropriate control unit.

This equipment consists essentially of a transmitter, receiver, and whip antenna but requires an installation kit suited to the vehicle in which it is used for mobile operation. Both a 28-volt power source and a half-wave, center-fed Hertz array (Antenna Group AN/GRA-12) are required for fixed-station operation.

This radio set has a provision for simultaneous voice and radioteletype service, and it can operate on a simplex or duplex basis or in radio-relay applications.

**RELATIONSHIP TO SIMILAR EQUIPMENT:****TECHNICAL DESCRIPTION:**

*Frequency Range in Mc:*

*Transmitter:* 1.5 to 20 in 10 bands.

*Receiver:* 0.5 to 32 in 32 bands.

*Type Modulation:* am.

*Type of Signal:* cw, fsk, voice, or fsk and voice composite.

*Power Output:* 100 w.

*Power Requirement:* 28.5-v dc.



**RADIO SET  
AN/GRC-19( )**

*Major Units:*

R-392/URR

11 1/2" x 14 3/16" x 11 1/4"

52.3 lbs.

T-195/GRC-19

11 1/2" x 14 1/8" x 22"

125 lbs.

**TUBES, CRYSTALS, TRANSISTORS:**

**REFERENCE DATA AND LITERATURE:**

TM 11-274.

USA MIL-R-10473.

RADIO SET  
AN/GRC-26( )

1 March 1964

Cog. Serv.: USA FSN: 5820-186-9250

USA Line Item No: 641100

	USA	USN	USAF	USMC
STATUS OR TYPE CLASS.:	Std A		Std	

Manufacturer: Avco Mfg Co, Crosley Div

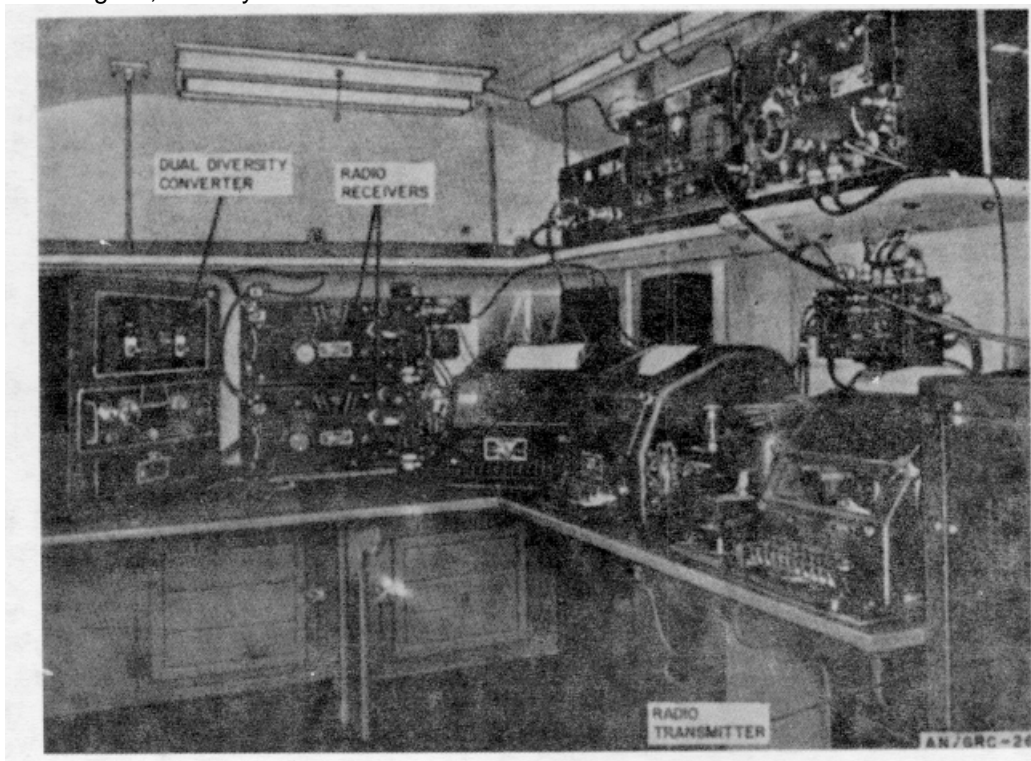
**FUNCTIONAL DESCRIPTION:**

Radio Set AN/GRC-26( ) is a mobile, long-range, am (voice, tone, cw, or frequency-shift-keying teletypewriter) transmitting and receiving equipment used for point-to-point and ground-to-air communication.

This equipment consists of radio, teletypewriter, and associated items installed in a field-type shelter mounted on a 2 1/2-ton, 6 x 6, cargo truck, with a 1-ton trailer on which a field power unit is installed. Whip-type and doublet antenna components are included.

This set is used primarily for radioteletype operation on a full-duplex basis and uses dual-diversity reception. It can be operated on a half-duplex basis and includes a voice channel serving as an order wire. The equipment normally is operated at the halt but can provide voice or cw communication while in motion. The voice channel can be used as a voice-patching facility, simultaneously with radioteletype operation in emergencies or when otherwise required.

The entire equipment can be transported by a C-82 type aircraft.

Later models of this set are composed of later and improved types of transmitting, receiving, and reproducing equipment. Functionally, the various models generally are interchangeable.

**RELATIONSHIP TO SIMILAR EQUIPMENT:**

**RADIO SET  
AN/GRC-26( )**

**TECHNICAL DESCRIPTION:**

*Frequency Range in Mc:* Receiver: 1.5 to 18.0.

Type Modulation: am.

Type of Signal: Voice, tone, cw, fsk, or voice and fsk composite.

Power Output:

Voice: 300 w.

Cw or Fsk: 400 w.

*Power Requirements:* approx 3, 000 w, 115-v 60cy ac.

*Major Units:*

1	BC-39-( )	14 1/2" x 23 1/2" x 11 1/4"	48 lbs.
1	C345A/MRC-2	3 1/2" x 2" x 6"	4 lbs.
1	C-392B/TRA-7	11 27/32" x 12 5/16" x 19 1/8"	185 lbs.
1	CV-31B/TRA-7	20 7/8" x 17 5/16" x 19 1/4"	200 lbs.
1	O-39B/TRA-7	12 5/8" x 16 3/8" x 19"	110 lbs.
1	O-41/TRA-7		
1	TT-56/MGC	13 1/2" x 21" x 25"	86 lbs.
1	PE 95-G	38 1/2" x 28 1/4" x 67 1/2"	1,556 lbs.
2	R-336/GRC-26	9 1/4" X 10 3/4" x 18"	65 lbs.
1	C-535/GRC-26	12" x 7" x 3 3/4"	4.5 lbs.
1	T-213/GRC-26	45" x 30" x 31"	400 lbs.
1	S-55/GRC	79 1/2" x 81 1/2" x 145"	3,100 lbs.
1	BC-614-( )	16 1/2" x 9 3/4" x 9 1/2"	30 lbs.
2	TT-55/MGC	15 1/2" x 18" x 18"	60 lbs.
1	Trailer, 1-ton, 2-wheel	67 1/2 x 73" x 145 1/2"	1,300 lbs.

**TUBES, CRYSTALS, TRANSISTORS:**

**REFERENCE DATA AND LITERATURE:**

TM 11-264.

USA 71-3334; MIL-R-11812.

RADIO SET  
AN/GRC-27

26 November 1958

Cog. Serv.: USA FSN: 5820-522-4267

USA Line Item No:

	USA	USN	USAF	USMC
STATUS OR TYPE CLASS.:			Std	

Manufacturer: Collins Radio Co.

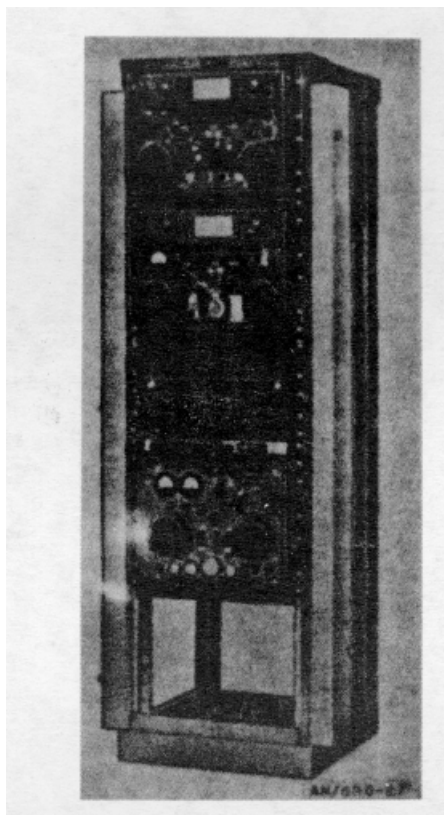
**FUNCTIONAL DESCRIPTION:**

Radio Set AN/GRC-27 is an ultra-high-frequency transmitting and receiving unit intended primarily for ground-to-air communications. It is also applicable for use on naval vessels for ship-to-air and ship-to-ship communication through an adaptor which makes the control circuits compatible with standard shipboard remote control system.

The set is comprised of an indefinite quantity of radio transmitters, modulator-power supplies, radio receivers, distortion panel components, relay racks, antennas, and the necessary interconnecting cables. A typical ground-to-air communication set up for control-tower operation may consist of four complete transmitter-receiver equipments. Three of these are used for control of aircraft; the fourth as a spare. Requirements for naval operations vary as far as number of component parts are concerned.

This equipment is designed to operate in any one of 10 preset channels.

Radio Receiver R-278/GR monitors either one of two crystal-controlled, preset, standby, guard channels. Modulator-Power Supply MD-129/GR supplies power for Radio Transmitter T-217/GR in cycles of 1 minute ON and 5 minutes OFF.

Equipment can be requisitioned as required on an individual project, or installation basis.

**RADIO SET  
AN/GRC-27**

**RELATIONSHIP TO SIMILAR EQUIPMENT:**

**TECHNICAL DESCRIPTION:**

*Transmitter:*

Frequency Range in Mc: 225 to 399.9.  
 Frequency Control: Crystal synthesizer.  
 Number of Channels: 1, 750; spaced at 100 kc.  
 Preset Channels: 10.  
 Type Emission: Voice, mcw.  
 Type Modulation: am.  
 Power Output: 100 w (nominal).

*Receiver:*

Frequency Range in Mc: 225 to 399.9.  
 Type Reception: Voice, mew.  
 AF Response:  
     Narrow: 400 to 3,000 cps.  
     Broad: 200 to 20,000 cps.  
 Features: Avc and squelch circuit.  
 Power Output: 3 w into 600 ohm load.

*Power Requirements:* Minimum installation 2, 310 w (approx), 115/230-v 50-60-cy 1-phase ac.

*Major Units:*

MD-129B/GR	19" x 12 1/4" x 20"	140.0 lbs.
MT-86/GR	22 5/8" x 72 1/2" x 21 3/8"	96.0 lbs.
R-278B/GR	19" x 12 1/4" x 20"	115.0 lbs.
T-217A/GR	19" x 12 1/4" x 20"	130.0 lbs.

**TUBES, CRYSTALS, TRANSISTORS:**

**REFERENCE DATA AND LITERATURE:**

TO 31R2-2GRC27-64.  
 TO 31R-1-1.  
 BuShips Dwg RE 46D 2022B;  
 BuShips Dwg RE 46F 2023B.

RADIO SET  
AN/GRC-3026 November 1958  
Cog. Serv.: USA FSN:  
USA Line Item No:

	USA	USN	USAF	USMC
STATUS OR TYPE CLASS.:			L/Std	

Manufacturer:

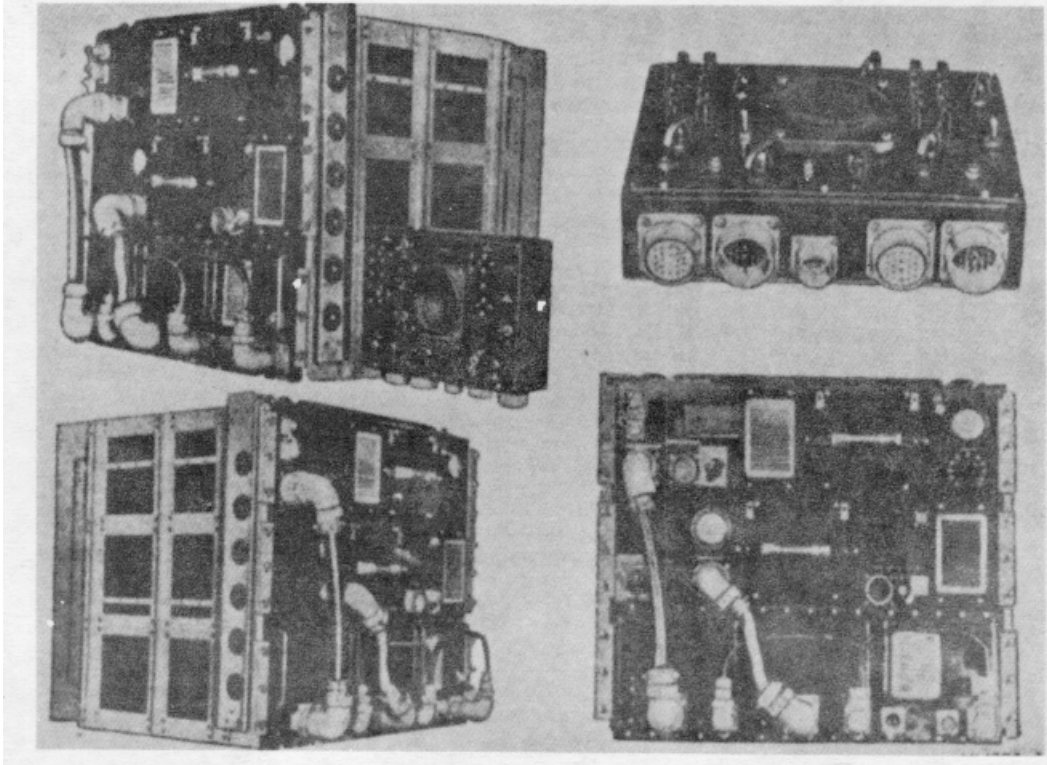
**FUNCTIONAL DESCRIPTION:**

Radio Set AN/GRC-30 is a ground-operated, two-way, dual-channel, very high-frequency and ultra-high-frequency receiver-transmitter. It is normally used to provide communication between ground controlled approach equipment and aircraft.

This equipment provides 20 crystal-controlled, preset channels-10 channels in each receiver-transmitter unit.

Radio Receiver RT-420/GRC-30 monitors one channel in both the very high-frequency and ultra-high-frequency bands, and has provision for a 1,600-ohm balanced output for direction finding and navigation applications.

Discone Antenna Group OA-291/GRC-30 is normally used with this equipment; it can be remotely controlled over distances up to 5 miles over standard telephone lines.

The set normally is used with Radar Sets AN/FPN-16, AN/CPN-4, AN/CPN-18, and Radio Set AN/MPN-1, and other ground controlled approach radar equipment.

**RELATIONSHIP TO SIMILAR EQUIPMENT:**

**RADIO SET  
AN/GRC-30**

**TECHNICAL DESCRIPTION:**

*Frequency Range:*

Radio Receiver-Transmitter RT-226/GRC-30: 100 mc to 180 mc; 10 channels.

Radio Receiver-Transmitter RT-227/GRC-30: 225 mc to 399.9 mc; 10 channels.

Radio Receiver R-420/GRC-30: 100 mc to 160 mc and 225 mc to 399.9 mc; 2 channels in each range.

*Frequency Control:* Crystal.

*Type Modulation:* am.

*Type Signal:* Voice, tone.

*Power Output:*

Transmitter: 12 w (each).

Receiver: 1.2 w (each).

*Power Requirements:* 3,100 w 115/230-v 5-60cy 1-phase ac.

*Major Units:*

1	Radio Receiver R-420/GRC-30	7 7/8" x 7 3/4" x 21"	45 lbs.
1	Radio Receiver-Transmitter RT-226/GRC-30	24 1/2" x 6 3/4" x 21"	125 lbs.
1	Radio Receiver-Transmitter RT-227/GRC-30	24 1/2" x 6 3/4" x 21"	145 lbs.
1	Radio Set Control C-896/GRC-30	12" x 7 3/4" x 21"	45 lbs.
1	Radio Set Control C-897/GRC-30	12" x 7 3/4" x 21"	45 lbs.

**TUBES, CRYSTALS, TRANSISTORS:**

**REFERENCE DATA AND LITERATURE:**

RADIO SET  
AN/GRC-38( )

1 March 1964

Cog. Serv.: USA FSN: 5820-546-6516

USA Line Item No: 641300

	USA	USN	USAF	USMC
STATUS OR TYPE CLASS.:	Std C		L/Std	

Manufacturer: The Hallicrafters Co.

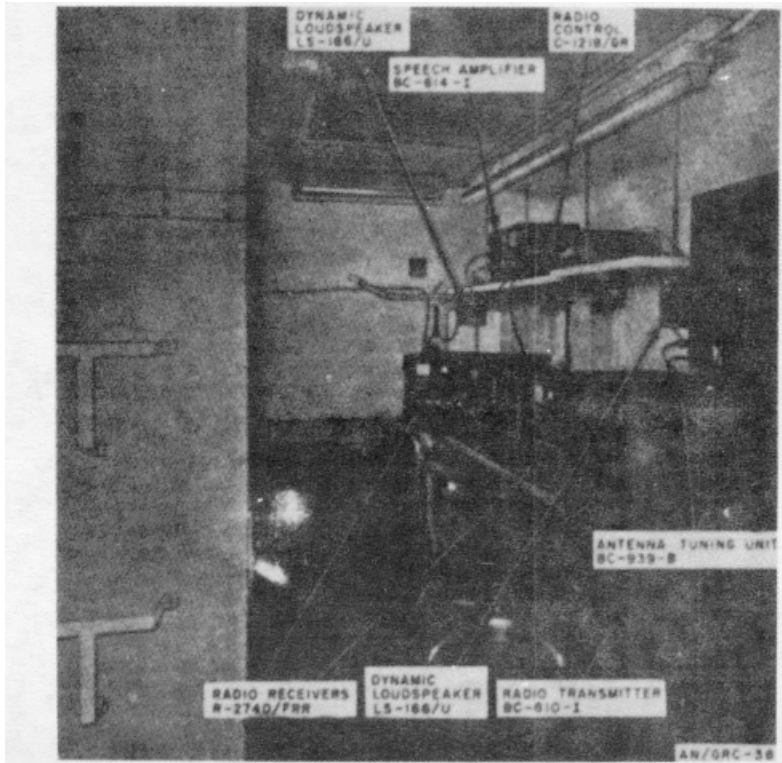
**FUNCTIONAL DESCRIPTION:**

Radio Set AN/GRC-38( ) is a mobile or fixed transmitting and receiving station used for ground-to-ground and ground-to-air communication applications.

It consists of a transmitter, two receivers, a speech amplifier, an antenna tuning unit, and a radio set control. All operating components are housed in a shelter, which is transportable in a 2 1/2-ton, 6 by 6 cargo truck.

This equipment requires a 115-volt ac commercial power source for fixed station operation, but includes a trailer-mounted generator for mobile use.

**RELATIONSHIP TO SIMILAR EQUIPMENT:****TECHNICAL DESCRIPTION:**

*Frequency Range in Mc:*

Receiver: 0.54 to 54 in six bands.

Transmitter: 2 to 18.

*Type Modulation:* am.



**RADIO SET  
AN/GRC-38( )**

*Type of Signal:* Voice, cw.

*Transmitter Power Output:*

Cw: 400 w.

Voice: 300 w.

*Power Requirements:*

Commercial Power: 5.4 kw, 115-v 60-cy 1-phase ac.

Power Unit PE-95-G Rated Output: 10 kw, 120/240-v 60-cy 1-phase ac.

*Major Units:*

1	BC-939-B	24 1/4" x 9 3/32" x 13 5/16"	
2	R-274D/FRR		58 lbs.
1	C-1218/GR	19" x 12" x 5 1/2'	
1	BC-610-I		401 lbs.
1	S-69/GRC	142" x 83 1/2" x 79 1/2"	7,400 lbs.
1	BC-614-I		31 lbs.

**TUBES, CRYSTALS, TRANSISTORS:**

**REFERENCE DATA AND LITERATURE:**

TM 11-281B.

Spec 71-61834.

RADIO TERMINAL SET  
AN/GRC-39

1 March 1964

Cog. Serv.: USA FSN: 5820-309-3213

USA Line Item No: 657225

	USA	USN	USAF	USMC
STATUS OR TYPE CLASS.:	Std A			

Manufacturer:

For illustration see AN/GRC-10, page 377

**FUNCTIONAL DESCRIPTION:**

Radio Terminal Set AN/GRC-39 consists essentially of two Radio Sets AN/GRC-10 (one in use and one spare) and two power units. When it is operated in conjunction with Telephone Terminal AN/TCC-3 and associated equipment, it can provide duplex facilities for four voice channels or various combinations of voice, facsimile, and telegraph channels.

It can be utilized in fixed-plant, ground-based, or vehicular applications.

**RELATIONSHIP TO SIMILAR EQUIPMENT:****TECHNICAL DESCRIPTION:**

*Frequency Range in mc:* 54 to 70.9 (170 channels spaced 0.1 mc apart).

*Type Modulation:* fm.

*Type of Signal.* Voice, multichannel telephone, telegraph; facsimile; or various combinations of these.

*Transmitter Power Output:* 10 w, 40 w.

*Power Requirements:* Each DY-94/GRC-10: 292 w, 115/230 v 50/65-cy ac; 326 w, 26 v dc.

Major units:

1	LS-166/U	5" x 3 1/8" x 5"	4 lbs.
2	PE-75-( )	24 1/2" x 19" x 36"	298 lbs.
2	AN/GRC-10	See AN/GRC-10.	

**TUBES, CRYSTALS, TRANSISTORS:****REFERENCE DATA AND LITERATURE:**

TM 11-614.

RADIO REPEATER SET  
AN/GRC-40

1 March 1964

Cog. Serv.: USA FSN: 5820-309-3215

USA Line Item No: 636290

	USA	USN	USAF	USMC
STATUS OR TYPE CLASS.:	Std A			

**Manufacturer:**

For illustration see AN/GRC-10, page 377.

**FUNCTIONAL DESCRIPTION:**

Radio Repeater Set AN/GRC-40 consists primarily of three Radio Sets AN/GRC-10 (two in use and one spare) and two power units. It operates as a complete radio-relay station between two Radio Terminal Sets AN/GRC-39.

This set can operate in series between terminal stations to extend the range of the system. Normally, the maximum number of relay stations is limited to five by the accumulated background noise in each system.

Operation of each repeater station is limited to line-of-sight in each of two directions.

**RELATIONSHIP TO SIMILAR EQUIPMENT:****TECHNICAL DESCRIPTION:**

*Frequency Range in Mc:* 54 to 70.9 (170 channels spaced 0.1 mc apart).

*Type Modulation:* fm.

*Type of Signal:* Voice, multichannel telephone, telegraph; facsimile; or various combinations of these.

*Major Units:*

1	LS-166/U	5" x 3 1/8" x 5"	4 lbs.
2	P75-( )	24 1/2" x 19" x 36"	298 lbs.
3	AN/GRC-10	See AN/GRC-10.	

**TUBES, CRYSTALS, TRANSISTORS:****REFERENCE DATA AND LITERATURE:**

TM 11-614.

RADIO TELETYPEWRITER SET  
AN/GRC-46

1 March 1964

Cog. Serv.: USA FSN: 5815-570-5488

USA Line Item No: 657222

	USA	USN	USAF	USMC
STATUS OR TYPE CLASS.:	Std A			

Manufacturer:

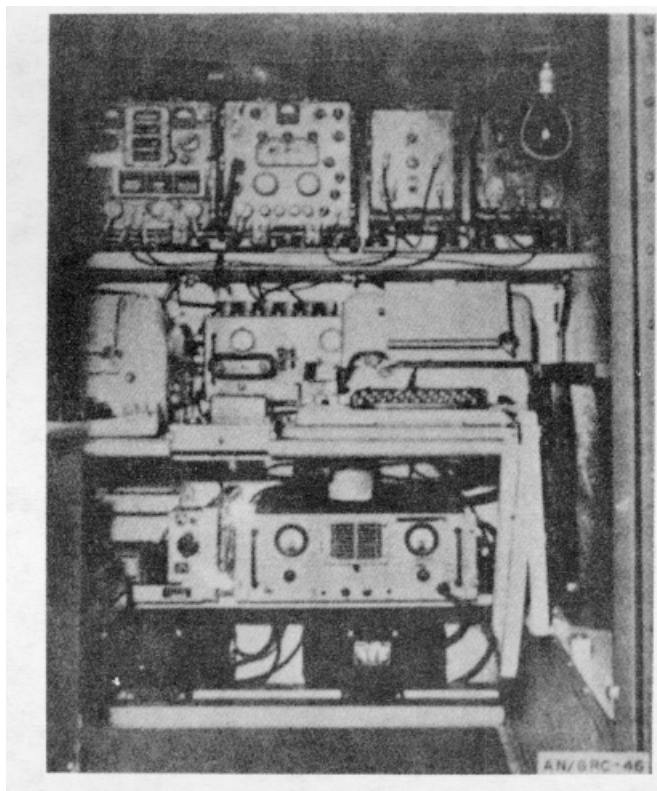
**FUNCTIONAL DESCRIPTION:**

Radio Teletypewriter Set AN/GRC-46 is an assembly of transmitting, receiving, and teletypewriter equipment arranged in a shelter and mounted on a vehicle. It is a complete mobile radioteletype station.

This set can provide either separate or simultaneous transmission and reception of voice and radio-teletype signals. It may be operated while the vehicle is in motion.

**RELATIONSHIP TO SIMILAR EQUIPMENT:****TECHNICAL DESCRIPTION:**

*Frequency Range in Mc:*

Transmitter: 1.5 to 20.0.

Receiver: 1.5 to 32.0.

*Type Modulation:* am.

*Type of Signal:* cw, voice, fsk radioteletype.

*Power Output:* 100 w.

**RADIO TELETYPEWRITER SET  
AN/GRC-46**

*Power Requirements:* 1,500 w, 28-v dc.

*Major Units:*

1	Frequency Shift Converter CV-278/GR	13" x 7 1/4" x 9".	
1	Radio Modulator MD-203/GR	13" x 7 1/4" x 9".	
1	Radio Receiver R-392/URR	11 1/2" x 14 1/8" x 11"	52 lbs.
1	Radio Transmitter T-195/GRC-19.		
1	Shelter S-89/G.		
1	Teletypewriter T-98/FG.		

**TUBES, CRYSTALS, TRANSISTORS:**

**REFERENCE DATA AND LITERATURE:**

TB SIG 302.  
TM 11-656-10.  
TM 11-656-25.

RADIO SET  
AN/GRC-75

26 November 1958

Cog. Serv.: USA FSN: 5820-581-2104

USA Line Item No:

	USA	USN	USAF	USMC
STATUS OR TYPE CLASS.:	Std A			

Manufacturer:

No illustration available

**FUNCTIONAL DESCRIPTION:**

Radio Set AN/GRC-75 is a transportable very-high-frequency transmitting and receiving equipment. It is designed primarily for use with multichannel carrier telephone terminal apparatus.

**RELATIONSHIP TO SIMILAR EQUIPMENT:****TECHNICAL CHARACTERISTICS:***Frequency Range:* 50 mc to 100 mc.*Number of Bands:* 1.*Number of Channels:* 200.*Type Emission:* fm.*Power Output:* 120 w.*Power Requirements:* 115 v 50-cy 1-phase ac or 230 v 60-cy 1-phase ac.*Major Units:***TUBES, CRYSTALS, TRANSISTORS:****REFERENCE DATA AND LITERATURE:**

RADIO TERMINAL SET  
AN/GRC-76

26 November 1958

Cog. Serv.: USA FSN:

USA Line Item No:

---

	USA	USN	USAF	USMC
STATUS OR TYPE CLASS.:	Std A			

---

Manufacturer:

No illustration available

**FUNCTIONAL DESCRIPTION:**

Radio Terminal Set AN/GRC-76 receives and transmits multichannel voice (12 voice plus 1 order wire), telegraph, teletypewriter and/or facsimile in conjunction with appropriate multichannel subcarrier telephone carrier equipment.

**RELATIONSHIP TO SIMILAR EQUIPMENT****TECHNICAL DESCRIPTION:***Frequency Range in Mc: 50 to 100.**Power Requirement: 115 v 60-cy 1-phase c.**Major Units:***TUBES, CRYSTALS, TRANSISTORS:****REFERENCE DATA AND LITERATURE:**

RADIO REPEATER SET  
AN/GRC-77

26 November 1958  
Cog. Serv.: USA FSN:  
USA Line Item No:

---

	USA	USN	USAF	USMC
STATUS OR TYPE CLASS.:	Std A			

---

Manufacturer:

No illustration available

**FUNCTIONAL DESCRIPTION:**

Radio Repeater Set AN/GRC-77 receives and retransmits multichannel voice (12 voice plus 1 order wire), telegraph, teletypewriter and/or facsimile and provides a simultaneous two-way radio relay circuit.

**RELATIONSHIP TO SIMILAR EQUIPMENT:****TECHNICAL DESCRIPTION:**

*Frequency Range in Mc:* 50 to 100.

*Number of Band:* 1.

*Number of Channels:* 200.

*Method Operation:* Continuous multiplexing.

*Type Emission:* fm.

*Power Requirements:* 115 v 50-cy 1-phase ac or 230 v 60-cy 1-phase ac.

*Major Unit:*

**TUBES, CRYSTALS, TRANSISTORS:****REFERENCE DATA AND LITERATURE:**



RADIO SET  
AN/GRC-78

26 November 1958

Cog. Serv.: USA FSN: 5820-581-2105

USA Line Item No:

	USA	USN	USAF	USMC
STATUS OR TYPE CLASS.:	Std A			

Manufacturer:

No illustration available

**FUNCTIONAL DESCRIPTION:**

Radio Set AN/GRC-78 is a transportable very-high-frequency and ultra-high-frequency transmitting and receiving equipment. It is used with appropriate multichannel carrier telephone terminal apparatus.

**RELATIONSHIP TO SIMILAR EQUIPMENT****TECHNICAL DESCRIPTION:***Transmitter:*

Frequency Range in Mc: 100 to 225 and 400 to 600.

Number of Bands: 2.

Channels: 383.

Type Modulation: fm.

Power Output: 120 w.

*Receiver:*

Frequency Range in Mc: 100 to 225 and 400 to 600.

Number of Bands: 2.

Channels: 383.

*Power Requirements:* 115 v 50-cy 1-phase ac or 230 v 60-cy 1-phase ac.*Major Units:***TUBES, CRYSTALS, TRANSISTORS:****REFERENCE DATA AND LITERATURE:**

RADIO REPEATER SET  
AN/GRC-80

26 November 1958  
 Cog. Serv.: USA FSN:  
 USA Line Item No:

	USA	USN	USAF	USMC
STATUS OR TYPE CLASS.:	Std A			

**Manufacturer:**

No illustration available

**FUNCTIONAL DESCRIPTION:**

Radio Repeater Set AN/GRC-80 receives and retransmits multichannel voice (12 voice plus 1 order wire), telegraph, teletypewriter and/or facsimile, and provides a simultaneous two-way radio relay circuit.

**RELATIONSHIP TO SIMILAR EQUIPMENT:****TECHNICAL DESCRIPTION:**

*Frequency Range in Mc:* 100 to 225 and 400 to 600.

*Number of Bands:* 2.

*Number of Channels:* 383

*Type Modulation:* fm

*Power Requirements:* 115 v 50-cy 1-phase ac or 230 v 60-cy 1-phase ac.

*Major Units:*

**TUBES, CRYSTALS, TRANSISTORS:****REFERENCE DATA AND LITERATURE:**

RADIO SET  
AN/GRC-81

26 November 1958

Cog. Serv.: USA FSN: 5820-578-5451

USA Line Item No: 642100

	USA	USN	USAF	USMC
STATUS OR TYPE CLASS.:	Std A			

Manufacturer:

No illustration available

**FUNCTIONAL DESCRIPTION:**

Radio Set AN/GRC-81 is a transportable very-high-frequency and ultra-high-frequency transmitting and receiving equipment. It is used with appropriate multichannel carrier telephone terminal apparatus.

**RELATIONSHIP TO SIMILAR EQUIPMENT,****TECHNICAL DESCRIPTION:**

*Frequency Range in Mc: 225 to 400.*

*Number of Bands: 1.*

*Number of Channel: 175.*

*Power Output: 120 w.*

*Type Modulation: fm.*

*Power Requirements: 115 v 50-cy 1-phase ac or 230 v 60-cy 1-phase ac.*

*Major Units:*

**TUBES, CRYSTALS, TRANSISTORS:****REFERENCE DATA AND LITERATURE:**

RADIO TERMINAL SET  
AN/GRC-82

26 November 1958

Cog. Serv.: USA FSN: 5820-578-5413

USA Line Item No:

	USA	USN	USAF	USMC
STATUS OR TYPE CLASS.:	Std A			

Manufacturer:

No illustration available

**FUNCTIONAL DESCRIPTION:**

Radio Terminal Set AN/GRC-82 receives and transmits multichannel voice (12 voice plus 1 order wire), telegraph, teletypewriter and/or facsimile in conjunction with appropriate multichannel subcarrier telephone carrier equipment such as Telephone Terminal AN/TCC-7.

**RELATIONSHIP TO SIMILAR EQUIPMENT:****TECHNICAL DESCRIPTION:**

*Frequency Range in Mc:* 225 to 400.

*Power Requirements:* 115 v 0-cy 1-phase c or 230 v 60-cy 1-phase ac.

*Major Units:*

**TUBES, CRYSTALS, TRANSISTORS:****REFERENCE DATA AND LITERATURE:**

DIRECTION FINDER SET  
AN/GRD-5

26 November 1958  
 Cog. Serv.: USA FSN: 5825-642-8184  
 USA Line Item No:

	USA	USN	USAF	USMC
STATUS OR TYPE CLASS.:			L/Std	

Manufacturer: Federal Telecommunications Laboratory, Inc.

No illustration available

**FUNCTIONAL DESCRIPTION:**

Direction Finder Set AN/OGRD-5 is a receiver and azimuth indicator used in conjunction with ground control approach equipment in locating and homing aircraft. It is installed in a truck or at a control tower installation.

This equipment provides instantaneous azimuth indications of aircraft in flight, on the basis of radio frequency transmissions from the aircraft. It features automatic sensing means so that a single bearing is presented at all times while a signal is being received. Presence of a signal is indicated visually by means of a neon tube.

Direction Finder Set AN/GRD-5 is the production model of Experimental Direction Finder Adaptor for Radar Equipment CXGH-2.

**RELATIONSHIP TO SIMILAR EQUIPMENT:**

**TECHNICAL DESCRIPTIONS:**

*Frequency Range:*

Manual Tuning: 100 mc to 160 mc.  
 Actual Frequency: 120 mc to 156 mc.

*Frequency Control:* Crystal or continuously variable.

*Operational Range:* Max of 135 miles when using a 25-ft ant. and receiving from a std aircraft transmitter at an alt of 10,000 ft.

*Type Receiver:* Superheterodyne.

*Type Reception:* A1, A2, A3.

*Intermediate Frequency:* 15.09 mc.

*Output:* Greater than 500 mw into a 600-ohm load; less than 10% distortion.

*Impedance:*

Input: 50 ohms.  
 Output: 600 ohms.

*Features:* Squelch and noise limiter circuits to eliminate audio output other than from signal.

*Antenna:* Eight element H-type Adcock with broad band dipoles.

*Mounting:*

Receiver: Table or rack.  
 Azimuth Indicator: Table.

*Power Requirements:* 276 w 115 v ( $\pm 5.75$  v) 60-cy ( $\pm 6$  cy) 1-phase ac.

*Major Units:*

1	ID-317/GRD-5	13" x 6 3/16" x 6 5/8"	8.0 lbs.
1	R-499/GRD-5	8 25/32" x 17 17/32" x 19 7/32"	92.0 lbs.

**TUBES, CRYSTALS, TRANSISTORS:**

**REFERENCE DATA AND LITERATURE:**

D-52.

RADIO SET  
AN/GRR-5( )

1 March 1964

Cog. Serv.: USA FSN: 5820-248-3508

USA Line Item No: 641600

	USA	USN	USAF	USMC
STATUS OR TYPE CLASS.:	Std A		Std	

Manufacturer: Zenith Radio Corp.

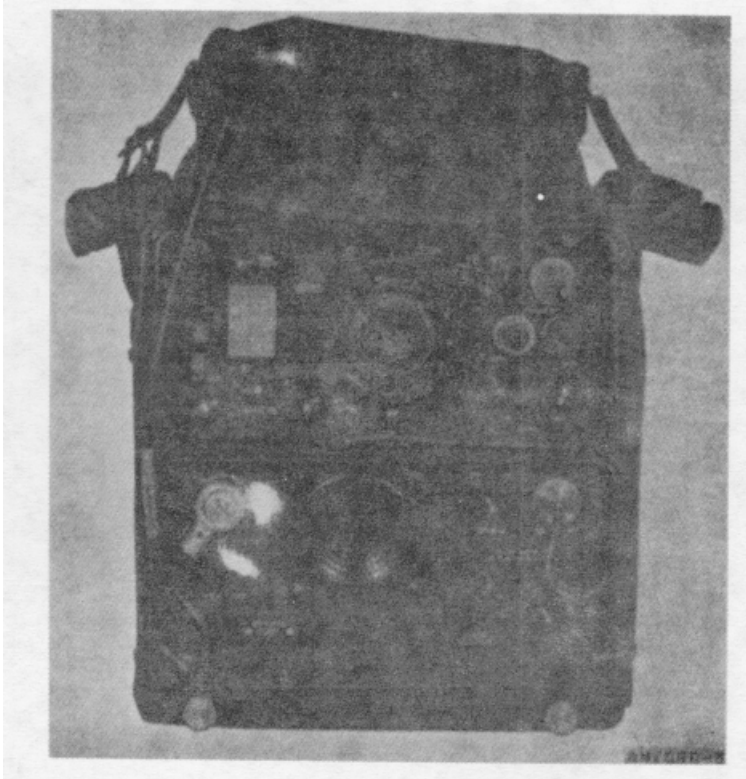

#### FUNCTIONAL DESCRIPTION:

Radio Set AN/GRR-5( ) is a low-power, am (voice, cw, and mew) radio receiving equipment that operate in the mf and hf ranges. It is a general purpose set used in infantry divisions and is intended to replace Radio Set SCR-593.

This equipment consists essentially of a superheterodyne radio receiver having an integral loud-speaker and a shock mount. It is provided with a protective canvas carrying case.

Three types of antennas (whip-type, doublet, and straight wire) and an integral power supply are included. It operates from 110-v ac power or from 6-, 12-, or 24-v storage batteries. It can be operated for about 48 hours on Battery BA-48, which can be mounted on top of the equipment.

#### RELATIONSHIP TO SIMILAR EQUIPMENT:

#### TECHNICAL DESCRIPTION:

*Frequency Range in Mc:* 1.5 to 18.0 in 4 bands.

*Type Modulation:* am.

*Type of Signal:* cw, mew, voice.

**RADIO SET  
AN/GRR-5( )**

*Power Output:* 20 to 90 mw.

*Power Requirements:*

Dry Batteries: 350 to 450 ma at 1.4 v dc, and 20 to 27 ma at 90 v dc.

or

Power Supply PP-308/URR: 5.0 amp at 6 v dc; 2.5 amp at 12 v dc; 1.75 amp at 24 v dc; or 0.5 amp at 110 v ac.

*Major Units:*

1	PP-308/URR	9 3/4" x 13" x 6 1/2"	26 lbs.
1	MT-768/URR	5 1/2" x 9 5/16" x 13 1/16"	7 lbs.
1	R-174/URR	9 3/4' x 13 1/4" x 6 1/2"	18.9 lbs.

**TUBES, CRYSTALS, TRANSISTORS:**

**REFERENCE DATA AND LITERATURE:**

TM 11-295.

MIL-R-10138.

RADIO RECEIVING SET  
AN/GRR-7

26 November 1958

Cog. Serv.: USA FSN: 5820-571-5167

USA Line Item No: 636218

	USA	USN	USAF	USMC
STATUS OR TYPE CLASS.:	Std A		A/Std	

Manufacturer:

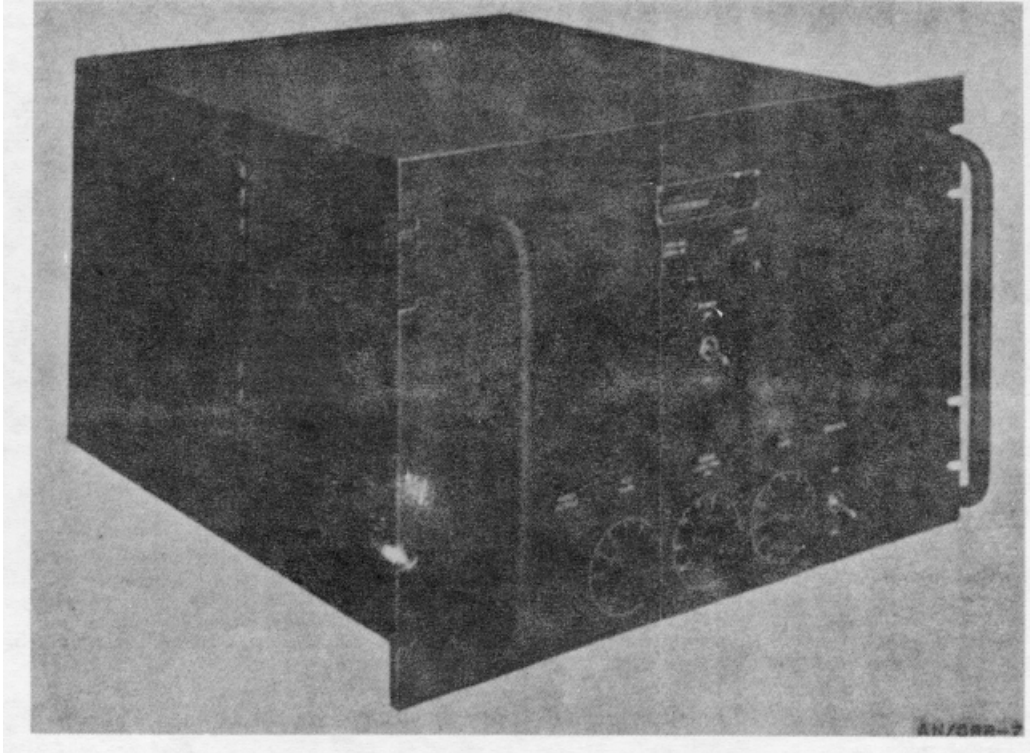
**FUNCTIONAL DESCRIPTION:**

Radio Receiving Set AN/GRR-7 is a general communication equipment used for ground operation, for air-to-ground, and point-to-point communication. Primary application is for control tower and airway station operation. It has sufficient output to operate a loudspeaker.

This equipment is a double conversion superheterodyne with a second IF of 6 megacycles. It is thus subject to interference from high frequency transmitters operating on or near this frequency.

The radio frequency input circuit is intended to operate from the following antennas: AT-197/GR, AS-505/GR, and AS450/GR. It is normally used with, but not part of, Radio Transmitter Set AN/GRT-3.

**RELATIONSHIP TO SIMILAR EQUIPMENT:****TECHNICAL DESCRIPTION:**

*Frequency Range in Mc:* 225 to 399.9.

*Spacing Between Individual Channels:* 100 kc.

*Type Control:* Crystal.



**RADIO RECEIVING SET  
AN/GRR-7**

*Type Modulation:* am.

*Type Signal:* Voice or tone.

*Power Output:* 1 w into 600-ohm load.

*Power Requirements:* 200 w, 115/230 v 60-cy 1-phase ac.

*Major Unit:* 1                      R-361/GR                      19" x 12 1/4" x 19"                      50 lbs.

**TUBES, CRYSTALS, TRANSISTORS:**

**REFERENCE DATA AND LITERATURE:**

TO AN 16-30GRR-7-1.

RADIO RECEIVER  
AN/GRR-type  
R-361C/GR

5 December 1958

Cog. Serv.: USA FSN: 5825-505-0470

USA Line Item No:

	USA	USN	USAF	USMC
STATUS OR TYPE CLASS.:			L/Std	

Manufacturer: Federal Television Corp.

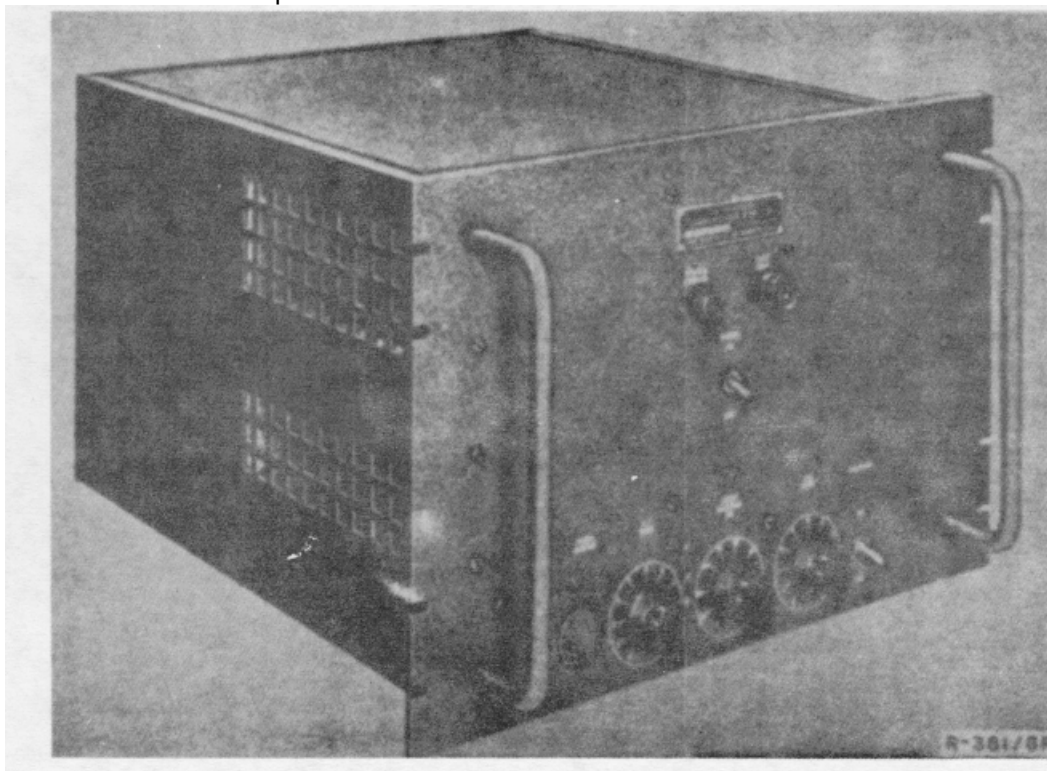

#### FUNCTIONAL DESCRIPTION:

Radio Receiver R-361C/GR is used to receive signals from equipment in aircraft beyond line-of-sight paths. The equipment operates in the frequency range of 225 to 399.9 megacycles and has an output level adequate for operating a loudspeaker of the type used in control towers.

The R-361/GR is similar to Radio Receiver R-361A/GR but has different subassemblies.

#### RELATIONSHIP TO SIMILAR EQUIPMENT:

#### TECHNICAL DESCRIPTION:

*Frequency Range in Mc:* 225 to 399.9.

*Type of Signal:* Voice or cw.

*Channel Spacing:* 100 kc.

*Output Impedance:* 600 ohms.

*Power Requirement:* 115-230 v 6cy 1-phase ac.

*Major Unit:* 1 R-361C/GR.

#### TUBES, CRYSTALS, TRANSISTORS:

#### REFERENCE DATA AND LITERATURE:

RADIO SET  
AN/GGR-type  
SCR-607-( )

1 March 1964

Cog. Serv.: USA FSN: 5820-164-7241

USA Line Item No: 654800

USA USN USAF USMC

STATUS OR TYPE CLASS.:

Manufacturer: Electronic Devices, Inc.

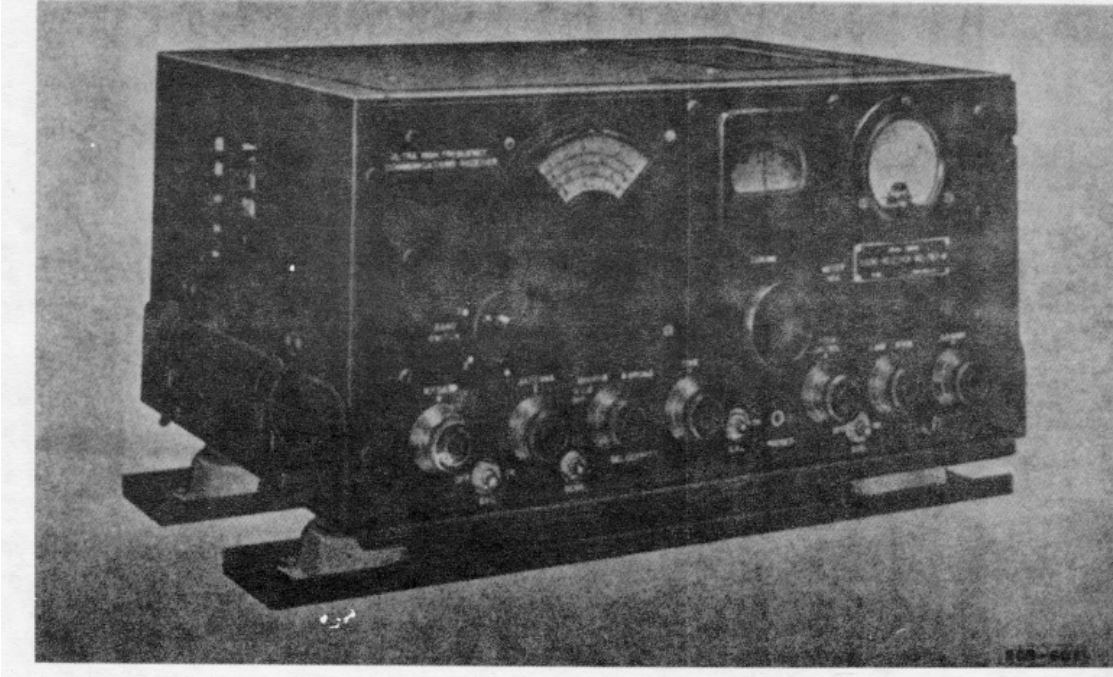

#### FUNCTIONAL DESCRIPTION:

Radio Set SCR-407-( ) is a 3-band, voice and cw, am and fm, medium- and high-frequency, general purpose radio receiving equipment for fixed station or mobile use in intercept, monitoring, or communication application.

It consists of a commercial type (Hallicrafter S-36) table model communication receiver that can also be mounted on a standard relay rack. It is designed to operate with a special dipole array (Antenna Equipment RC-154) and can be controlled at standby from a remote location by means of auxiliary equipment.

This equipment is operated from 115-230-volt ac or from a 6-volt vehicular storage battery plus 270 volts of B battery supply. A shock mount is provided for use when this set is installed and operated in a vehicle.

#### RELATIONSHIP TO SIMILAR EQUIPMENT:

**RADIO SET**  
**AN/GRR-type**  
**SCR-607-( )**

**TECHNICAL DESCRIPTION:**

*Frequency Range in Mc:* 27.8 to 143 in 3 band.

*Type Modulation:* am, fm.

*Type of Signal:* Voice, cw.

*Power Requirements:* 110 w, 115/230 v 50/60 cy-ac; or 4.5 amp at 6 v dc from storage battery, and 145 ma at 270 v dc from B battery.

*Major Units:*

1	FT-377	4 7/8" x 21 1/4" x 14 1/2"	12 lbs.
1	BC-787	9 5/16" x 21 1/4" X 14 1/2"	78 lbs.

**TUBES, CRYSTALS, TRANSISTORS:**

**REFERENCE DATA AND LITERATURE:**

TM 11-867, TM 11-261.  
MIL-R-10235.

RADIO TRANSMITTING SET  
AN/GRT-2

26 November 1958  
 Cog. Serv.: USA FSN:  
 USA Line Item No:

	USA	USN	USAF	USMC
STATUS OR TYPE CLASS.:				L/Std

Manufacturer:

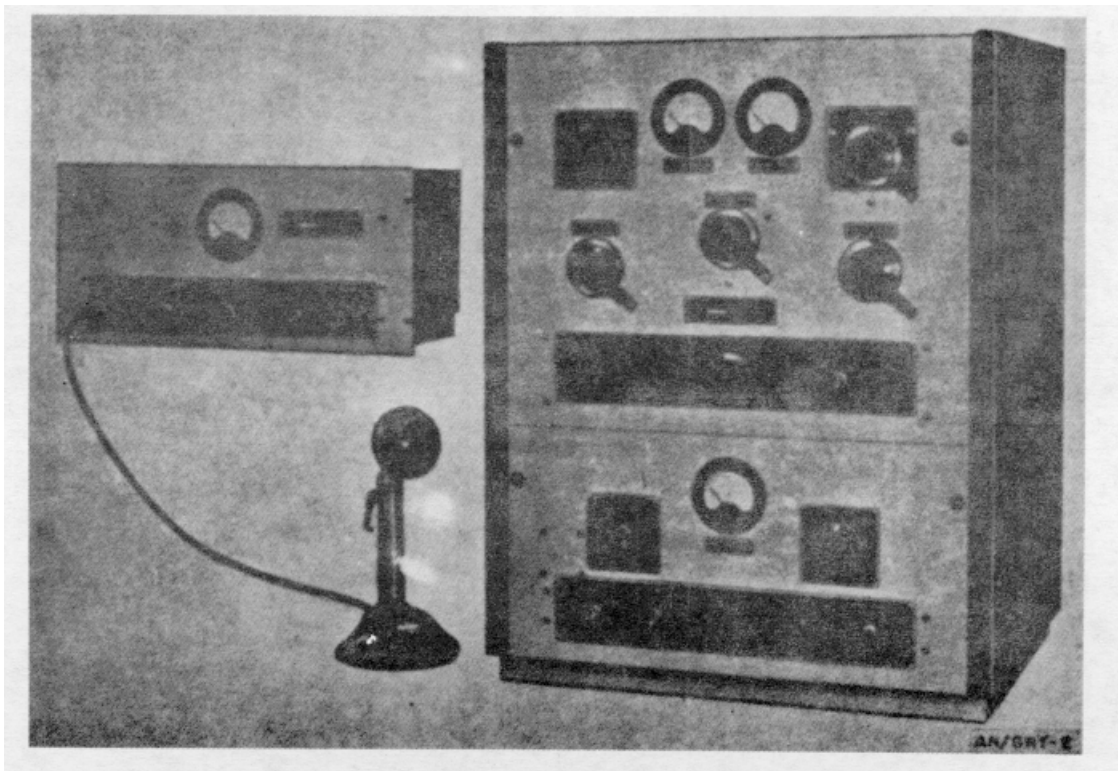
**FUNCTIONAL DESCRIPTION:**

Radio Transmitting Set AN/GRT-2 is a fixed, ground communication equipment designed for short-range airport traffic control. It can be operated from a distance of 5 miles by Remote Control Unit RM-6.

The frequency is crystal controlled, with a master oscillator for emergency operation.

The 500-ohm impedance audio input circuit is designed for a low-impedance microphone or telephone line. The antenna output is intended to operate into a long wire antenna.

**RELATIONSHIP TO SIMILAR EQUIPMENT:****TECHNICAL DESCRIPTION:**

*Frequency Range in Mc:* 0.2 to 0.41.

*Type Modulation:* am.

*Type Signal:* Voice.

*Power Output:* 25 w

**RADIO TRANSMITTING SET  
AN/GRT-2**

*Power Requirements:* 560 w 105-125 v 50-60-cy 1-phase ac; an additional 28 w is required for remote control.

*Major Units:*

1	BC-329-N	30 1/2" x 24 1/4" x 20"	240 lbs.
1	RM-6-K	8 23/32, " x 19" x 10 1/4 "	36 lbs.

**TUBES, CRYSTALS, TRANSISTORS:**

**REFERENCE DATA AND LITERATURE:**

TO 16-30FRT2-2, -3.

**RADIO TRANSMITTING SET  
AN/GRT-3**

26 November 1958  
 Cog. Serv.: USA FSN: 5820-571-5166  
 USA Line Item No: 303862

	USA	USN	USAF	USMC
<b>STATUS OR TYPE CLASS.:</b>	Std A		Std	

**Manufacturer:**

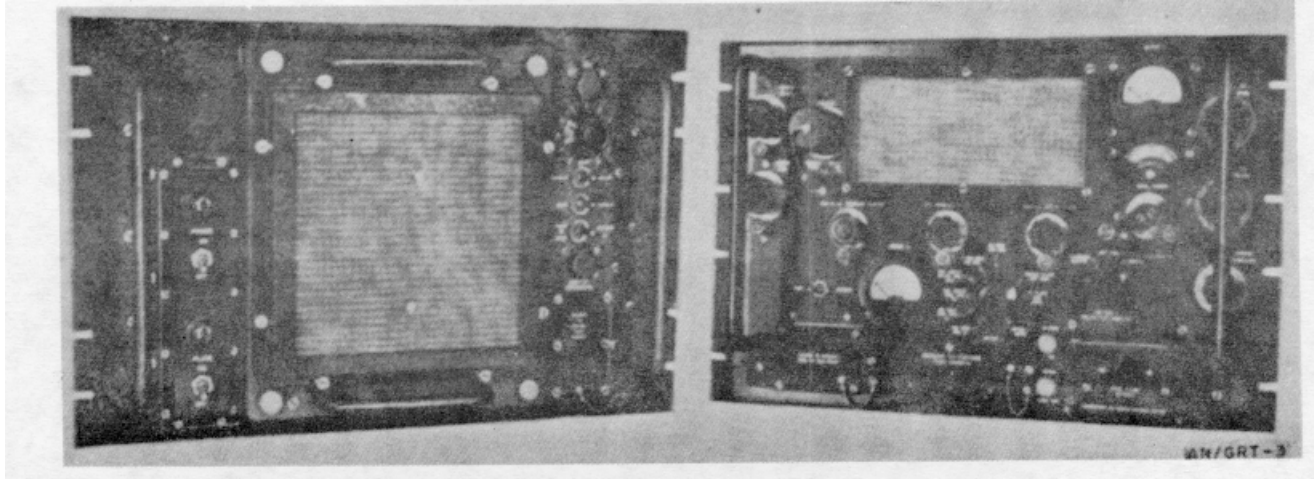

**FUNCTIONAL DESCRIPTION:**

Radio Transmitting Set AN/GRT-3 is a ground fixed station ultra-high-frequency set designed for ground-to-air and point-to-point communication. It is normally used with Radio Receiving Set AN/GRR-7 to form a two-way communication facility.

The transmitter output circuit is intended to match a 52-ohm coaxial low-impedance transmission line RG-8/U or equivalent.

Recommended antennas are: Antenna AT-197/GR, Antenna AS-505/GR, and Antenna AS-450/GR. On control tower frequencies, Antenna AT-197/GR is used. On airway frequencies, Antenna AS-505/GR is recommended. No remote control facilities are provided.

**RELATIONSHIP TO SIMILAR EQUIPMENT:**

**TECHNICAL DESCRIPTION:**

- Frequency Range in Mc:* 225 to 400.
- Type Control:* Crystal.
- Type Modulation:* am.
- Type Signal:* Voice.
- Power Output:* 100 w (nominal).
- Power Requirements:* 750 w, 105-125/210-250 v 60-cy 1-phase ac.
- Major Units:*

1	MD-141/GR	10" x 12 1/4" x 21"	200.0 lbs.
1	T-282/GR	19" x 12 1/4" x 21"	175.0 lbs.

**TUBES, CRYSTALS, TRANSISTORS:**

**REFERENCE DATA AND LITERATURE:**

**RADIO TRANSMITTER**  
**AN/GRT-type**  
**BC-610-( )**

1 March 1964

Cog. Serv.: USA FSN: 5820-189-7042

USA Line Item No: 657400

	USA	USN	USAF	USMC
<b>STATUS OR TYPE CLASS.:</b>	Obs		L/Std	

**Manufacturer:** The Hallicrafter Co.

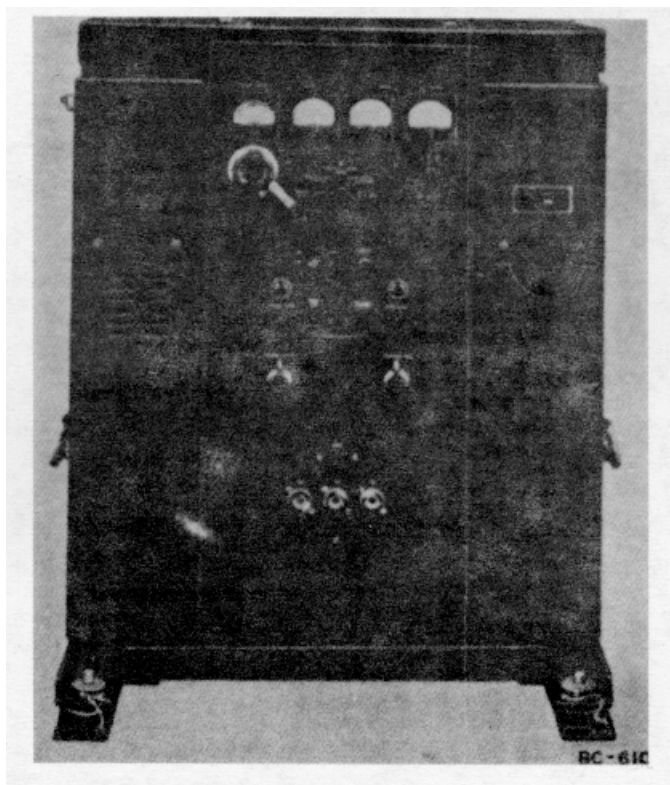

**FUNCTIONAL DESCRIPTION:**

Radio Transmitter BC-610-( ) is the widely used radio transmitting component of such equipments as Radio Sets SCR-399, SCR-499, and similar unite. It is a crystal-controlled or master oscillator medium- and high-frequency, radiotelegraph equipment used in intermediate and long-distance communication.

With additional equipment (such as Speech Amplifier BC-614-( )), this transmitter can furnish AM radiotelephone service.

This equipment consists essentially of a single, cabinet-inclosed, compact unit fitted with shock mountings. It is designed for mobile applications, using whip-type antenna systems. With rhombic, doublet, tower-supported or other elaborate antenna arrays, it can be used as a fixed station transmitter.

As mobile equipment it is powered by a trailer-drawn power unit; as fixed station equipment it is operated on conventional power sources.

**RELATING TO SIMILAR EQUIPMENT:**



**RADIO TRANSMITTER**  
**AN/GRT-type**  
**BC-610 ( )**

**TECHNICAL DESCRIPTION:**

*Frequency Range in Mc:* 2 to 18.

*Type Modulation:* AM.

*Type of Signal:* cw or voice (with additional equipment).

*Power Output:*

Cw: 400 w.

Voice: 300 w.

(Above 8 mc, the output is somewhat less.)

*Power Requirements:* 1,700 to 2,000 w, 115 v 50/60y sc.

*Major Unit:* 1 BC-610

32 5/8" x 21 3/8" x 39 7/8"

497 lbs.

**TUBES, CRYSTALS, TRANSISTORS:**

**REFERENCE DATA AND LITERATURE:**

TM 11-281, TM 11-826.

71-3334-610-1).

71-1683-( ).

**RADIO TRANSMITTER**  
**AN/GRT-type**  
**T-417/GR**

1 March 1964

Cog. Serv.: USA FSN: 5820-503-3305

USA Line Item No: 691-961

	USA	USN	USAF	USMC
<b>STATUS OR TYPE CLASS.:</b>	Std A			

**Manufacturer:** The Hallicrafters Co.

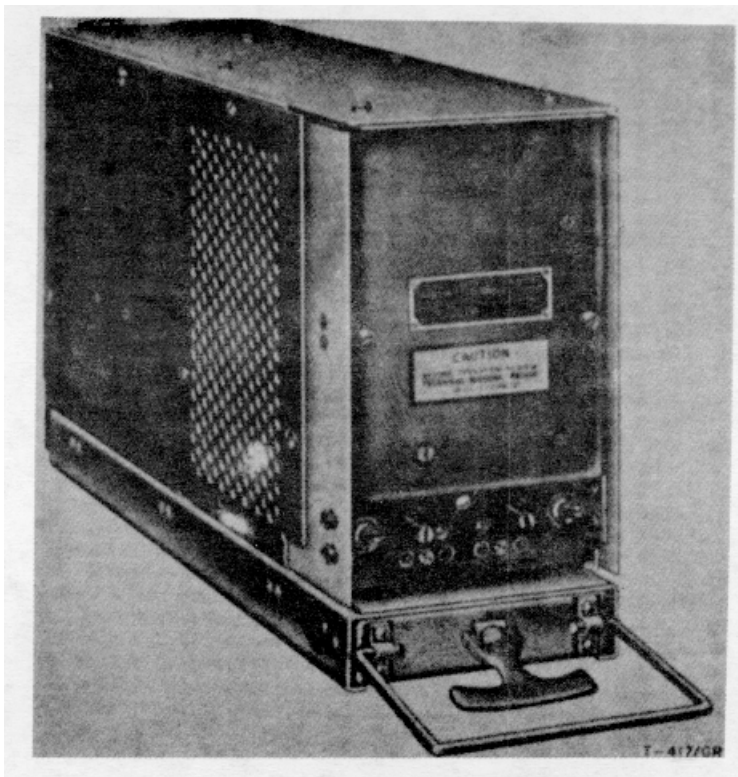

**FUNCTIONAL DESCRIPTION:**

Radio Transmitter T417/GR is an fm radio transmitter deigned for fixed station use. It is intended for use in system applications to provide point-to-point communication, or radio relay service by retransmission.

This transmitter is not self-sufficient; it relies on other components of the system to provide power and control facilities.

Provision is made for operation on either of two preset crystal-controlled frequencies.

It is used as part of Radio Sets AN/FRC-15 and AN/TRC-22.

**RELATIONSHIP TO SIMILAR EQUIPMENT:**

**TECHNICAL DESCRIPTION:**

*Frequency Range in Mc:* 25 to 50.

*Type Modulation:* fm.

**RADIO TRANSMITTER**

**AN/GRT-type  
T-417/GR**

*Type of Signal:* Voice.

*Power Output:* 45 w.

*Power Requirements:* Pwr Supply PP-804/U or equiv (not supplied as part of this equipment).

*Major Unit:* 1 T-417/GR 8 1/2" x 4 1/2" x 14 1/2"

**TUBES, CRYSTALS, TRANSISTORS:**

**REFERENCE DATA AND LITERATURE:**

TM 11-804.

MIL N-11539.

**CODE TRAINING SET  
AN/GSC-T1( )**

1 March 1964

Cog. Serv.: USA FSN: 6940-243-1972

USA Line Item No: 610970

	USA	USN	USAF	USMC
<b>STATUS OR TYPE CLASS.:</b>	Std A		L/Std	

**Manufacturer:**

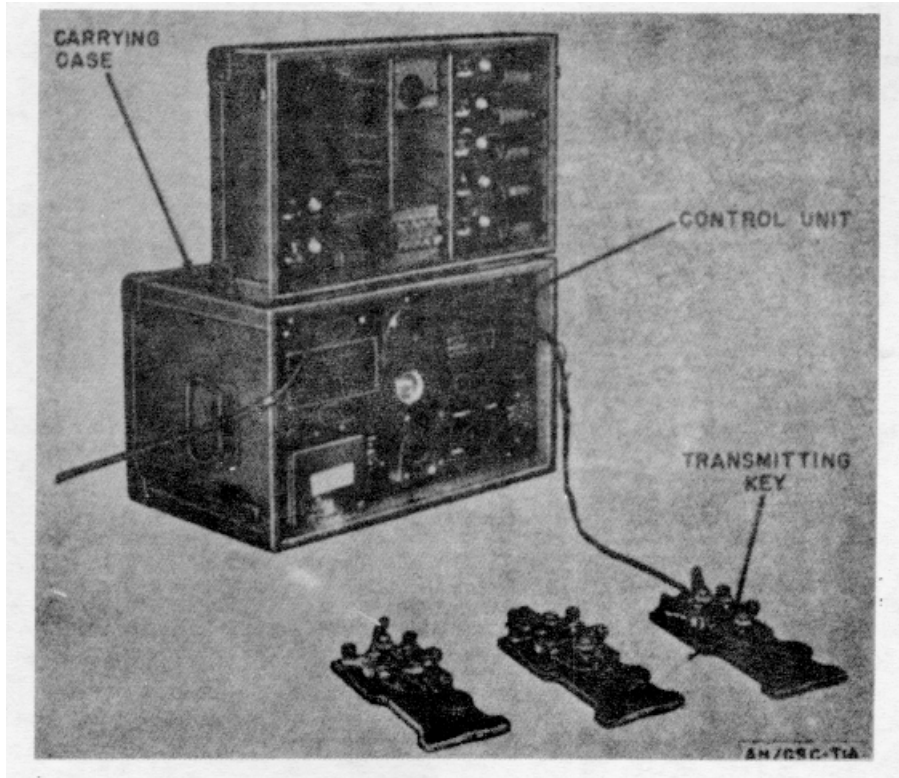

**FUNCTIONAL DESCRIPTION:**

Code Training Set AN/GSC-T1( ) is a device intended to facilitate student practice of transmission and reception of International Morse Code signals by both visual and audio methods.

This equipment is used at camps, aboard transports, in hospitals, and in rehabilitation centers. It may be operated out of doors.

Practice groups may be placed as far as 40 feet from the equipment, provided the surrounding noise levels do not exceed 60 decibels. It includes 10 telegraph keys which may all be connected to the main unit at one time.

During operation, hand keying produces either an audio tone adjustable in pitch and volume, or a blinker flash visible to a practice group. The tone is delivered by a loudspeaker and the blinker flash by a 1-watt neon gas lamp.

There are two models of this equipment, Code Training Sets AN/GSC-T1 and AN/GSC-T1A. Both of these items are functionally similar, and differ only in minor electrical details.

**RELATIONSHIP TO SIMILAR EQUIPMENT:**

**CODE TRAINING SET  
AN/GSC-T1( )**

**TECHNICAL DESCRIPTION:**

*Medium of Communication:*

Audible: 2 1/2" permanent magnet loudspeaker.

Visual: 1 w neon gas lamp.

*Frequency of Tone:* 600 to 1, 000 cps  $\pm$ 20%.

*Sound Range:* Approximately 40 ft; with local noise below 60 db noise level.

*Pour Requirements:* 6/12/24/115-v dc; or 115/230-v 60-cy ac.

*Major Unit:* 1 AN/GSC-T1 ( ) 13 1/4" x 18" x 11"

52.0 lbs.

**TUBES, CRYSTALS, TRANSISTORS:**

**REFERENCE DATA AND LITERATURE:**

TM 11-437; TM 11-437A; TO 28-30GSCT1-6.  
MIL-T-13660.

RADIO TRANSMITTING SET  
AN/GTA-type  
AN/GRT-2

26 November 1958  
Cog. Serv.: USA FSN:  
USA Line Item No:

	USA	USN	USAF	USMC
STATUS OR TYPE CLASS.:				L/Std

Manufacturer:

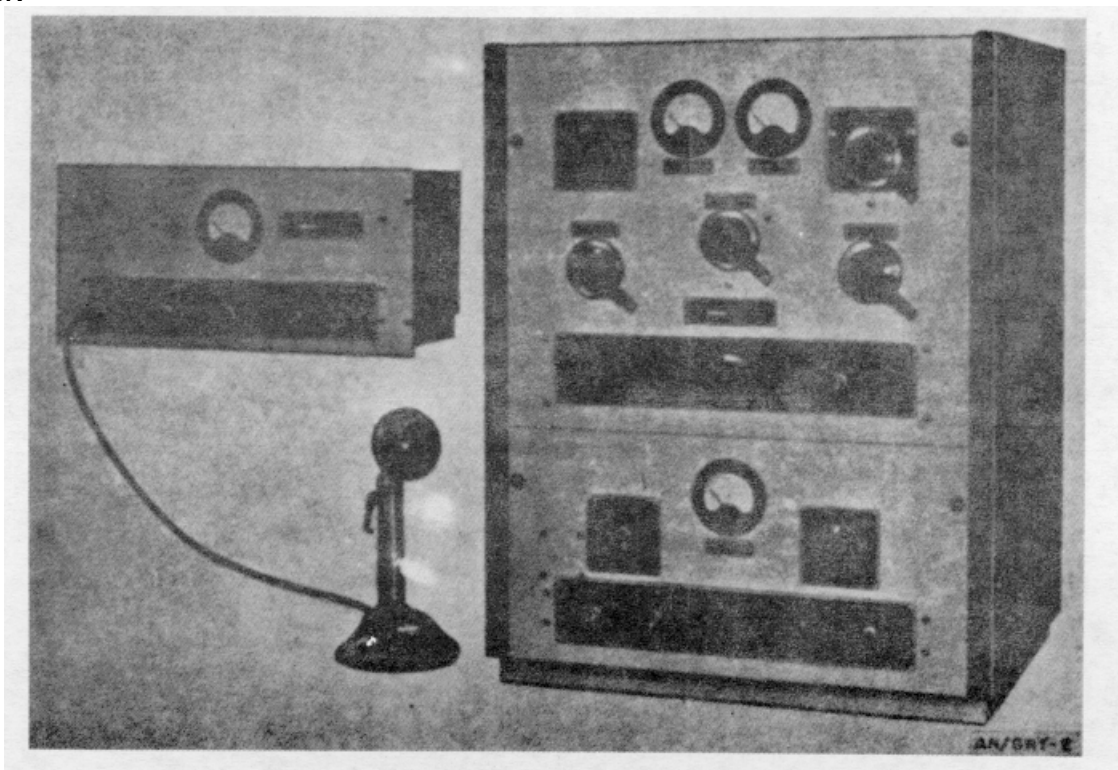

**FUNCTIONAL DESCRIPTION:**

Radio Transmitting Set AN/GRT-2 is a fixed, ground communication equipment designed for short-range airport traffic control. It can be operated from a distance of 5 miles by Remote Control Unit RM-6.

The frequency is crystal controlled, with a master oscillator for emergency operation.

The 500-ohm impedance audio input circuit is designed for a low-impedance microphone or telephone line. The antenna output is intended to operate into a long wire antenna.

**RELATIONSHIP TO SIMILAR EQUIPMENT:**

**TECHNICAL DESCRIPTION:**

*Frequency Range in Mc:* 0.2 to 0.41.

*Type Modulation:* am.

*Type Signal:* Voice.

*Power Output:* 25 w

**TELEPHONE REPEATER**  
**AN/GTA-type**  
**TA-126/GT**

*Frequency:* 200 to 6, 500 cpe.

*Power Requirements:* 1 amp 115-v (+ 10%) 50/60-cy ac; 4 amp 22-30-v dc.

*Major Unit:* 1 TA-126/GT

11 5/8" x 15 7/8" x 16 1/2"

65 lbs.

**TUBES, CRYSTALS, TRANSISTORS:**

**REFERENCE DATA AND LITERATURE:**

TM 11-2135.

MIL-T-11004.

**TELEPHONE REPEATER**  
**AN/GTC-type**  
**TP-14**

1 March 1964

Cog. Serv.: USA FSN: 5805-164-7065

USA Line Item No: 678180

	USA	USN	USAF	USMC
<b>STATUS OR TYPE CLASS.:</b>	Std A			

**Manufacturer:** General Development Corp.

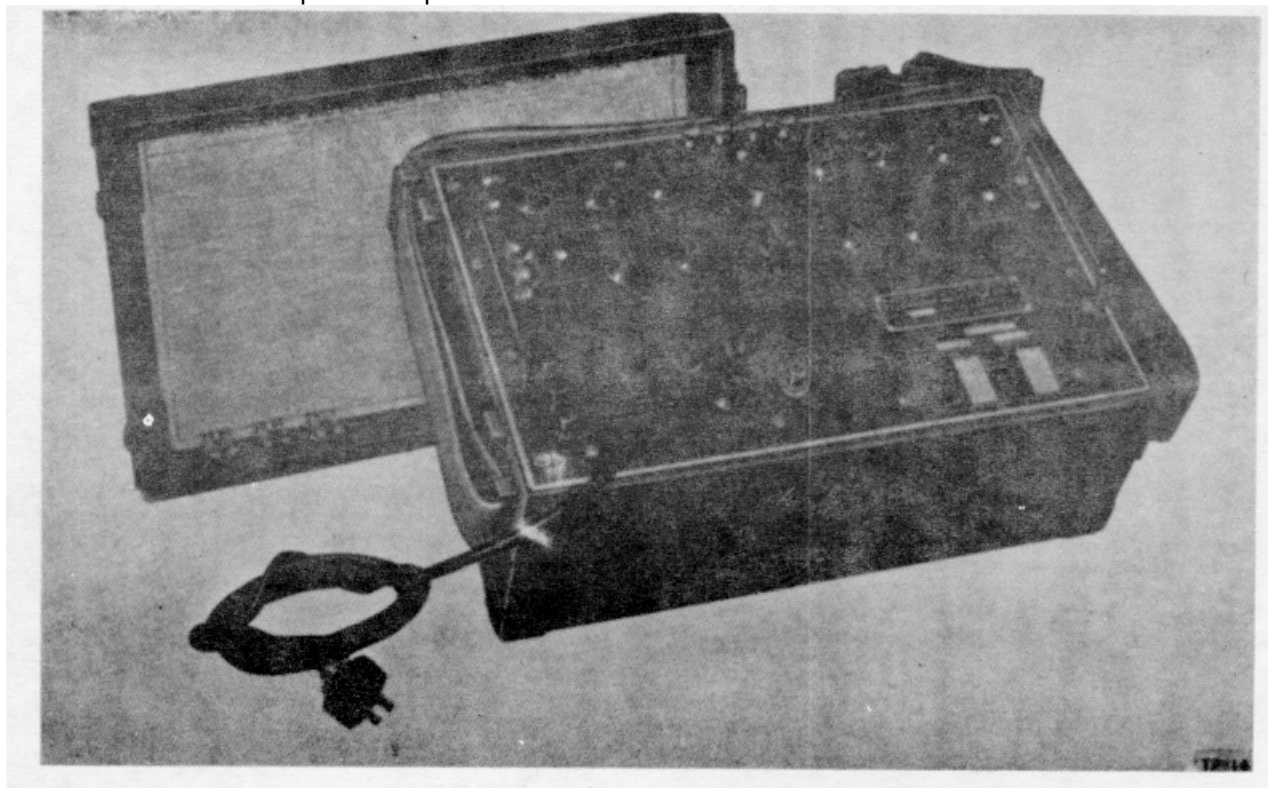

**FUNCTIONAL DESCRIPTION:**

Telephone Repeater TP-14 is a portable, field, 22-type repeater equipment used to extend the range of two-wire (open-wire or field cable) facilities.

This equipment consists of a completely self-contained unit including the amplifier, filters, equalizers, line-balancing networks, and related items. It is a panel-mounted apparatus contained in a protective box or case, and can be removed from its housing for rack-and-panel mounting in fixed-station applications.

Two of these repeaters may be used in tandem to extend circuits where mixed facilities, such as open-wire and field cable, are used, and can be installed at terminal or intermediate points of a system.

**RELATIONSHIP TO SIMILAR EQUIPMENT:**

**TECHNICAL DESCRIPTION:**

*Number and Type of Facilities:* Four-wire to four-wire amplification or two-wire to four-wire amplification or four-wire to two-wire amplification.



**TELEPHONE REPEATER**  
**AN/GTC-type**  
**TP-14**

*Power Requirements:* 11 w 110-130/220-250-v 50/60-cy ac; or 800 ma at 12-v dc from storage battery; or 20 ma at 135-v dc from dry cells and 150 ma at 12-v dc from storage battery.

*Major Unit:*

1 TP-14

17 1/2" x 11" x 8".

**TUBES, CRYSTALS, TRANSISTORS:**

**REFERENCE DATA AND LITERATURE:**

TM 11-2007.

MIL-R-13215B.

**TONE WARNING GENERATOR GROUP**  
**AN/GTT-type**  
**OA-145/GT**

1 March 1964

Cog. Serv.: USA FSN:

USA Line Item No: 687310

---

**STATUS OR TYPE CLASS.:**

<b>USA</b>	<b>USN</b>	<b>USAF</b>	<b>USMC</b>
------------	------------	-------------	-------------

Std A

---

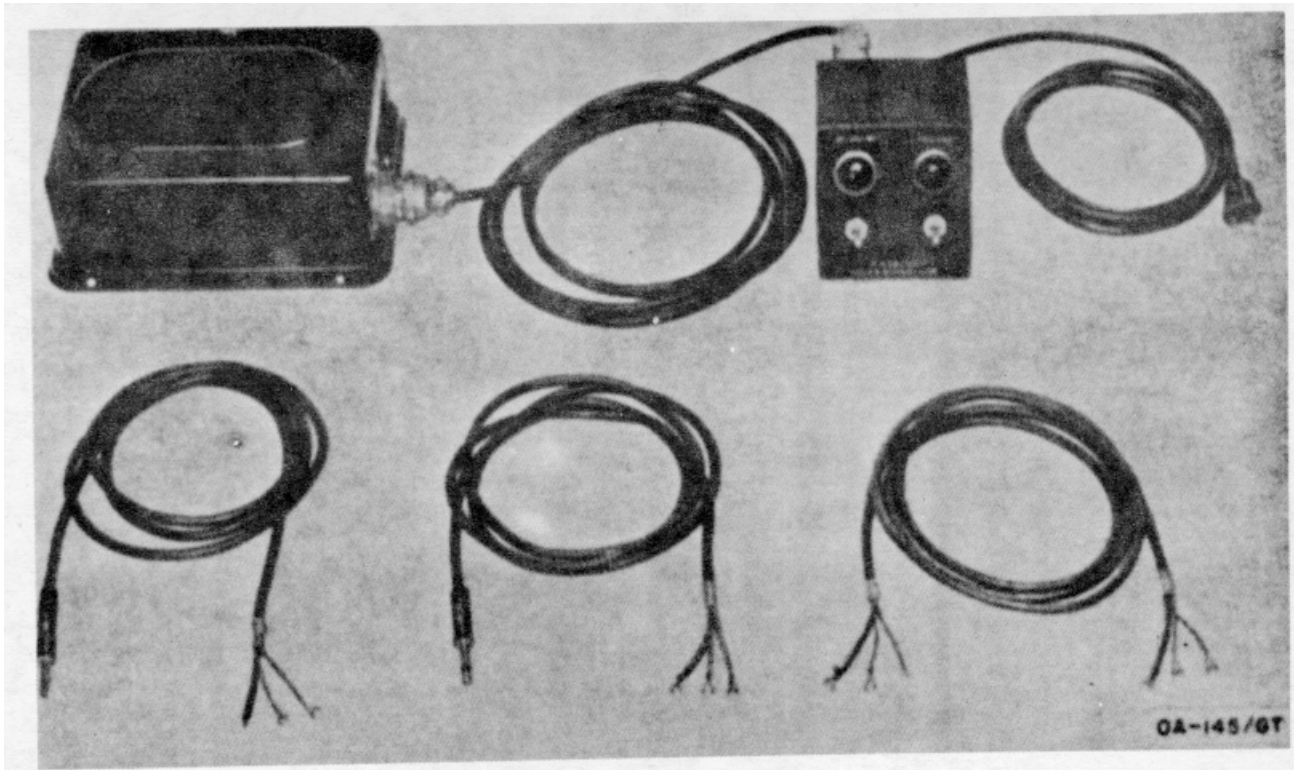
**Manufacturer:**
**FUNCTIONAL DESCRIPTION:**

Tone Warning Generator Group OA-145/GT is used on telephone lines to give audible indication that the telephone conversation is being recorded.

This equipment consists essentially of a tone-warning generator, controls, and accessories.

Three special purpose cable assemblies are supplied with this equipment for flexibility in connection to most standard recorders.

The warning signal is applied to the line at intervals of 15 seconds, which complies with the requirements of the Federal Communication Commission for use on commercial telephone lines.

**RELATIONSHIP TO SIMILAR EQUIPMENT:****TECHNICAL DESCRIPTION:**

*Type of Signal:* 1,400-cps tone of 0.2 second duration, 15 second interval.

*Power Requirements:* 115-v 50/60cy ac.

**TONE WARNING GENERATOR GROUP**  
**AN/GTT-type**  
**OA-145/GT**

*Major Units:*

1	C-38/GT	31 15/16" x 4" x 4 1/2"	0.5 lbs.
1	O-93/GT	9 3/4" x 6 5/8" x 4 1/32"	1.5 lbs.

**TUBES, CRYSTALS, TRANSISTORS:**

**REFERENCE DATA AND LITERATURE:**

TM 11-2088.  
(USA)71-3370 and 71-3412.

RADIO SET  
AN/MRC-2( )

1 March 1964

Cog. Serv.: USA FSN: 5820-193-7188

USA Line Item No: 641800

	USA	USN	USAF	USMC
STATUS OR TYPE CLASS.:	Std B			

Manufacturer: Baker & Williamson, Inc.

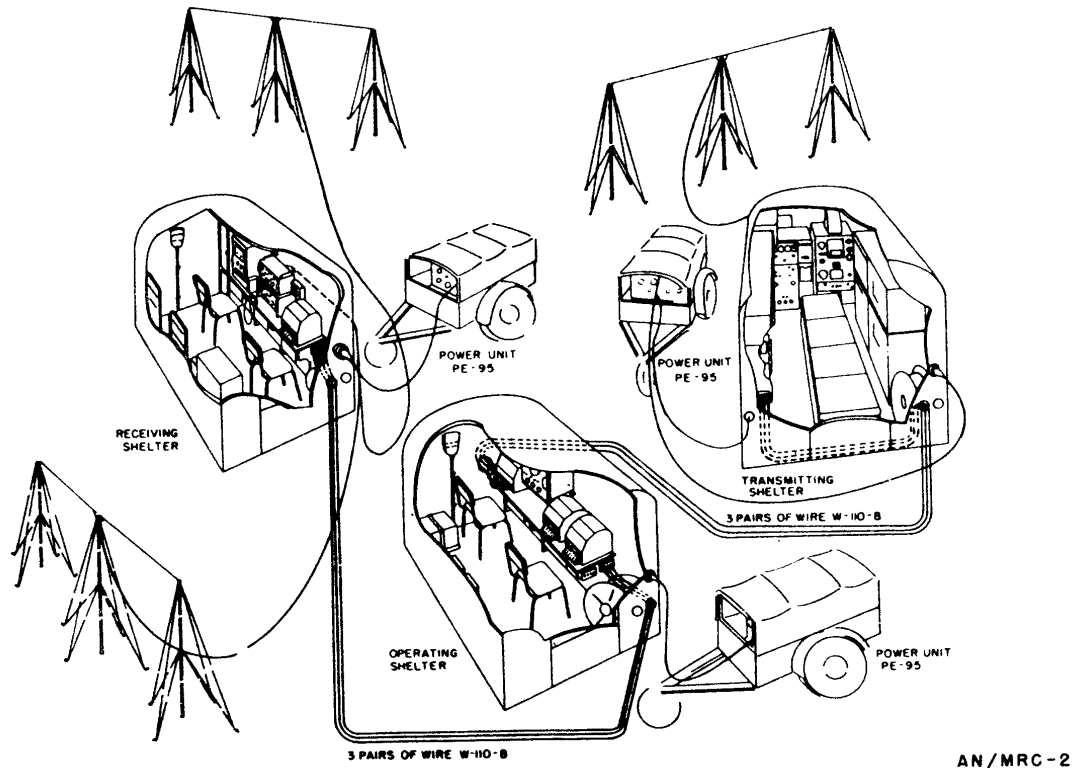

#### FUNCTIONAL DESCRIPTION:

Radio Set AN/MRC-2( ) is a 2-kw mobile radioteletype station designed to provide either net or long-distance operation, with provision for fsk radioteletype communication. It is used at field headquarters large units for long-range communication and for handling a heavy volume of traffic.

This equipment is installed and operated in three Shelters HO-17, each carried on a 2 1/2 ton, 6 x 6 cargo truck. Each truck has a 6-kw trailer-drawn power unit. One shelter houses the transmitting equipment, another carries the receiving equipment, and the third carries the teletypewriter equipment. An additional truck may be provided to transport the antenna masts and accessories.

The transmitter operates into one coaxially-fed doublet antenna. The receiver operated with two, coaxially-fed doublet antennas spaced three wavelengths apart for diversity reception.

In addition to fsk radioteletype, it is possible to transmit cw at 2 kw, and voice or cw at 300 w o 400 w, respectively.

#### RELATIONSHIP TO SIMILAR EQUIPMENT:

**RADIO SET  
AN/MRC-2( )**

**TECHNICAL DESCRIPTION:**

*Frequency Range in Mc:*

Transmitter: 2 to 18.

Receiver: 1.5 to 18 in 6 bands.

*Type Modulation:* am.

*Type of Signal:* fsk radioteletype, cw, voice.

*Power Output:*

Voice: 300 w.

Fsk or cw: 2 kw 400 w.

*Power Requirements:*

Transmitter: 6.5 kw 115-v 60-cy ac.

Receiver: 2.5 kw 115-v 60-cy ac.

Operating: 2 kw 115-v 60-cy ac.

*Major Units:*

1 PE75

56" x 44" x 39"

491 lbs.

3 PE-9

76 1/2" x 108" x 76 1/2"

4,965 lbs.

1 ea HO-17, Operating, Receiving, Transmitting.

158" x 90 1/2" x 77"

7,200 lbs.

**TUBES, CRYSTALS, TRANSISTORS:**

**REFERENCE DATA AND LITERATURE:**

TM 11-624.

TO 16-30MRC2-7.

**RADIO SET  
AN/MRC-5, AN/MRC-5C**

15 March 1962

Cog. Serv.: USA FSN: 5820-669-7026 (AN/MRC-5)  
5820-501-3754(AN/MRC-5C)

USA Line Item No:

USA	USN	USAF	USMC
-----	-----	------	------

---

**STATUS OR TYPE CLASS.:**

---

Manufacturer: (74423).

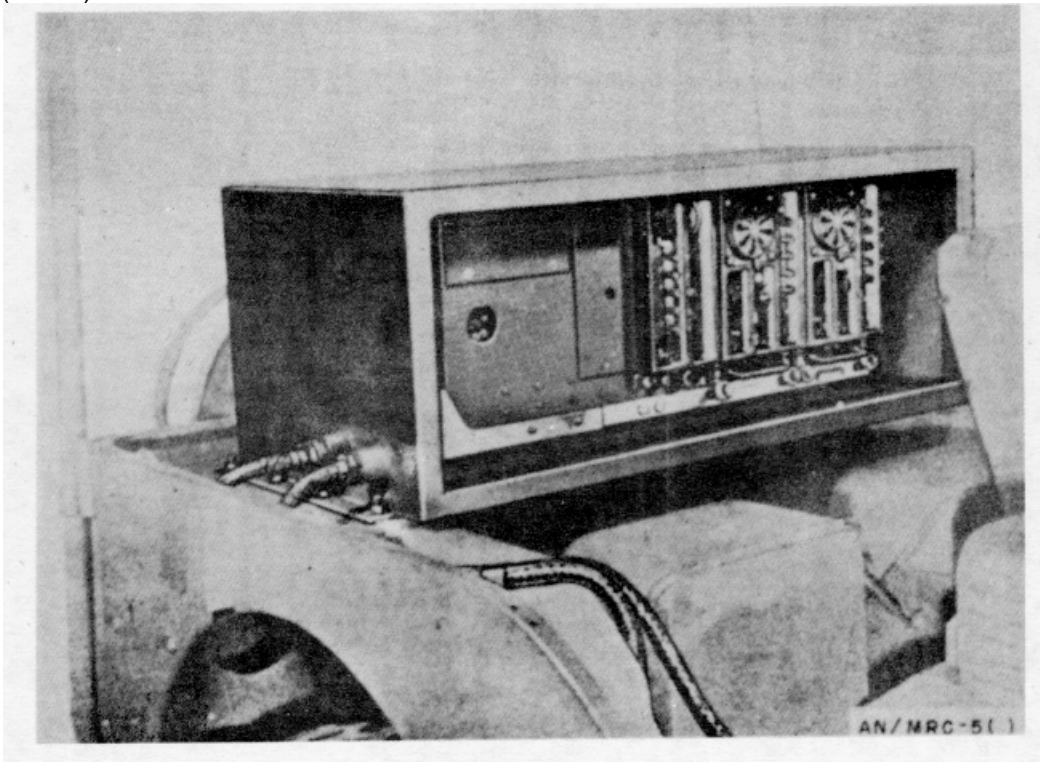
**FUNCTIONAL DESCRIPTION:**

Radio Sets AN/MRC-5 and AN/MRC-5C are complete mobile radio stations for short-range ground communications in field and internal security operations. Either radio set consists of Radio Set SCR-608 installed in a type M-38 quarter-ton jeep. Headset reception and push-to-talk transmission are possible at the local radio-set control (located between the seats or on the dashboard of the vehicle) and at the remote radio-set control, which may be located up to a distance of one mile from the vehicle. The local radio-set control provides loudspeaker reception and on-off power control of the radio set. The equipment is submersible.

The difference between models results from the use of a 12-vdc power supply for Radio Set AN/MRC-5 and a 24-vdc power supply for Radio Set AN/MRC-5C.

**RELATIONSHIP TO SIMILAR EQUIPMENT:**

Radio Sets AN/MRC-5 and AN/MRC-5C are functionally similar to Radio Set AN/MRC-5B; the latter differs in type of vehicle used and in mounting details.

**RADIO SET**  
**AN/MRC-5, AN/MRC-5C**

**TECHNICAL DESCRIPTION:**

*Frequency Range:* 27.0 to 38.9 mc; receiving and transmitting.

*Transmitter Data:*

- Frequency Control: Crystal.
- Number of Channels: 10 preset.
- Emission: F3.
- Power Output: 20 w.

*Receiver Data:*

- Type: Superheterodyne.
- Frequency Control: 10 preset or continuous manual tuning.
- Reception: F3.
- Intermediate Frequency: 2.65 mc.
- Bandwidth: 80 kc.
- Sensitivity: 1  $\mu$ v.
- Audio Output: 2 w to loudspeaker; 0.2 w to headset.

*Range of Communication:* 5 to 15 miles.

*Antenna:* 10-foot whip.

*Major Units:*

1	M-38	62" x 74" x 133"	2,401 lbs.
1	CY-731A/MRC	17" x 18 11/16" X 44 5/8"	86 lbs.
1	C-1217/MRC	7" x 10 5/8" X 8 3/4"	14 lbs.
1	C-1226/MRC	1 9/16" x 3 3/16" x 4 7/8"	1.2 lbs.
1	SCR-08	13 1/8" x 13 9/32" x 35 5/8"	181 lbs.

**TUBES, CRYSTALS, TRANSISTORS:**

**REFERENCE DATA AND LITERATURE:**

NAVSHIPS 91811.

**RADIO SET  
AN/MRC-5B, 6B, 7B, 8B**

15 March 1962

Cog. Serv.: USA FSN:

USA Line Item No: 611025

---

**USA    USN    USAF    USMC**

---

**STATUS OR TYPE CLASS.:**

---

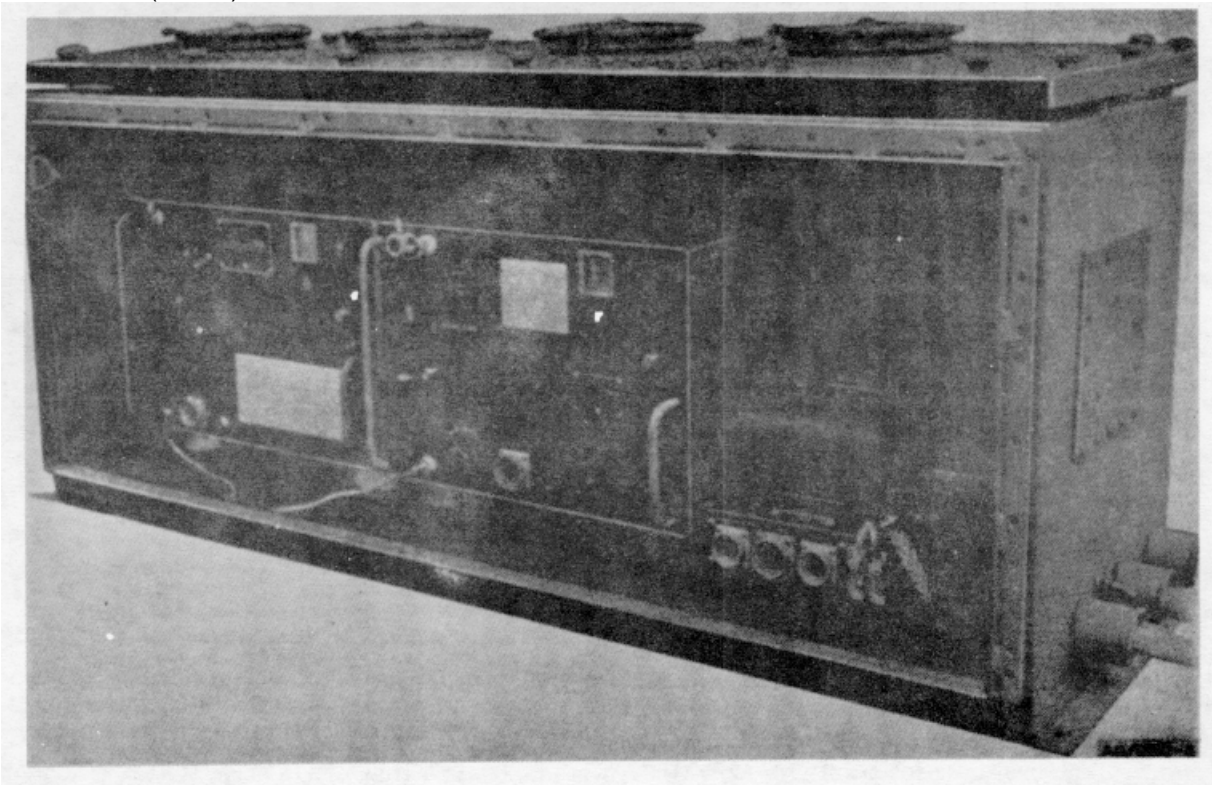
**Manufacturer:** CVD (65909)**FUNCTIONAL DESCRIPTION:**

Radio Sets AN/MRC-5B, 6B, 7B, and 8B provide mobile radio stations for short range communications systems such as those used for internal security operations.

**RELATIONSHIP TO SIMILAR EQUIPMENT:**

Each radio set is designed to operate after brief periods of submersion. Each radio set consists of a receiver-transmitter assembly, a quarter-ton 4x4 Universal jeep, a power supply kit, an installation kit, and two 6-volt storage batteries equipped with special underwater vent caps.

These sets are identical to each other in type of vehicle used and power source requirements, differing only in the type of receiver-transmitter used.



**RADIO SET**  
**AN/MRC-5B, 6B, 7B, 8B**

**TECHNICAL DESCRIPTION:**

*Transmitter-Receiver Assembly OA-25A/MRC-5:*

Frequency Range: 27.0 to 38.9 mc.  
 Channel Spacing: 100 kc increments.  
 Number of Channels: 120.  
 Channel Numbers: 270 to 389 inclusive.  
 Number of Preset Channels: 10.  
 Communication Range: 5 to 15 miles.  
 Operating Power Requirements: 12 vdc.  
 Operation: Local or remote.  
 Control of Channels: Local only.

*Transmitter-Assembly OA-A/MRC-6:*

Frequency Range: 1.5 to 12 mc in three bands.  
 Band Coverage:  
 Band 1: 1.5 to 3 mc.  
 Band 2: 3 to 6 mc.  
 Band 3: 6 to 12 mc.  
 Operating Power Requirements: 12 vdc.  
 Operation: Local or remote.  
 Control of Bands: Local only.

*Transmitter-Receiver Assembly OA-41A/MRC-7:*

Frequency Range: 20.0 to 27.9 mc.  
 Channel Spacing: 100 kc increments.  
 Number of Channels: 80.  
 Channel Numbers: 0 to 79 inclusive.  
 Number of Preset Channels: 10.  
 Communication Range: 10 miles (approximately).  
 Operating Power Requirements: 12 vdc.  
 Operation: Local or remote.  
 Control of Channels: Local only.

*Transmitter-Receiver Assembly OA-42A/MRC-8:*

(Technical description of OA-42A/MRC-8 is identical to that of OA-41A/MRC-7).

*Major Units:*

1 Truck V-35/U:	68" x 60 5/8" x 134 1/4"	2,726 lbs.
For AN/MRC-5B:		
1 OA-26A/MRC-5.		
For AN/MRC-6B:		
1 OA-27A/MRC-6.		
For AN/MRC-7B:		
1 OA-41A/MRC-7.		
For AN/MRC-8B:		
1 OA42A/MRC-8.		

**TUBES, CRYSTALS, TRANSISTORS:**

**REFERENCE DATA AND LITERATURE:**

NAVSHIPS 91398.

**RADIO SET  
AN/MRC-6C**

15 March 1962

Cog. Serv.: USA FSN: 5820-  
642-9788

USA Line Item No:

USA    USN    USAF    USMC

STATUS OR TYPE CLASS.:

Manufacturer: CBGR (74423).

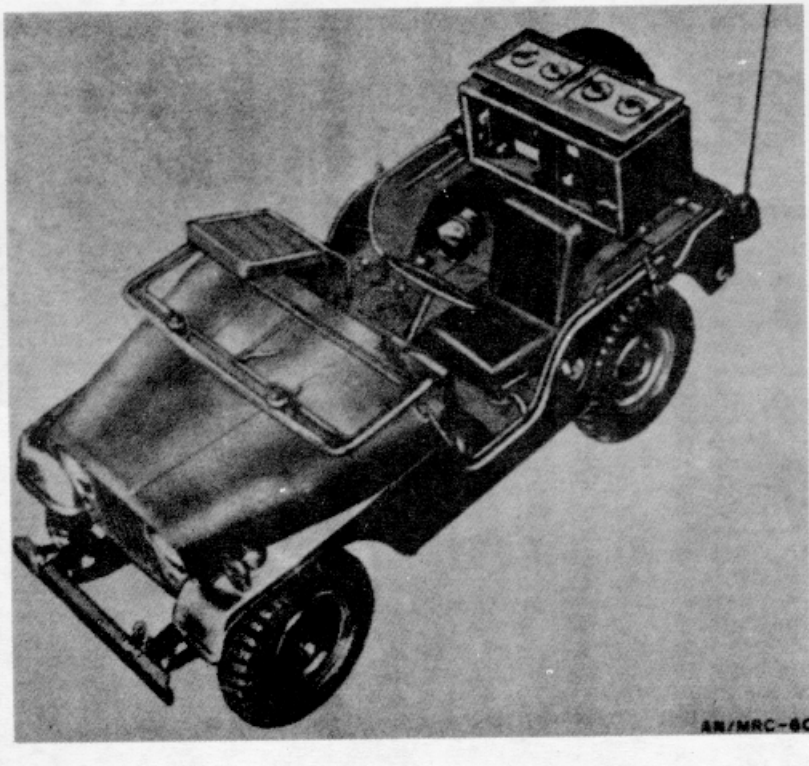

#### FUNCTIONAL DESCRIPTION:

Radio Set AN/MRC-6C is a complete vehicular radio station for short range, ground-to-ground tactical field use. The equipment may be operated after it has been submerged during deep water fording or landing operations.

Transmission and reception on a predetermined frequency may be carried on from the Dash-Remote control position in the AN/MRC-6C, and from either the local radio set control located between the seats of the vehicle, or from the remote radio set control which may be located at any distance up to a mile from the vehicle.

#### RELATIONSHIP TO SIMILAR EQUIPMENT:

Radio Set AN/MRC-6C is functionally similar to Radio Set AN/MRC-6B; the latter differs in type of vehicle used and in mounting details.

**RADIO SET  
AN/MRC-6C**

**TECHNICAL DESCRIPTION:**

*Frequency Range:* 1500 to 12000 kc.

*Emission:* A1, A3.

*Power Output:* A1: 25 w.

A3: 10 w.

*Frequency Control:* Crystal or Master Oscillator.

*Special Features:* Waterproof Case.

*Major Units:*

1	M39A1	60 7/8" x 73 3/4" x 138 5/8"	2665	lbs.
1	CY-731A/MRC	17" x 18 11/16" x 44 5/8"	86	lbs.
1	C-1217/MRC	7 1/4" x 8 3/4" x 10 5/8"	14	lbs.
1	C-1228/MRC	1 9/16" x 3 3/16" x 4 7/8"	1.2	lbs.
1	Radio Transmitter 52245A	11" x 11 13/16" x 13 3/4"	48	lbs.
1	Radio Receiver NT-46159A	11 1/16" x 11 7/8" x 13 16/16"	38.1	lbs.
1	Dynamotor Power Unit NT-211330B	8 25/32" x 5 5/8" x 12 15/16"	35	lbs.

**TUBES, CRYSTALS, TRANSISTORS:**

**REFERENCE DATA AND LITERATURE:**

NAVSHIPS 91811.

RADIO SET  
AN/MRC-20

24 November 1958

Cog. Serv.: USA FSN: 5820-505-1942

USA Line Item No: 642200

	USA	USN	USAF	USMC
STATUS OR TYPE CLASS.:			L/Std	

Manufacturer: Northeastern Engineering, Inc.

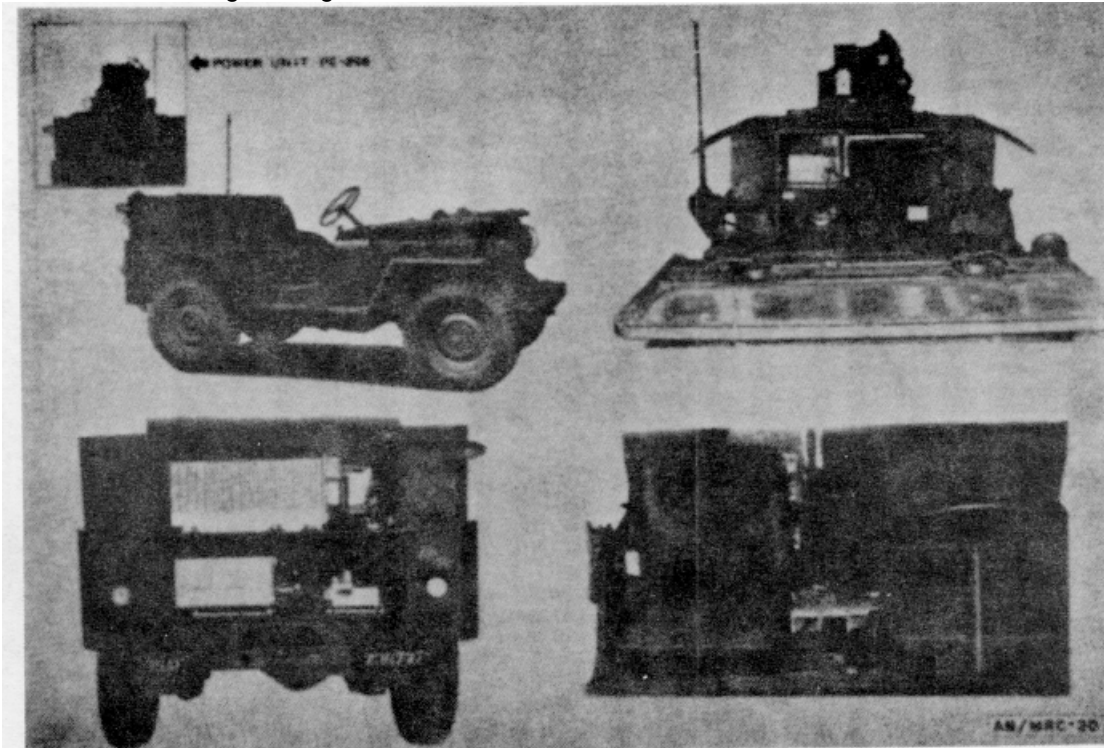
**FUNCTIONAL DESCRIPTION:**

Radio Set AN/MRC-20 is an assembly of high-frequency, very-high-frequency, and ultra-high-frequency transmitting and receiving equipment arranged for vehicular installation and operation.

This equipment is designed to provide a mobile communication system capable of operating on three different ranges, either separately, simultaneously, or automatically by voice control. As designed and used, this equipment increases the flexibility of ground and/or ground-to-air communications and enlarges the range of fixed stations.

Power is supplied by Power Unit PE-246; power required is 1,700 watts of 28.5-volt dc. For emergency use, a 28-volt, 35-ampere-hour storage battery will operate the equipment for approximately 30 minutes under normal conditions.

**RELATIONSHIP TO SIMILAR EQUIPMENT:**

**RADIO SET  
AN/MRC-20**

**TECHNICAL DESCRIPTION:**

*Frequency Range in Mc:*

Transmission: 0.2 to 1.5, 2 to 18.1, 100 to 156, 225 to 399.9.

Reception: 0.2 to 0.5, 2 to 18, 100 to 156, 225 to 399.9.

*Number of Preset Channels:*

Auto-tuned: 11; 200- to 500-kc, and 2-mc to 18-mc range.

Crystal controlled: 8; 100-mnc to 156-mc range.

Crystal-controlled: 18; 225-mc to 399.9-mc range.

*Total Number of Available Channels:* 1,750, spaced 100 kc apart.

*Type Modulation:* am.

*Type Emission:* A3 (voice, tone; cw may be used in hf and if ranges).

*Power Output:*

Transmitters: 10 w (nominal).

Receivers: 0.5 w to 3 w (nominal).

*Power Requirements:*

Power Unit: 1.7 kw at 28-v dc (60 amp).

Battery: 28.5 v dc (35 amp-hour) will operate set for 1/2 hour in emergency.

*Major Units:*

1	PE-246	16 7/8" x 20 1/2" x 24 3/8"	113.0 lbs.
1	BC-348-, or -R	18" x 9 1/2" x 10 1/2"	41.0 lbs.
1	R-77/ARC-3	11" x 6" x 15 1/2"	17.0 lbs.
1	RT-178/ARC-27	12 3/8" x 11 1/4" x 27 7/8"	71.0 lbs.
1	C-626/ARC-27	6 3/8" x 9 9/16, " x 5 1/4"	11.2 lbs.
1	C-628/ARC-27	3 1/4" x 8 1/2" x 3"	1.3 lbs.
1	T-47A/ART-13	23 1/2" x 11 1/2" x 14 1/2"	103.6 lbs.
1	T-67/ARC-3	12 1/4" x 7 1/2" x 15"	17.5 lbs.
2	RC-261	4 1/4" x 4 1/4" x 8 1/2"	21.0 lbs.

**TUBES, CRYSTALS, TRANSISTORS:**

**REFERENCE DATA AND LITERATURE:**

TO 31R2-2MRC20-14.

RADIO SET  
AN/MRC-40

July 1962  
Cog. Serv.: USA FSN:  
USA Line Item No: 638810

---

USA    USN    USAF    USMC

---

**STATUS OR TYPE CLASS.:**

---

Manufacturer: MCSC (Albany and Barstow).

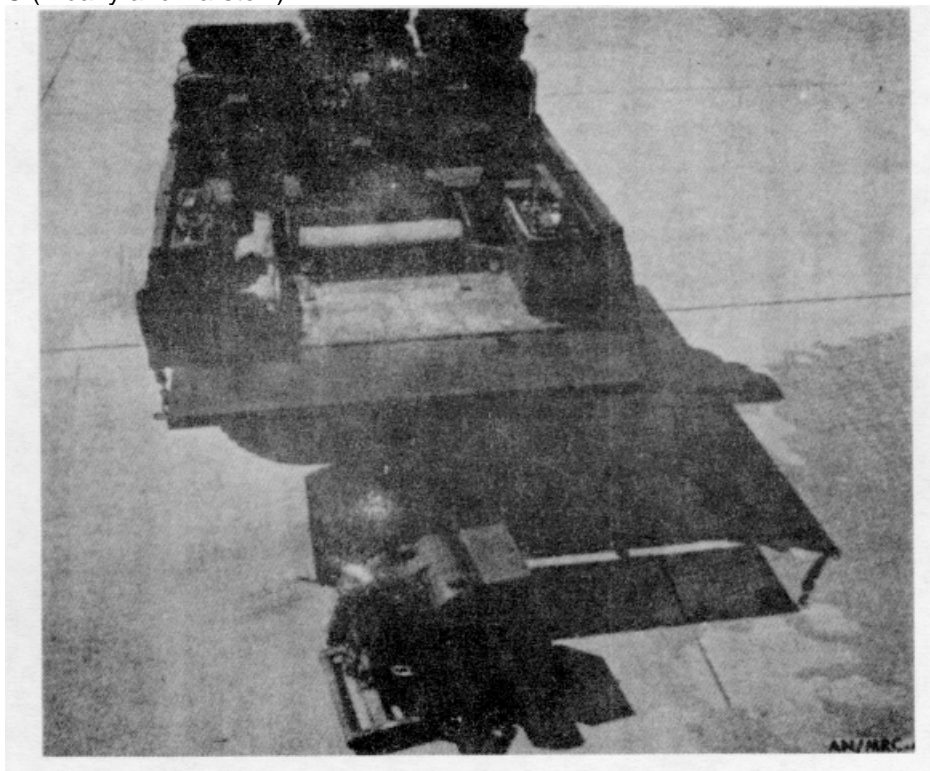

**FUNCTIONAL DESCRIPTION:**

Radio set designed for line of sight ultra-high-frequency communication between ground and aircraft mounted on Trailer M-195.

This equipment will net other equipment operating in the UHF band such as the TED, TDZ, AN/URR-35A, AN/ARC-27, AN, ARC-55 and AN/GRC27.

**RELATIONSHIP TO SIMILAR EQUIPMENT:**

**RADIO SET  
AN/MRC-40**

**TECHNICAL DESCRIPTION:**

*Transmitter:*

Frequency Range: 225 to 399.9 ms.  
Frequency Control: Crystal.  
Frequency Stability: 10 kc.  
Type of Signal: Voice or mew.  
Type of Modulation: am.  
Audio Bandwidth: Wide 200 to 20, 000 cps, Narrow 400 to 3, 000 cps.  
Power Output: 100 watts.

*Receiver:*

Frequency Range: 225 to 399.9 ms.  
Type of Signal: Voice or mcw.

*Power Requirements:*

Engine Generator P-75 or PU-347/G.

**TUBES, CRYSTALS, TRANSISTORS:**

**REFERENCE DATA AND LITERATURE:**

RADIO SET  
AN/MRC-4125 November 1958  
Cog. Serv.: USA FSN:  
USA Line Item No:

	USA	USN	USAF	USMC
STATUS OR TYPE CLASS.:			L/Std	

Manufacturer:

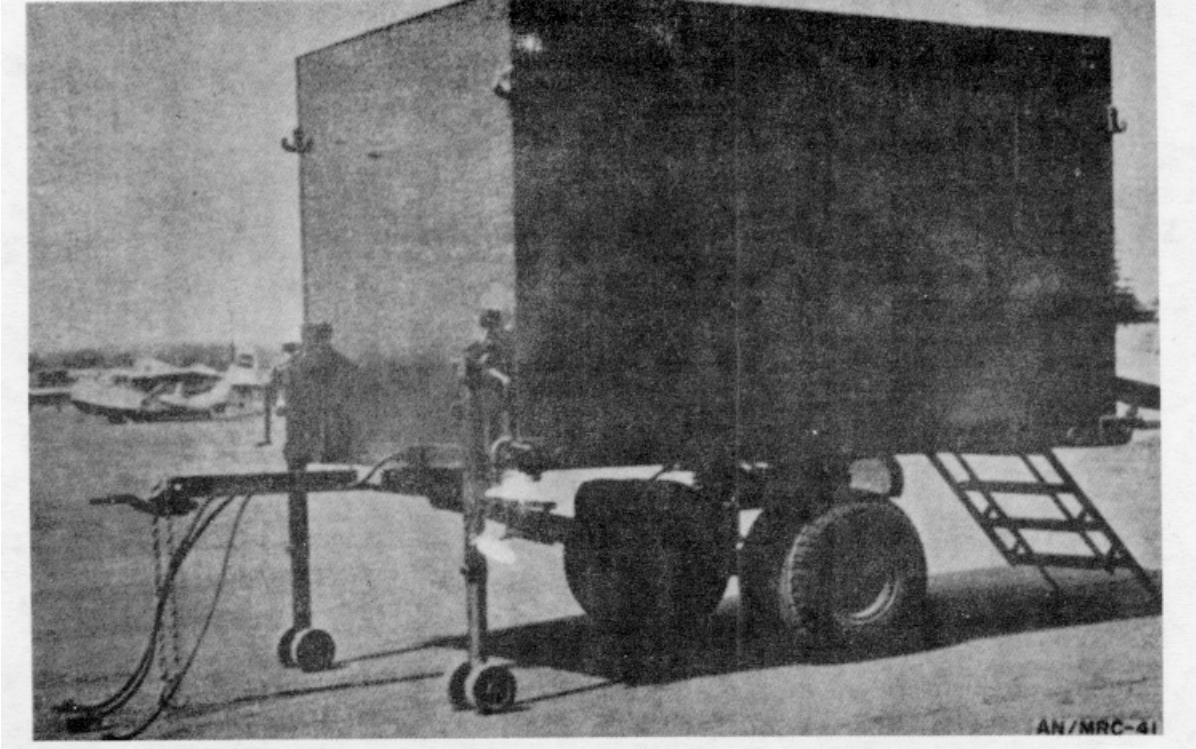
**FUNCTIONAL DESCRIPTION:**

Radio Set AN/MRC-41 is a highly mobile, air-transportable, radio relay unit capable of independent operation. It may also be employed with other mobile or permanent com-center facilities to provide ground-to-ground or point-to-point communication.

This equipment is used either as a relay or terminal station in continuous wave, voice, and diversity radioteletype communication. It is normally operated with Teletypewriter Central Office AN/MGC-2, Radio Receiving Set AN/MRR-5, and Radio Transmitting Set AN/MRT-6.

All operating components are installed and operated from Van Trailer V-83/M.

Power is supplied by trailer mounted Diesel Engine Generator Set Type MB-5; however, this item is not supplied as part of the radio set.

**RELATIONSHIP TO SIMILAR EQUIPMENT:**



**RADIO SET  
AN/MRC-41**

**TECHNICAL DESCRIPTION:**

*Frequency Range in Mc:* 230 to 250.

*Type Modulation:* fm (F3, F9)

*Type Signal:* Cw, voice, fsk.

*Power Output:*

Receiver: 0.5 w.

Transmitter. 5 W.

*Power Requirements:* 20 to 30 kw; 120- or 240-v, 50- to 60-cy 1-phase ac.

*Major Units:*

8 TA-182/U.

1 AN/TRC-12B.

1 AN/TCC 3.

**TUBES, CRYSTALS, TRANSISTORS:**

**REFERENCE DATA AND LITERATURE:**

MIL-R-9523.

**ANTENNA**  
**AN/MRC-type**  
**AT-1011/U**

15 October 1961

Cog. Serv.: USA FSN: 5895-846-6442

USA Line Item No:

	USA	USN	USAF	USMC
<b>STATUS OR TYPE CLASS.:</b>				Std

**Manufacturer:** Columbia Products Company

**No illustration available**

**FUNCTIONAL DESCRIPTION:**

Antenna AT-1011/U is a 32 foot, 8 section, fiber glass whip antenna for use in the 2-30 me. frequency range. Four tapered sections mount on the mast base, which is part of the antenna, to form a 16 foot flexible whip antenna for vehicular use. The remaining four identical sections may be inserted between the 16 foot flexible portion and the base to form a 32 foot whip for stationery use.

This antenna is used with Radio Sets AN/MRC-83, AN/MRC-87, AN/TSC-15 and AN/TRC-75. Because of its fiber glass construction the antenna is practically impervious to corrosion, and its performance is unimpaired by water or accumulations of dirt, grease, dried salt deposits and the like.

**RELATIONSHIP TO SIMILAR EQUIPMENT:**

The 16 foot vehicular portion of antenna AT-1011/U is functionally similar to an antenna made up of antenna mast sections MS-116, MS-117, and MS-118 along with antenna mast base MP-65 or AB-15/GR. The primary differences stem from the fact that antenna AT-1011/U is electrically insulated and made corrosion resistant by the use of fiberglass while the metal antenna sections MS-116, 117 and 118 are not.

**TECHNICAL DESCRIPTION:**

*Frequency Range:* 2-30 megacycles.

*Dimensions:*

Stationary Antenna Assembled: 32 ft.

Vehicular Portion Assembled: 16 ft.

Each Mast Section. 52" long by 1 5/17" diameter maximum.

Base. 20 1/2" high by 8 1/2" diameter. Mounting plate has six 13/32" holes equally spaced on 7 3/4" diameter circle.

*Wind Load:* The unguyed 32 ft antenna will safely withstand a 65 knot wind.

*Color:* Marine Corps Green.

*Major Units:*

Base:	8.25 lbs.
	10.66 lbs.

**TUBES, CRYSTALS, TRANSISTORS:**

**REFERENCE DATA AND LITERATURE:**

Columbia Products Company drawings 75371, 75361, 75391, 75381, 75431, and 75421  
 Purchase Description CSY-3-FY61-11.

RADIO SET  
AN/MRC-type  
SCR-399

1 March 1964

Cog. Serv.: USA FSN: 5820-355-8124

USA Line Item No: 652507

	USA	USN	USAF	USMC
STATUS OR TYPE CLASS.:	L/Std			

Manufacturer: The Hallicrafters Co.

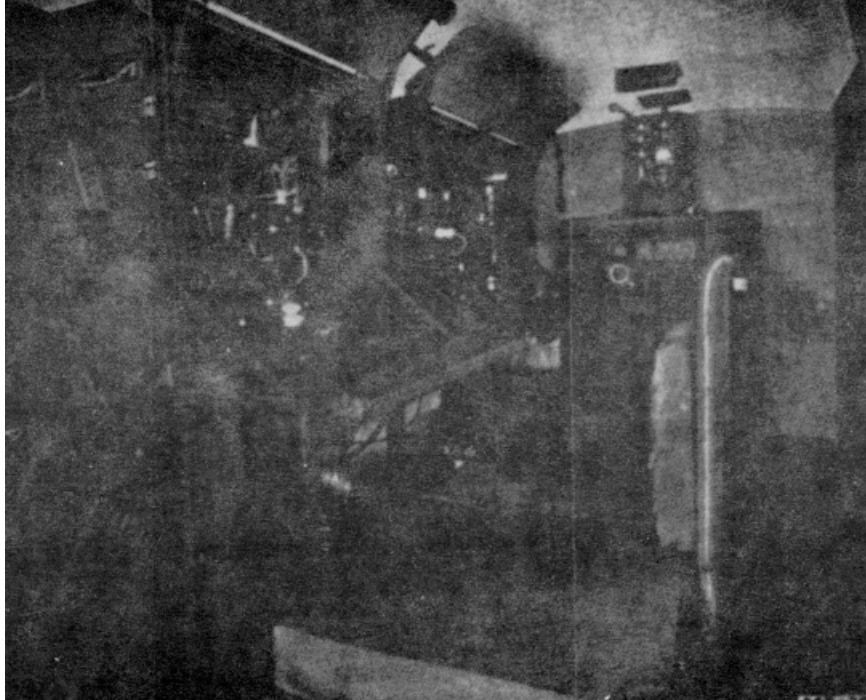

#### FUNCTIONAL DESCRIPTION:

Radio Set SCR-399 is a field, mobile, transmitting and receiving station used for am voice, tone, or cw communication, over medium or long distances, in the medium- and high-frequency ranges.

The equipment consists of transmitting, receiving, control, and related components installed within Shelter HO-17, which is carried on a 2 1/2 ton, 6 x 6 cargo truck, and can operate on the move or at the halt.

It includes remote-control components by means of which the equipment can be operated from locations up to 2 miles away, over a telephone pair, in conjunction with Telephone EE-8.

It can be used in the l-mc range by means of Frequency Conversion Kit MC-509.

It uses vehicular whip-type antenna systems. At the halt, when the operating range must be extended, it can be used with more elaborate arrays, such as doublet systems.

A trailer-drawn, 5-kw power unit is included to provide power for this set.

Radio Set SCR-499 is the air-transportable version of this equipment.

**RADIO SET  
AN/MRC-type  
SCR-399**

**RELATIONSHIP TO SIMILAR EQUIPMENT:**

**TECHNICAL DESCRIPTION:**

*Frequency Range in mc:*

Transmitting: 2 to 18.

Receiving: 1.5 to 18.

*Type Modulation:* am.

*Type of Signal:* Voice, tone, or cw.

*Power Output:*

Voice: 300 w.

Cw: 400 w.

*Power Requirement:* 2,500 w 115-v 60-cy ac (supplied by PE-95 or equivalent); and 12-v storage battery.

*Major Units:*

1	BC-939		
1	PE-95-G	75 1/2" x 28 1/2" x 38 1/2"	1,545 lbs.
1 ea	BC-312, BC-342	10" x 9 1/16" x 18 1/16"	58.0 lbs.
1	BC-610-( )	32 5/8" x 21 3/8" x 39 7/8"	452 lbs.
1	HO-17	159" x 92" x 80"	7,255 lbs.
1	BC-614-E	16" x 9 1/4" x 11"	

**TUBES, CRYSTALS, TRANSISTORS:**

**REFERENCE DATA AND LITERATURE:**

TM 11-281.

(USA) 71-1683A.

**RADIO RECEIVING SET  
AN/MRR-4( )**

1 March 1964

Cog. Serv.: USA FSN: 5820-546-6505

USA Line Item No: 636220

	USA	USN	USAF	USMC
<b>STATUS OR TYPE CLASS.:</b>	Std B			

**Manufacturer:** Gates Radio Co.

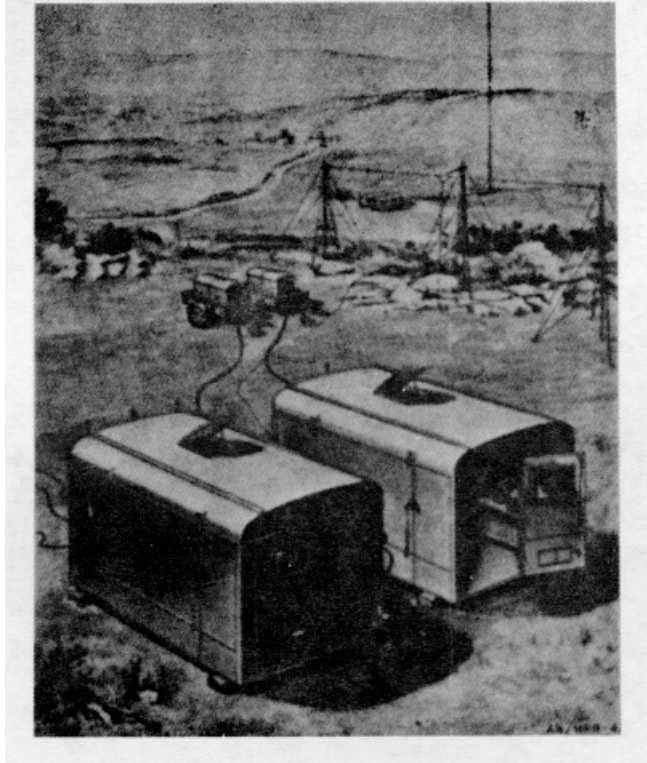

**FUNCTIONAL DESCRIPTION:**

Radio Receiving Set AN/MRR-4( ) is a transportable voice, cw, and radioteletype receiving station for (a) aural monitoring, (2) magnetic tape recording of broadcasts, either picked up by radio receivers or transmitted over landline, (3) receiving programs of remote origin for direct rebroadcast, (4) receiving programs, or other information by radioteletype circuits, and (5) sending and receiving information by a landline teletypewriter system.

This equipment, consisting of a radio receiving and a radioteletype shelter, normally functions as the receiving terminus for Radio Transmitting Set AN/MRT-5. It includes push-button and patchboard facilities that enable rapid connection of system components to the AN/MRT-5 or similar radio stations. The shelters, which house all of the operating components except the power units, include panoramic indicators, a teletypewriter, a perforator transmitter, radio receivers, magnetic tape recorders, telephones, and accessories.

The two shelters are powered by trailer-drawn, 10-kw power units and are readily transported by standard 6 x 6 trucks.

**RADIO RECEIVING SET  
AN/MRR-4( )**

The AN/MRR-4 and AN/MRR-4A are functionally identical and all components are interchangeable.

**RELATIONSHIP TO SIMILAR EQUIPMENT:**

**TECHNICAL DESCRIPTION:**

*Frequency Range in mc:* 0.1 to 0.4, 1.35 to 29.4 in 6 bands (Hammarlund rcvr Mod SP 60(JLX); 0.54 to 54 in 6 bands (R-274A/FRR).

*Type Modulation:* am.

*Type of Signal:* cw, tone, voice, radioteletype.

*Power Requirements:* 130 w, 115-v 60-cy ac (except for battery-operated telephone system).

*Major Units:*

2 ea Power Unit PE-95-( ); 1 ea Radio Receiving Shelter MO-4027, Radio.  
Teletypewriter Shelter MO-4026 81" x 78" x 145"

4,863 lbs.

**TUBES, CRYSTALS, TRANSISTORS:**

**REFERENCE DATA AND LITERATURE:**

TM 11-646.  
MIL-R-11601.

RADIO RECEIVING SET  
AN/MRR-5

25 November 1958

Cog. Serv.: USA FSN: 5895-505-1041B

USA Line Item No:

	USA	USN	USAF	USMC
STATUS OR TYPE CLASS.:			L/Std	

Manufacturer: Craig Systems, Inc.

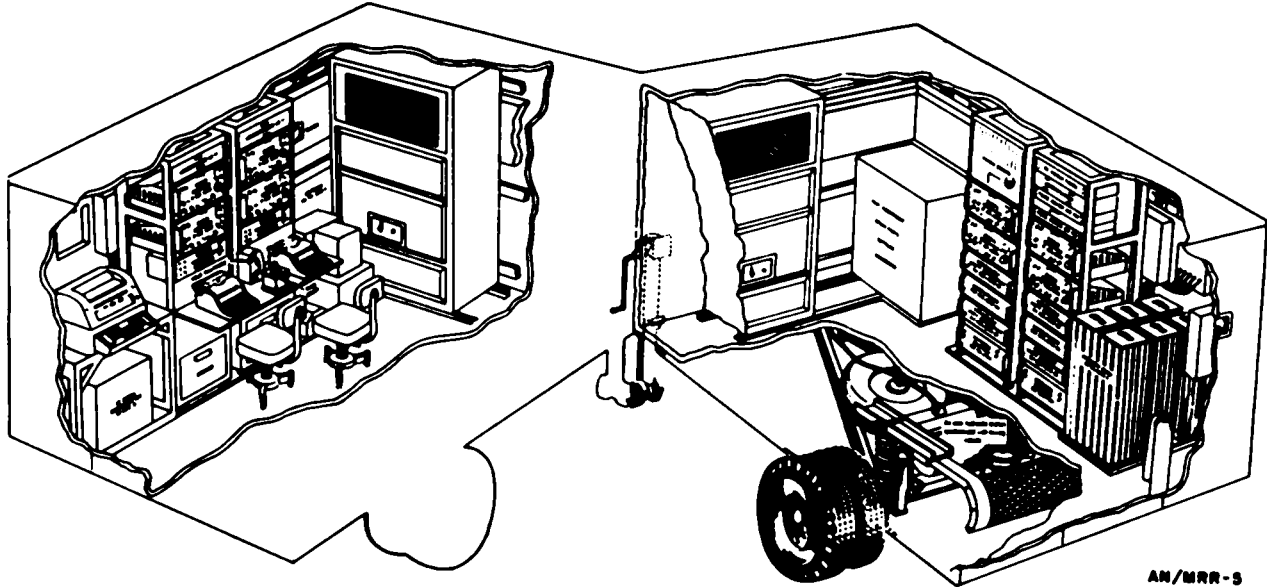

AN/MRR-5

**FUNCTIONAL DESCRIPTION:**

Radio Receiving Set AN/MRR-5 is a highly mobile, air-transportable equipment designed to operate with other mobile or permanent communication centers, as a part of a ground-to-air or point-to-point communications system.

This equipment has remote controls for operating Radio Transmitting Set AN/MRT-6 and is suitable for operation with Radio Beacon AN/URN-5, Radio Transmitting Set AN/URT-7, and Radio Transmitting Equipment TED-2. It is normally used with Teletypewriter Central Office AN/MGC-2, Radio Set AN/MRC-41, and Radio Transmitting Set AN/MRT-6.

All operating components are installed in and are operated from Van Trailer V-83/M.

Power is supplied by Trailer-Mounted Diesel Engine Generator Set Type MB-5, which is not supplied as part of the set or of commercial facilities.

**RELATIONSHIP TO SIMILAR EQUIPMENT:****TECHNICAL DESCRIPTION:**

*Frequency Range in mc:* 0.5 to 30.5.

*Coverage:* Continuous.

*Tuning Steps:* 30.

*Type Modulation:* am (A1, A2, A3); fm (F1).

*Type Emission:* cw, tone, voice, fsk.

*Power Output:* 1.5 w; 4 or 600 ohms.

**RADIO RECEIVING SET  
AN/MRR-5**

*Power Requirements:* 20 kw to 30 kw; 120- or 240-v 50- to 60-cy -phase ac.

*Major Units:*

3 AN/GRA-

2 NR-174.

8 R-388/URR

1 TT-70A/UGO.

10 1/2" x 19" x 13 11/16"

35 lbs.

**TUBES, CRYSTALS, TRANSISTORS:**

**REFERENCE DATA AND LITERATURE:**

TO 31R2-2MRR5-1, -2, -4.

MIL-R-9518.



**RADIO RECEIVING SET  
AN/MRR-6**

25 November 1958  
Cog. Serv.: USA FSN:  
USA Line Item No:

STATUS OR TYPE CLASS.:	USA	USN	USAF	USMC
			L/Std	

Manufacturer:

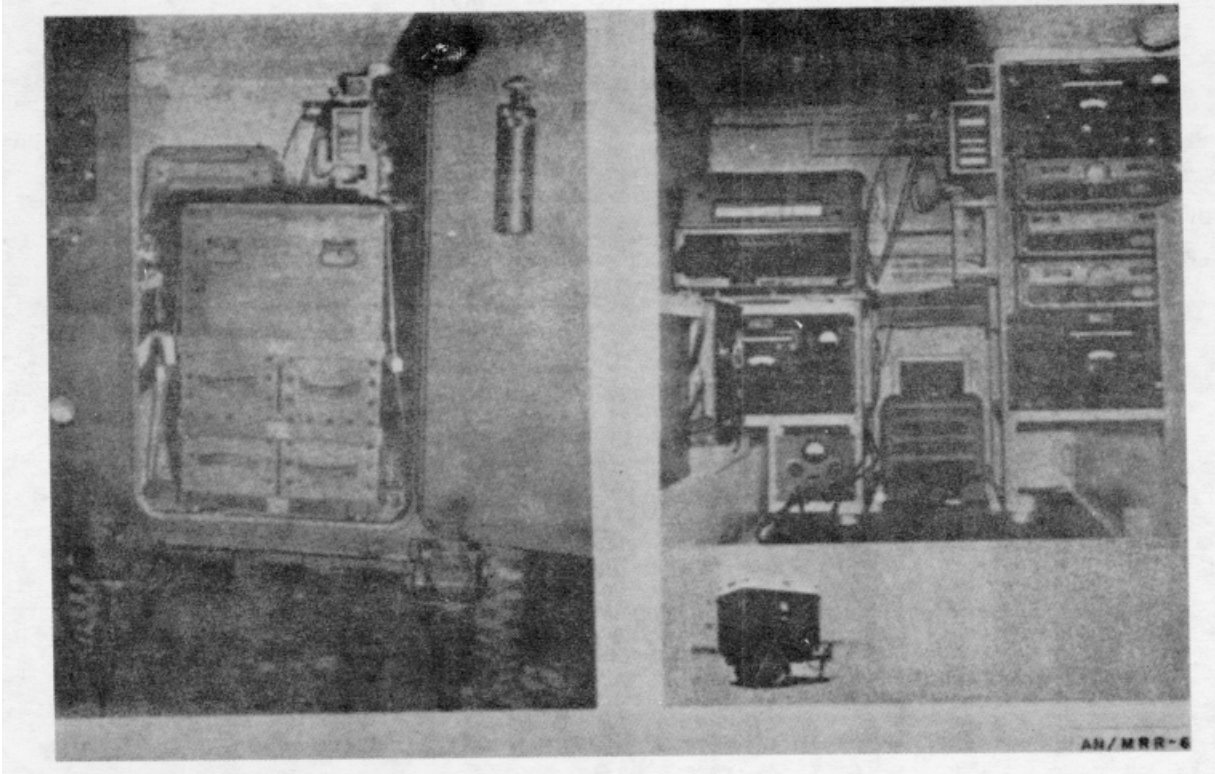

**FUNCTIONAL DESCRIPTION:**

Radio Receiving Set AN/MRR-6 is a highly mobile and air-transportable equipment designed for reception and printing of radioteletype signals transmitted by the frequency-shift method or by voice and continuous wave signals. It is employed in short duration (up to three months) for emergency support of Airways and Air Communications Service air operations.

This equipment includes remote controls for operation of Radio Transmitting Set AN/MRT-7 and can receive radio teletype signals through Frequency Shift Converter-Comparator, Northern Radio Type 174, operating with Teletypewriter TT-70/UG.

Radio Receiving Set AN/MRR-6 is usually operated with Air Traffic Control Set AN/MRN-15, Radio Transmitting Set AN/MRT-7, and Facsimile Set AN/MXR-1.

All operating components are installed in and operated from a trailer van.

Power is supplied by Trailer Mounted Diesel Engine Generator Set MB-6; however, this item is not supplied as part of the set.

**RELATIONSHIP TO SIMILAR EQUIPMENT:**

**RADIO RECEIVING SET  
AN/MRR-6**

**TECHNICAL DESCRIPTION:**

*Frequency Range in mc:* 0.5 to 30.5.

*Coverage:* Continuous

*Tuning Steps:* 30.

*Type Modulation:* am (A1, A2, A3); fm (F1).

*Type Emission:* cw, tone, voice, fsk.

*Power Output:* 1.5 w; 600 ohms.

*Power Requirements:* 5 kw; 240-v 50- to 63-cy 3-wire 1-phase ac.

*Major Units:*

1	NR-174		
3	R-388/URR	10 1/2" x 19" x 13 11/16"	35 lbs.
1	RA-133		
1	TT-70/UO		

**TUBES, CRYSTALS, TRANSISTORS:**

**REFERENCE DATA AND LITERATURE:**

RADC-2448.

**RADIO TRANSMITTING SET  
AN/MRT-5( )**

1 March 1964

Cog. Serv.: USA FSN: 5820-503-2635

USA Line Item No: 657950

	USA	USN	USAF	USMC
<b>STATUS OR TYPE CLASS.:</b>	Std B			

Manufacturer: Gates Radio Co.

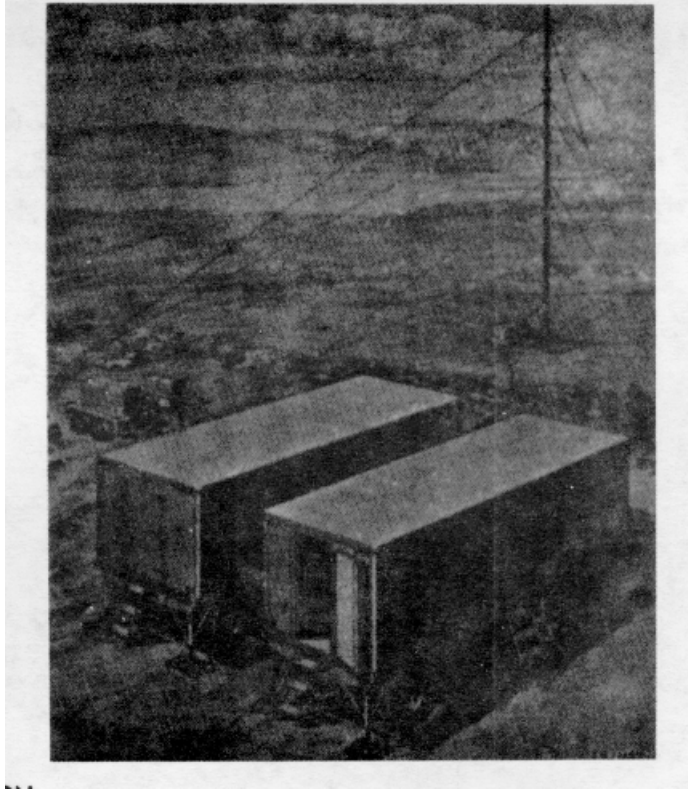

**FUNCTIONAL DESCRIPTION:**

Radio Transmitting Set AN/MRT-5( ) is a transportable radio station that provides complete radio transmission facilities in the standard am broadcast band. This equipment, when used with Radio Receiving Set AN/MRR4( ), is a complete radio station for dissemination of information for entertainment and psychological warfare services.

All operating components, with the exception of the two power units and the antennas, are housed in the transmitting trailer, the studio trailer, and the antenna tuning shelter. The transmitting trailer supplies facilities for generating, amplifying, and transmitting the rf carrier; and the studio trailer, for all local programming. The antenna tuning shelter provides for tuning the antenna and feeding the modulated rf to the mast antenna or the balloon-carried antenna. Provisions are made for transmitting programs originated at a remote point.

Main power for the transmitting trailer and the antenna tuning shelter is furnished by Power Unit PE-85/M; and for the studio trailer, by Power Unit PE-95-G.

The AN/MRT and AN/MRT-5A differ somewhat; a variable-frequency oscillator and Radio Receiver R-388/URR are added to the transmitting trailer of the A model.

**RADIO TRANSMITTING SET  
AN/MRT-5( )**

**RELATIONSHIP TO SIMILAR EQUIPMENT:**

**TECHNICAL DESCRIPTION:**

*Frequency Range in mc:* 0.54 to 1.6.

*Type Modulation:* am.

*Type of Signal Voice.*

*Power Output:* 5 kw.

*Power Requirements:*

Transmitter: 15.5 kw, 230-v 60-cy 3-phase ac.

Studio Shelter: 115-v 60-cy 1-phase ac.

*Major Units:*

1	AB-127( )/FR, 1 Antenna tuning shelter	82" x 78" x 145"
1	ea Studio trailer, Transmitting trailer	95 1/2 x 131 3/4" x 318"

**TUBES, CRYSTALS, TRANSISTORS:**

**REFERENCE DATA AND LITERATURE:**

TM 11-643.

MIL-R-11601.

RADIO TRANSMITTING SET  
AN/MRT-6

25 November 1958  
 Cog. Serv.: USA FSN:  
 USA Line Item No:

	USA	USN	USAF	USMC
STATUS OR TYPE CLASS.:			L/Std	

Manufacturer: Craig Systems, Inc.

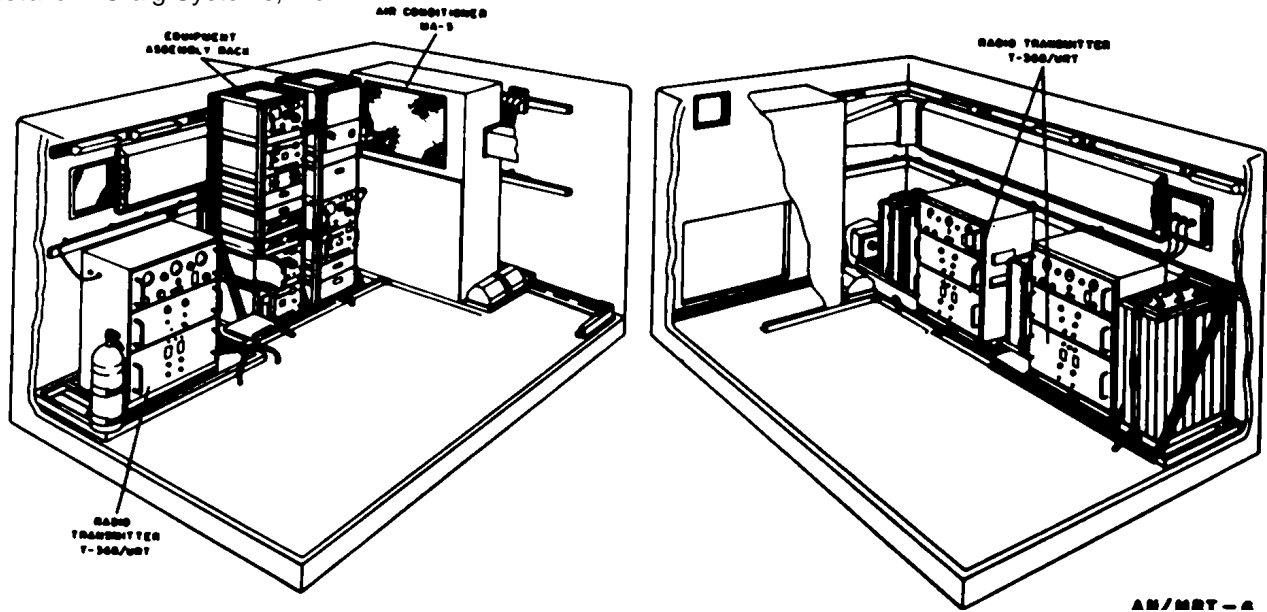

## FUNCTIONAL DESCRIPTION:

Radio Transmitting Set AN/MRT-6 is a mobile, air-transportable, high frequency transmitting station that is used for ground-to-air and point-to-point radio transmission. The facility is entirely self-contained, except for primary power, and may be operated independently or in conjunction with other airport communication equipment.

Various components of this set may be remotely controlled by Radio Receiving Set AN/MRR-5.

This equipment is normally operated with Teletypewriter Central Office AN/MOC-2, Radio Set AN/MRC-41, and Radio Receiving Set AN/MRR-5, and is installed in and operated from Van Trailer V-83/M.

Power is supplied by Trailer Mounted Diesel Engine Generator Set Type MB-5; however, this item is not supplied as part of the set. Where available, commercial power may be used.

## RELATIONSHIP TO SIMILAR EQUIPMENT:

## TECHNICAL DESCRIPTION:

*Frequency Range in mc:* 1.5 to 20.

*Number of Bands:* 5.

*Type Modulation:* am, fm.

*Type Emission:* cw, tone, voice, fsk (A1, A2, A3, F1).

*Power Output:* 375 w (voice); 475 w (cw).

*Power Requirements:* 20 kw to 30 kw; 120- or 240-v 50- to 60-cy 1-phase ac.

**RADIO TRANSMITTING SET  
AN/MRT-6**

*Major Units:*

- 3 Antenna Coupler Type TA-1.
- 3 Antenna Tuning Unit Model TAC.
- 2 Frequency Shift Converter NR Type 152.
- 3 Frequency Shift Keyer, Model XFK.
- 2 sets Frequency determining network.
- 1 Headset HS-33A.
- 3 Oscillator, variable frequency.
- 1 SB-502/M.
- 3 T-368/URT.
- 1 RF Patch Panel 76G37.
- 1 Trailer, van V-83M.

**TUBES, CRYSTALS, TRANSISTORS:**

**REFERENCE DATA AND LITERATURE:**

TO 31R2-2MRT6-1, -2, -4.  
MIL-T-9519.

RADIO TRANSMITTING SET  
AN/MRT-7

25 November 1958  
 Cog. Serv.: USA FSN:  
 USA Line Item No:

	USA	USN	USAF	USMC
STATUS OR TYPE CLASS.:			L/Std	

**Manufacturer:**

No illustration available

**FUNCTIONAL DESCRIPTION:**

Radio Transmitting Set AN/MRT-7 is an air-transportable, mobile, high frequency equipment used to transmit voice, frequency-shift telegraph, and intermediate frequency beacon signals. It is suitable for worldwide communication use and in short-duration (3 months) emergency support applications of Airways and Air Communications Service operations.

This equipment can be operated by remote control from Radio Receiving Set AN/MRR-6. It is used with Air Traffic Control Set AN/MRN-15, Radio Receiving Set AN/MRR-6, and Facsimile Set AN/MXR-1.

All operating components are installed in and operated from a trailer van. Power for operation is derived from Trailer-Mounted Diesel Engine Generator Type MB-6; however, this item is not supplied as part of the radio transmitting set.

**RELATIONSHIP TO SIMILAR EQUIPMENT:****TECHNICAL DESCRIPTION:**

*Frequency Range in mc:* 0.2 to 0.4; 1.5 to 15.

*Type Modulation:* am, fm.

*Type Emission:* A1, A2, A3, F1 (cw, tone, voice, fsk).

*Power Output:*

A2, A3: 15 w.

A2, A3: 50 w.

A1, F1: 75 w.

*Power Requirements:* 5 kw; 240-v 50- to 63-cy 3-wire 1-phase ac.

*Major Units:*

- 1 Frequency Shift Keyer, Model XFK.
- 2 Oscillator, Model PMO.
- 1 Radio Telephone Transmitting Equipment TDD-4.
- 2 Radio Transmitter, CR Model 32-BA-9.
- 1 Shelter with trailer mounting chassis.

**TUBES, CRYSTALS, TRANSISTORS:****REFERENCE DATA AND LITERATURE:**

RADC-2449.

RADIO SET  
AN/MRT-type  
SCR-573-( )

1 March 1964

Cog. Serv.: USA FSN:

USA Line Item No: 654485

	USA	USN	USAF	USMC
STATUS OR TYPE CLASS.:			L/Std	

Manufacturer: Bendix Radio Corp.

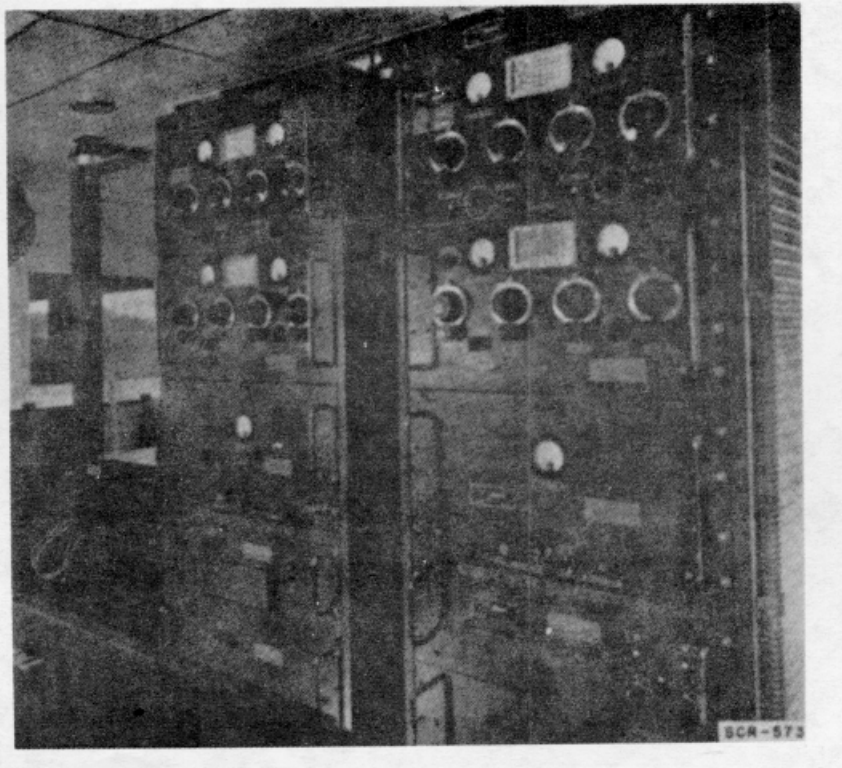

#### FUNCTIONAL DESCRIPTION:

Radio Set SCR-573-( ) is am or tone-modulated, vhf, transmitting equipment for ground-to-air, and point-to-point communication. It is normally operated as mobile equipment from Truck K-53 and Trailer K-63, both of which are supplied. Radio Set SCR-573-A (transmitting station), when used with Radio Set SCR-574-A (receiving station), comprises a two-way, VHF Fighter Control Net System.

Two Radio Transmitters BC-640, each operating on one preset, crystal-controlled frequency, provide dual channel transmission.

This equipment can be controlled locally, or remotely over standard telephone lines from a distance of 60 to 120 miles. The distance between transmitters and receivers should be at least 1 mile because the transmitters may block out receivers operating in adjacent channels. Separation between transmitting and receiving stations at the same terminal installation should not exceed 2 miles.



**RADIO SET  
AN/MRT-type  
SCR-573-( )**

Recommended antenna system consist of Antenna AN-86 (76 feet), two Antenna Equipments RC-81, and associated coaxial cable.

Power is normally furnished by Power Unit PE-99 (part of Radio Set SCR-573), or an equivalent source.

**RELATIONSHIP TO SIMILAR EQUIPMENT:**

**TECHNICAL DESCRIPTION:**

*Frequency Range in mc:* 100 to 156.

*Type Modulation:* am.

*Type of Signal:* Voice or tone.

*Power Output:* 50 w per transmitter.

*Power Requirement:* 2.5 kva 10v 50/60 cy 1 phase ac (without heater); or 7.5 kvs 120v 50/60 cy 3-phase ac (with heater).

*Major Units:*

2	RC-81-A	12" x 28" x 38"	4 lbs.
1	RM-27	11 3/8" x 19" x 10 1/2"	29 lbs.
2	BC-640	72" x 21" x 20"	515 lbs.
1	Trailer K-63 (with Power Unit PE99)	72" x 72" x 144"	2,860 lbs.
1	Truck K-53	130" x 96" x 256"	13,385 lbs.

**TUBES, CRYSTALS, TRANSISTORS:**

**REFERENCE DATA AND LITERATURE:**

TM 11-866.  
TO AN-40SCR573-2.  
USA 271-1336.

RADIO TRANSMITTER  
AN/MRT-type  
T-208/U

1 March 1964

Cog. Serv.: USA FSN: 5820-545-7268

USA Line Item No: 691929

	USA	USN	USAF	USMC
STATUS OR TYPE CLASS.:	Std A			

Manufacturer: Motorola, Inc.

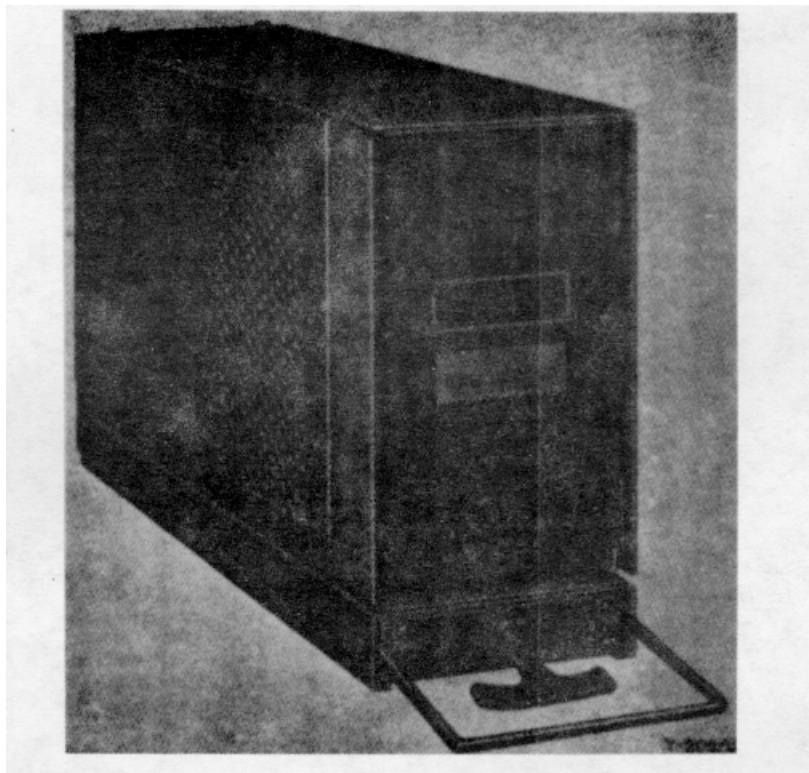

#### FUNCTIONAL DESCRIPTION:

Radio Transmitter T-208/U is an fm radio transmitter designed for mobile use. It is intended for use in system applications to provide point-to-point communication, or radio relay service by retransmission.

This transmitter is used as a component of Radio Set AN/VRC-6( ).

Provision is made for operation on either of two preset crystal-controlled frequencies.

#### RELATIONSHIP TO SIMILAR EQUIPMENT:

#### TECHNICAL DESCRIPTION:

*Frequency Range in mc:* 25 to 50.

*Type Modulation:* fm.

*Type of Signal:* Voice.

*Power Output:* 25 w.

RADIO TRANSMITTER  
AN/MRT-type  
T-208/U

*Power Requirements:* Dynamotor DY-93/G (20 amp at 12-v dc), Dynamotor DY-98/G (10 amp at 24-v dc); or Dynamotor DY-100/U (40 amp at 6-v dc); none of these dynamotors are supplied with this equipment.

*Major Unit:*

1 T-208/U 8 1/2" x 4 1/2" x 14 1/2"

(Equipment consists of only one major component; it relies on other system components for power and control functions.)

**TUBES, CRYSTALS, TRANSISTORS:**

**REFERENCE DATA AND LITERATURE:**

TM 11-804.  
MIL-N-11539.

**CONTROL SWITCHBOARD  
AN/MTC-type  
SB-100/MTC**

1 March 1964

Cog. Serv.: USA FSN: 6110-164-8067

USA Line Item No: 611314

	USA	USN	USAF	USMC
<b>STATUS OR TYPE CLASS.:</b>	Std A		Std	

**Manufacturer:** General Development Corp.

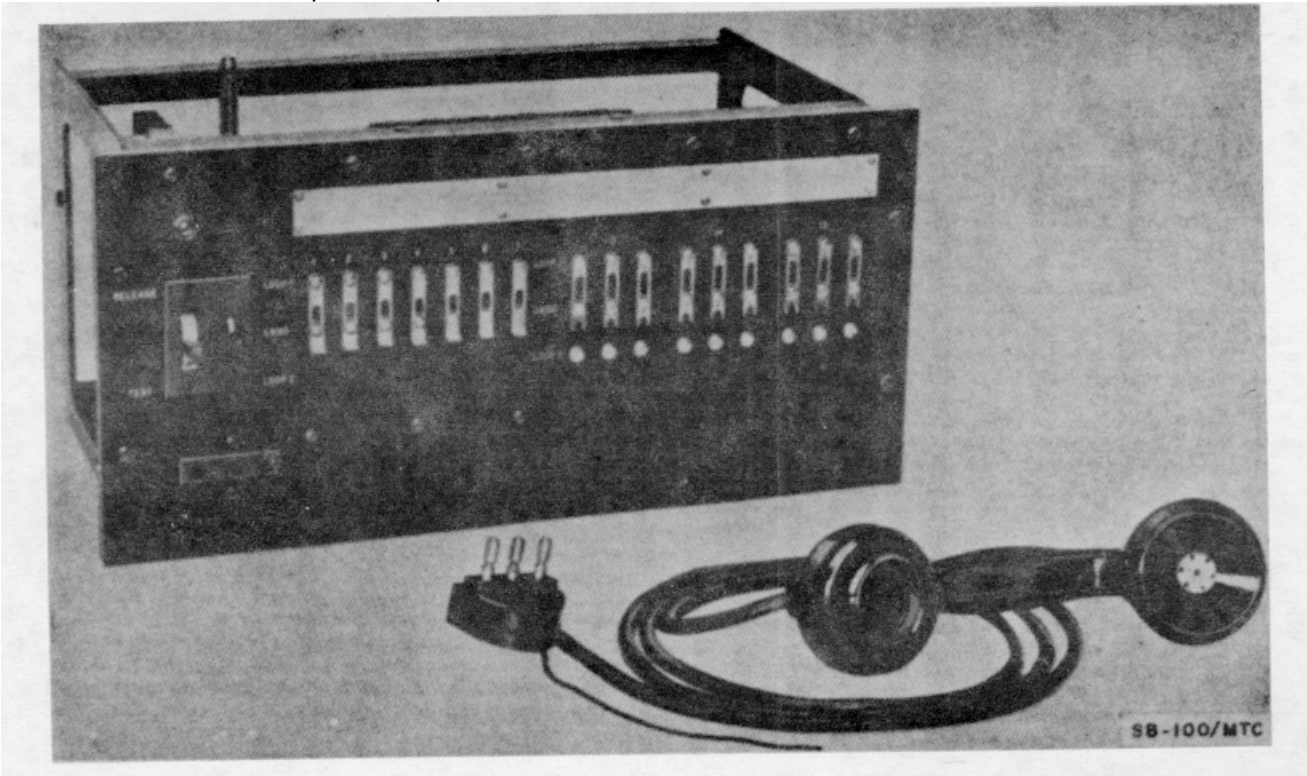

**FUNCTIONAL DESCRIPTION:**

Control Switchboard SB-100/MTC is semiautomatic equipment used for quickly grouping field telephones of a network for alerts, conferences, and instructions. It is usually mounted atop the administrative switchboard.

This equipment, consisting of the switchboard component and a handset has no means for ringing and signaling.

**RELATIONSHIP TO SIMILAR EQUIPMENT:**

**TECHNICAL DESCRIPTION:**

*Number of Positions:* 1.

*Number and Type of Circuits:* 14 manually operated lines.

*Power Requirements:* 3-v dc; 0.5 amp at 24-v dc.

*Major Unit:*

1	Control Switchboard	8" x 17" x 9 3/16"	20 lbs.
---	---------------------	--------------------	---------

**CONTROL SWITCHBOARD**  
**AN/MTC-type**  
**SB-100/MTC**

**TUBES, CRYSTALS, TRANSISTORS:**

**REFERENCE DATA AND LITERATURE:**

TM 11-2133.  
MIL-S-12662.

OPERATIONS CENTER  
AN/MTQ-1( )

1 March 1964

Cog. Serv.: USA FSN: 5895-537-7440

USA Line Item No: 6288115

	USA	USN	USAF	USMC
STATUS OR TYPE CLASS.:	Obs			

Manufacturer: Wickes Engr. &amp; Construction Co.

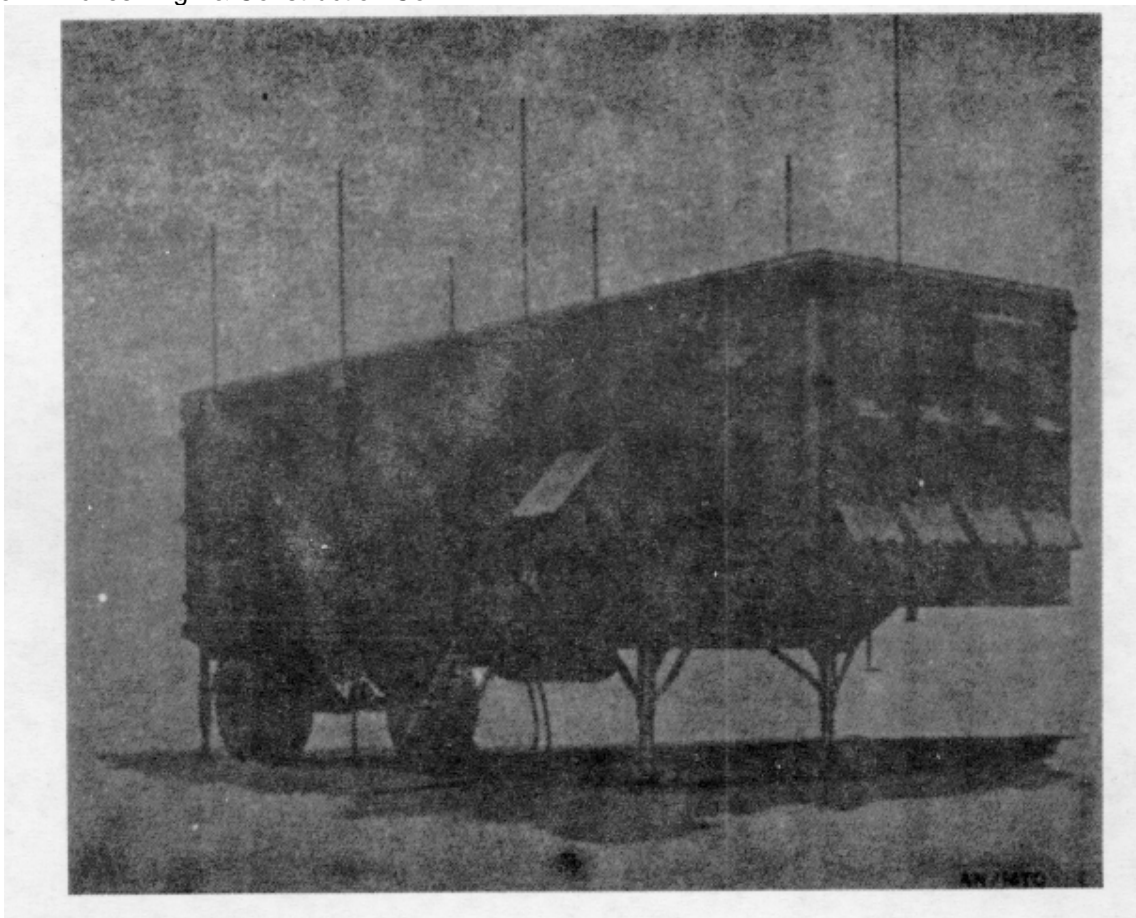
**FUNCTIONAL DESCRIPTION:**

Operations Center AN/MTQ-1( ) is a mobile operations center used as the tactical or battle headquarters of an antiaircraft defense command to collect, evaluate, and disseminate intelligence, and to direct firing when necessary.

This equipment, consisting of three trailers (an equipment trailer and two power trailers), is not designed to operate on the move.

The equipment van contains telephone teletypewriter, radar repeater, and radio equipment, display boards, air conditioning equipment, and accessory items. Communication equipment is not supplied but facilities for mounting such equipment are provided.

The AN/MT-1, AN/MTQ-1A, and AN/MTQ-1B are functionally identical. Each operations center normally requires 220-volt, 3-wire, 1-phase ac power, but can be operated on 110 volts if the air conditioning equipment is not connected. Power is normally supplied by a trailer-mounted Power Unit PE-95-( ) but commercial power may be substituted, if available.

**RELATIONSHIP TO SIMILAR EQUIPMENT:**

**OPERATIONS CENTER  
AN/MTQ-1( )**

**TECHNICAL DESCRIPTION:**

*Power Requirements:* 10 kw 220-v 60-cy 3-wire 1-phase ac; or 4 kw 110-v 60-cy 2-wire 1-phase ac without air conditioning equipment.

*Major Units:*

1	VK-4		378 lbs.
3	C-199/TTQ	6 7/16" x 4 7/16" x 5 1/4"	5.5 lbs.
1	PP-327/GRC-9Y	15 1/4" x 20 5/8" x 8 1/2"	85 lbs.
1	PP-989/MTQ1	24" x 12" x 48"	270 lbs.
1	AN/SPA-4	18" x 21 3/4" x 37 13/16"	315 lbs.
1	RE-8A/TTQ	19 3/4" x 8 1/2" x 5 1/2"	24 lbs.
1	RF-24C/TTQ	48" x 24" x 12"	210 lbs.
1	FN-61/MTQ-1	24 1/4" x 15 1/4" x 29 1/2"	23.5 lbs.
2	Trailer Mounted Gasoline Engine	97" x 83" x 165 1/2"	4,500 lbs.
1	V-79/G	135" x 95 1/2" x 363"	10,500 lbs.
1	AM-549/MTQ-1	8 1/4" x 7 1/2" x 5 1/2"	12 lbs.

**TUBES, CRYSTALS, TRANSISTORS:**

**REFERENCE DATA AND LITERATURE:**

TM 11-5550.  
MIL-O-10605.

TELETYPEWRITER SET  
AN/PGC-1

1 March 1964

Cog. Serv.: USA FSN: 5815-198-5963

USA Line Item No: 680750

	USA	USN	USAF	USMC
STATUS OR TYPE CLASS.:	Std A		Std	

Manufacturer: National Cash Register Co.

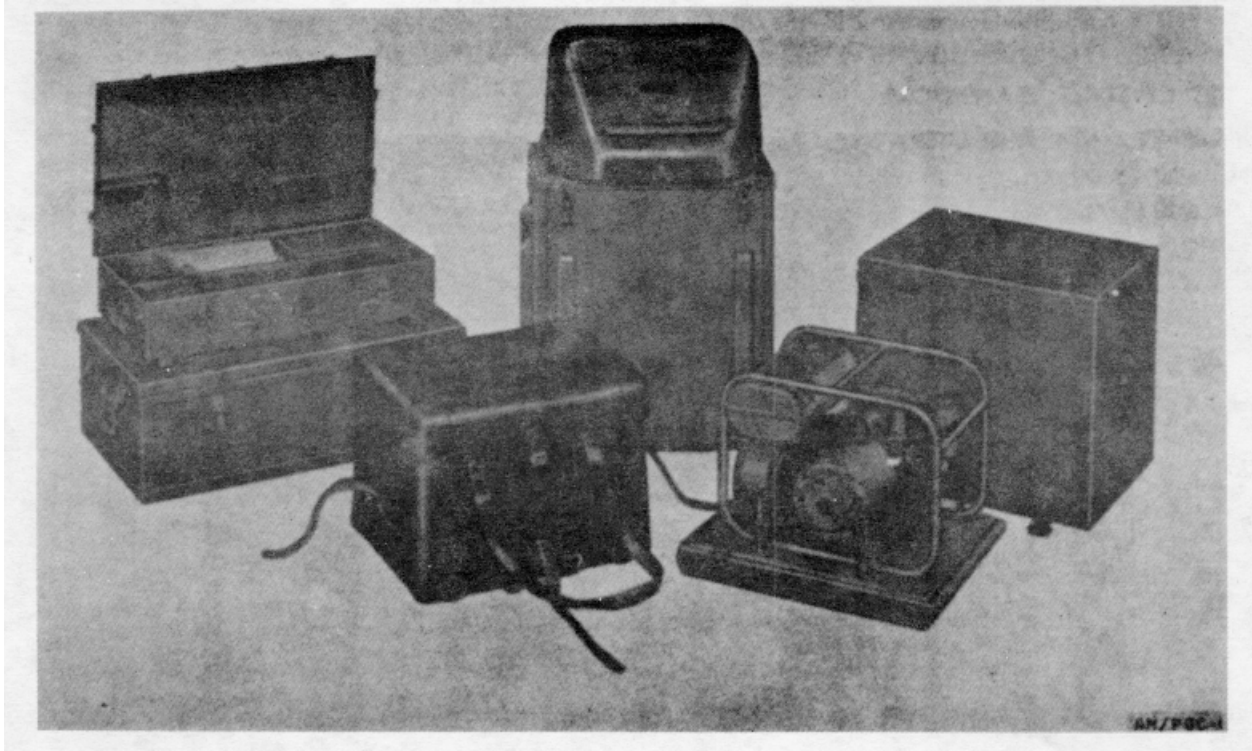
**FUNCTIONAL DESCRIPTION:**

Teletypewriter Set AN/PGC-1 is a portable, field teletypewriter station.

This equipment consists of a lightweight teletypewriter, a gasoline-engine-driven electrical generator, carrying cases, and accessories. The cases are used to mount the equipment during operation in the field. The entire equipment can be transported on packboards.

This set is designed to operate in neutral circuits but can be adapted to receive and transmit polar signals. It is usually connected to the remote teletypewriter through a dc telegraph line, tactical carrier facilities, or a radio channel. It can be arranged for half-duplex, full-duplex, or sending- or receiving-only operation. Two or more of these sets can be interconnected for operation with each other without using intermediate line modifying equipment.

**RELATIONSHIP TO SIMILAR EQUIPMENT:**



**TELETYPEWRITER SET  
AN/PGC-1**

**TECHNICAL DESCRIPTION:**

*Operating Functions:* Keyboard operation; remote motor stop and break-in facilities; no weather keyboard available.

*Operating Speed:* 368.1 opm (60 wpm); gears furnished for 600 opm (100 wpm); 72 characters per line.

*Motor Characteristics:* Universal (ac or de) series type, tuning fork speed adjusting frequency 3, 600 rpm.

*Power Requirements:* 150 w 105/125-v dc or 105/125-v 50/60-cy sc.

*Major Units:*

1	Engine-Generator PU-181/PC-1	17 1/2" x 12 3/4" x 14 3/4"	95	lbs.
1	Teletypewriter TT-4/TG	24 3/8" x 20 7/8" x 16 3/8"	94.5	lbs.

**TUBES, CRYSTALS, TRANSISTORS:**

**REFERENCE DATA AND LITERATURE:**

TM 11-2235.  
(USA) 71-3364.

PUBLIC ADDRESS SET  
AN/PIP-1A

25 November 1958

Cog. Serv.: USA FSN: 5830-644-4413

USA Line Item No: 633440

	USA	USN	USAF	USMC
STATUS OR TYPE CLASS.:		Used by	L/Std	

Manufacturer: Audio Equipment Co, Inc.

**FUNCTIONAL DESCRIPTION:**

Public Address Set AN/PIP-1A is a compact and portable instrument which may be used in the same way as an ordinary megaphone. The set is designed for intermittent operation. It amplifies and transmits intelligible speech over extended distances through high ambient noise levels.

A total operating cycle of 2 hours at 50 percent on and 50 percent off is available from the fully charged battery. However, continuous operation for more than 10 minutes may overheat and thus damage the vibrator power supply. Each operating period should be followed by an equal deenergizing period.

This equipment is directly interchangeable, electrically and mechanically, with Public Address Set AN/PIP-1.

**RELATIONSHIP TO SIMILAR EQUIPMENT:**

**PUBLIC ADDRESS SET  
AN/PIP-1A**

**TECHNICAL DESCRIPTION:**

*Loudspeaker-Microphone:*

Type: A pressure-operated magnetic controlled reluctance microphone element.  
Impedance: 1,600 ohms.

*Remote Microphone:*

Type: A pressure-operated magnetic controlled reluctance microphone element.  
Impedance: 1,600 ohms.

*Audio Amplifier:*

Frequency Response: 400 cps to 5,500 cps.  
Stages: 3, push-pull.  
Output: 10 w.

*Loudspeaker:* A driver mechanism coupled to a horn.

*Power Requirement:* 6 v (Battery BB-207/U).

*Major Components:*

1	Audio-Frequency Amplifier AM-568A/PIP-1	6 1/2" x 10 1/2" x 12"	20	lbs.
1	Loudspeaker-Microphone LS-183A/PIP-1	6" x 13 1/2" x 13 3/4"	5.25	lbs.

**TUBES, CRYSTALS, TRANSISTORS:**

**REFERENCE DATA AND LITERATURE:**

NAVSHIPS 365-2035.

PUBLIC ADDRESS SET  
AN/PIQ-1

1 March 1964

Cog. Serv.: USA FSN: 5830-164-6620

USA Line Item No: 633450

	USA	USN	USAF	USMC
STATUS OR TYPE CLASS.:	Std C			

Manufacturer:

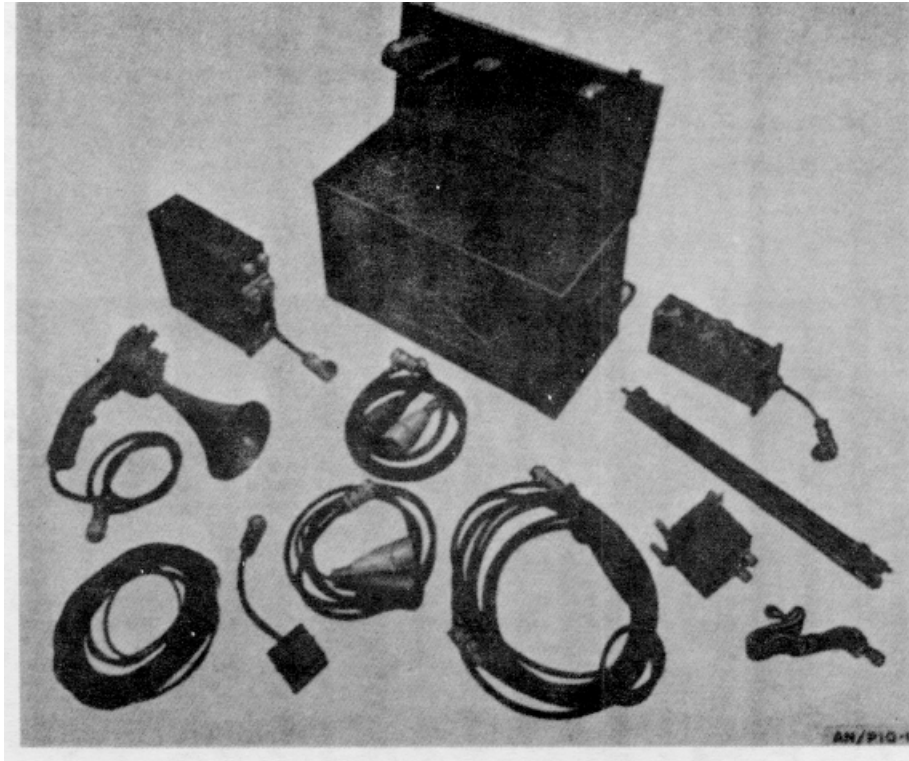
**FUNCTIONAL DESCRIPTION:**

Public Address Set AN/PIQ-1 is a portable (man-carried), low-power, short-range, voice amplifying and projecting equipment used by tactical or training units to control or brief groups of personnel within 200 yards of the set.

This equipment can be arranged for operation with the loudspeaker mounted on a handle supporting a lip microphone or it may be mounted on a tripod for stationary use. By means of auxiliary equipment, this set can be modified to allow the operator's hand to remain free while using the equipment.

The set can be installed and operated in a vehicle and connected to a larger loudspeaker; also it can be operated by a direct current power supply.

Earlier models are designed to hold three rechargeable wet cells in the battery tray; later models can accommodate either wet or dry cell batteries.

**RELATIONSHIP TO SIMILAR EQUIPMENT:**

**PUBLIC ADDRESS SET  
AN/PIQ-1**

**TECHNICAL DESCRIPTION:**

*Facilities:* Single-channel public address; voice.

*Type Controls:* Volume; push-to-talk switch.

*Power Output:* 1 1/2 w.

*Power Requirements:* 3 Batteries BB-206/U (storage) or 3 Batteries BA-56 and 4.

Batteries BA-41 (in emergency, Battery BA-30 may be substituted for Battery BA-41).

*Major Units:*

1	Amplifier AM-74/PIQ-1	2 1/4" x 8 1/4" x 4"	3.4	lbs.
1	Loudspeaker LS-110/PIQ-1	5" x 10 3/4"	1.75	lbs.
1	Microphone M-8/PIQ-1	3 1/8" x 3 1/2" x 10 1/4"	.90	lbs.
1	Tripod MT-353/PIQ-1	1 5/8" x 18" x 58"	2.25	lbs.

**TUBES, CRYSTALS, TRANSISTORS:**

**REFERENCE DATA AND LITERATURE:**

TM 11-2566.

17-3163.

PUBLIC ADDRESS SET  
AN/PIQ-2

1 March 1964

Cog. Serv.: USA FSN: 5830-164-7332

USA Line Item No: 633460

	USA	USN	USAF	USMC
STATUS OR TYPE CLASS.:			Std	

Manufacturer:

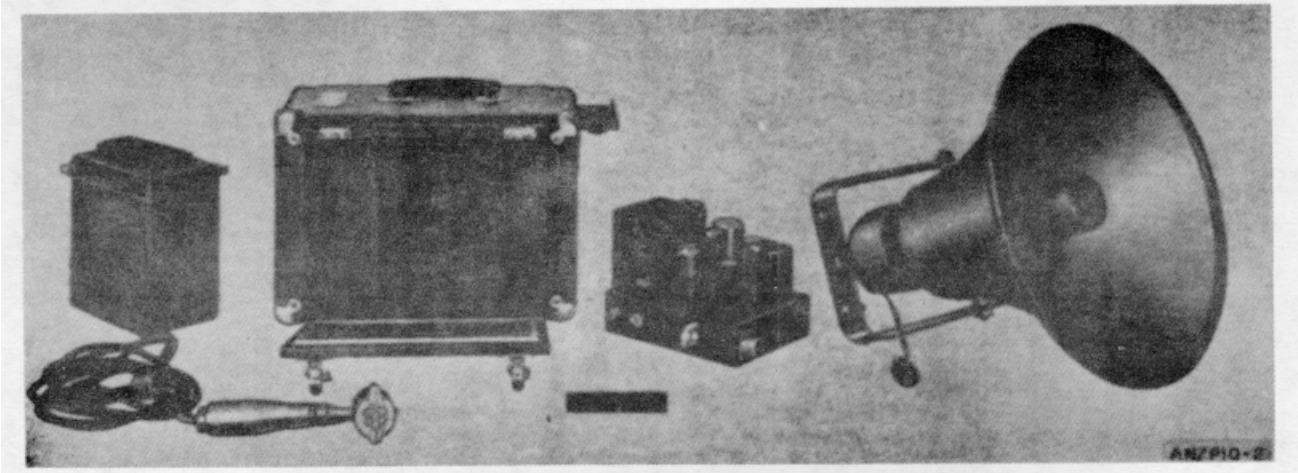
**FUNCTIONAL DESCRIPTION:**

Public Address Set AN/PIQ-2 is a portable, medium-power, general-purpose sound amplification and projection equipment used for beach control purposes during amphibious operations. It also may be used to control personnel in similar tactical operations.

The operating range of this equipment is approximately 300 to 400 yards.

Primarily, this set is designed for use where 10-volt alternating current power is not available. For power, a 6-volt storage battery is included in a specially designed container.

**RELATIONSHIP TO SIMILAR EQUIPMENT:****TECHNICAL DESCRIPTION:**

*Facilities:* Single-channel public address; voice.

*Type Control:* On-off switch; volume control.

*Power Output:* 10 to 14 w.

*Power Requirements:* 6-v dc.

*Major Units:*

- 1 Audio Amplifier.
- 1 Hand Microphone.
- 1 Loudspeaker.

**TUBES, CRYSTALS, TRANSISTORS:****REFERENCE DATA AND LITERATURE:**

PUBLIC ADDRESS SET  
AN/PIQ-5

15 March 1962

Cog. Serv.: USA FSN: 5830-688-6633

USA Line Item No: 633480

	USA	USN	USAF	USMC
STATUS OR TYPE CLASS.:	Std A			Std

Manufacturer: CCNP (91505)

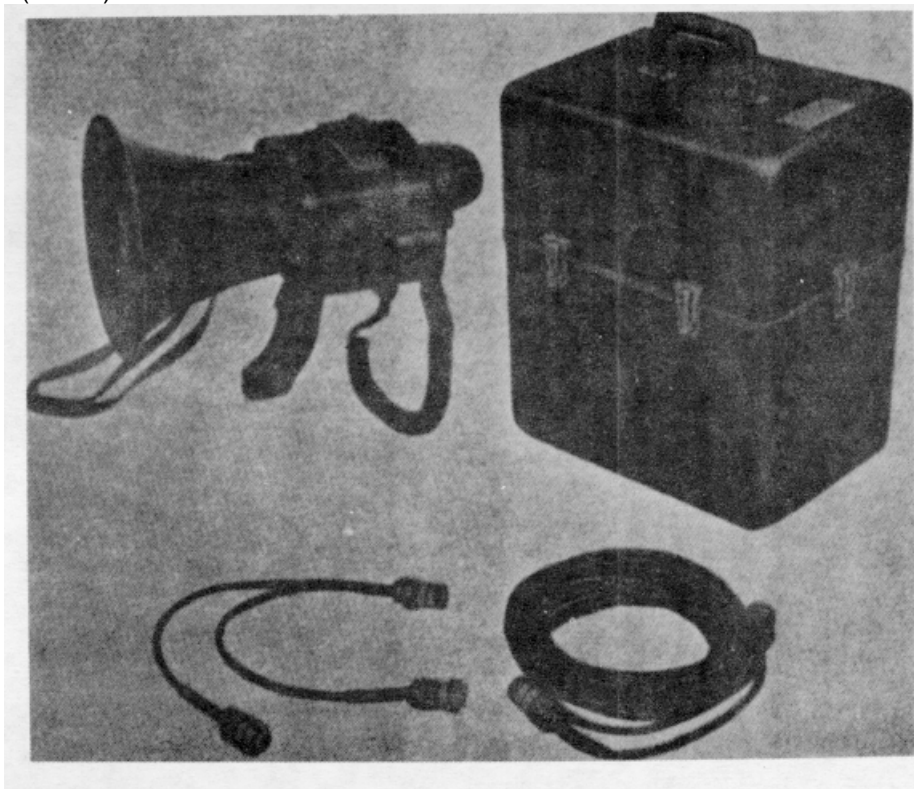
**FUNCTIONAL DESCRIPTION:**

Public Address Set AN/PIQ-5 is a power megaphone which may be used as a field public address system. The set comes with a detachable microphone and an extension cord.

**RELATIONSHIP TO SIMILAR EQUIPMENT:**

None.

**TECHNICAL DESCRIPTION:**

*Output:* 15 w with less than 10 percent distortion.

*Self-contained Power Source:* Ten BA-30 batteries.

*Weight:* 8.75 pounds with batteries.

*Case:* Watertight transit case.

*Shipping Data.*

Size: 15" x 15" x 15".

Weight: 15 pounds.

*Major Units:*

**PUBLIC ADDRESS SET  
AN/PIQ-5**

**TUBES, CRYSTALS, TRANSISTORS:**

**REFERENCE DATA AND LITERATURE:** None.



**SOUND RECORDER-REPRODUCER**  
**AN/PNH-type**  
**RD-31A/U**

1 March 1964

Cog. Serv.: USA FSN: 5835-170-4850

USA Line Item No: 658950

	USA	USN	USAF	USMC
<b>STATUS OR TYPE CLASS.:</b>	Std A	Used by	Std	

Manufacturer: General Electric Co.

No illustration available

**FUNCTIONAL DESCRIPTION:**

Sound Recorder-Reproducer RD-31A/U is a self-contained, portable, magnetic steel wire recorder and reproducer which records speech or music from a microphone, telephone, or program line source. Recordings may be played back immediately through this equipment's self-contained loudspeaker or through an external loudspeaker or headset. The equipment can be used as a public address set to cover a limited area with the self-contained speaker or to cover a large area with an external speaker (not supplied with equipment).

**RELATIONSHIP TO SIMILAR EQUIPMENT:****TECHNICAL DESCRIPTION:***Frequency Response:* 150 to 5,000 cps at  $\pm 3$  db.*Power Output:* 5 w.*Recording-Reproducing Medium:* Stainless steel wire.*Recording Time:* 60 min. max.*Wire Speed:* 2 1/2 ft per second.*Wire Size:* 0.004 inch diameter.*Recorder-Reproducer Head:*

Type: Magnetic

Impedance: 800 ohms at 1 kc; 890 ohms erase-coil impedance at 40 kc.

*Loudspeaker:*

Type: Permanent magnet.

Cone dia.: 5 inch.

*Output Transformer Impedance:* Primary, 5,000 ohms; secondary, 3.5 ohms.*Microphone:*

Type: Dynamic

Impedance: 30,000 ohms.

*Motor:*

Horsepower: 1/100

Rotation: 1,600 rpm.

*Power Requirements:* 100 w 105/120-v 60 cy ac.*Major Units:*

1 Microphone.

1 Sound Recorder-Reproducer, RD-31A/U

10 3/8" x 12 13/16" x 13 3/4"

32 lbs.

**TUBES, CRYSTALS, TRANSISTORS:****REFERENCE DATA AND LITERATURE:**

TM 11-2548.  
 (USA) 71-33477.

RADIO SET  
AN/PRC-6( )

1 March 1964

Cog. Serv.: USA FSN: 5820-194-9928

USA Line Item No: 643500

	USA	USN	USAF	USMC
STATUS OR TYPE CLASS.:	Std A		Std	

Manufacturer:

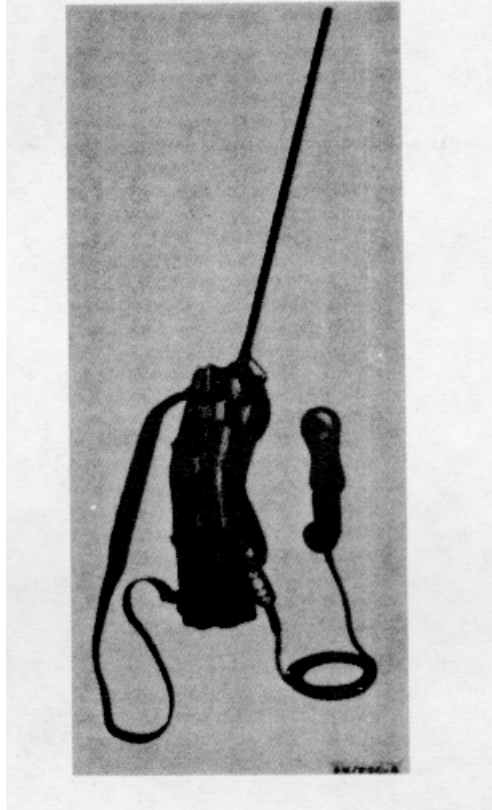

#### FUNCTIONAL DESCRIPTION:

Radio Set AN/PRC-6( ) is the fm version of the "handietalkie" Radio Set SCR-536 and operates in a single fixed-frequency channel selected by use of the appropriate crystal. This is a low-power, short-range equipment that operates in the vhf range for line-of-sight communication by forward elements of armored, infantry, and artillery units.

This equipment consists of a light, self-contained receiver-transmitter having a built-in microphone and earphone, and provision for a loop antenna that is used for homing applications. It includes provision for connecting a conventional handset. The entire set, with battery installed, weighs 6.5 pounds.

The normal antenna is a built-in spring-steel ribbon extending from or retracting into the housing.

It operates from Battery BA-270/U (which is not supplied as part of this set) and includes the necessary crystal unit for the frequency on which the equipment is to operate.

#### RELATIONSHIP TO SIMILAR EQUIPMENT:

**RADIO SET**  
**AN/PRC-6( )**

**TECHNICAL DESCRIPTION:**

*Frequency Range in mc:* 47.0 to 55.4.

*Type Modulation:* fm.

*Type of Signal:* Voice.

*Power Output:* 025 w.

*Power Requirements:* Battery BA-270/U.

Transmitter: 1 amp at 1.5-v dc (1.6 w); 14 ma at 45-v dc (0.63 w); 28 ma at 90-v de (2.52 w).

Receiver: 440 ma at 1.5-v dc (0.66 w); 13 ma at 45-v dc (0.585 w).

*Major Units:*

1	Crystal Unit CR-23/U	11/32" x 23/32" x 1 1/32"	0.031	lbs.
1	Handset H-33C/PT	1 1/2" x 8 3/8" x 3 1/4"	.875	lbs.
1	Radio Receiver-Transmitter RT-196/PRC-6	14 3/4" x 4 3/4" x 4 1/4"	3.5	lbs.

**TUBES, CRYSTALS, TRANSISTORS:**

**REFERENCE DATA AND LITERATURE:**

TM 11-296, TM 11-4069.

MIL-R-10250.

RADIO SET  
AN/PRC-8

1 March 1964

Cog. Serv.: USA FSN: 5820-253-6129

USA Line Item No: 643600

	USA	USN	USAF	USMC
STATUS OR TYPE CLASS.:	Std B	Std		

Manufacturer: Western Electric Co, Inc.

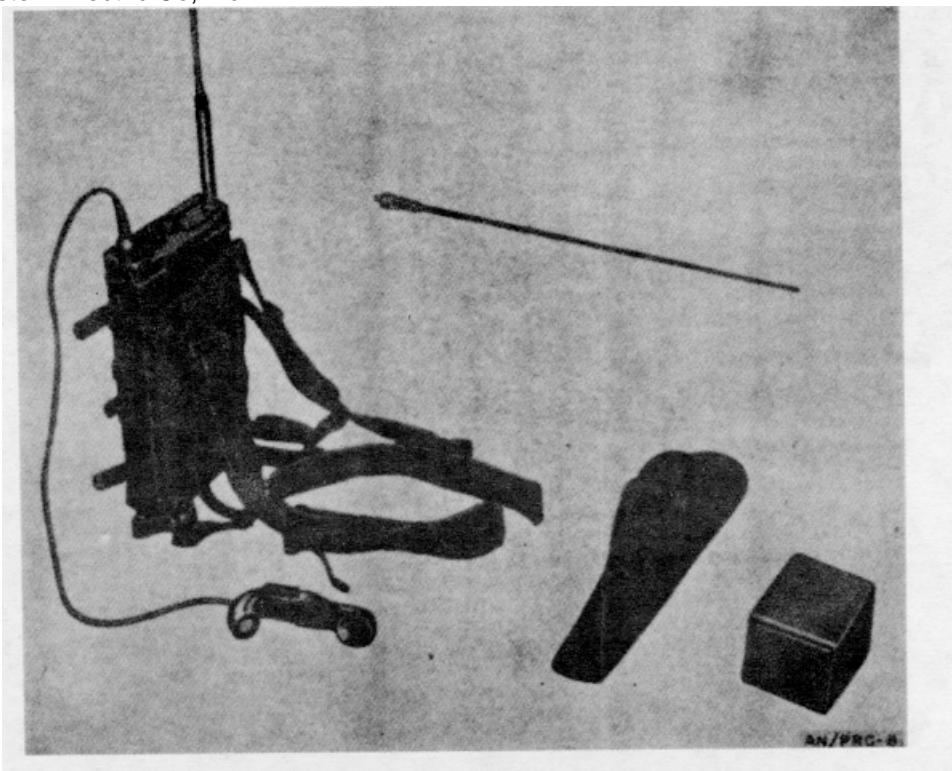
**FUNCTIONAL DESCRIPTION:**

Radio Set AN/PRC-8 is a portable (man-carried), low-power, fm (voice), radio transmitting and receiving equipment used for short-range, point-to-point, or radio relay communication in the frequency range assigned to armored divisions. It can also be installed in aircraft.

This equipment consists essentially of a radio transmitter-receiver equipped with a carrying harness, antenna components, and related accessories.

It can be operated by remote control and adapted for homing use by the addition of appropriate auxiliary components. The set can also be operated in a vehicle.

Two of these sets can be operated back-to-back as an unattended radio-relay station.

**RELATIONSHIP TO SIMILAR EQUIPMENT:**

**RADIO SET  
AN/PRC-8**

**TECHNICAL DESCRIPTION:**

*Frequency Range in mc:* 20.0 to 27.9.

*Type Modulation:* fm.

*Type of Signal:* Voice.

*Power Output:* 1.2 w.

*Power Requirements:* Battery BA-279/U (not supplied with set).

*Major Unit:*

1	Radio Receiver-Transmitter RT-174/PRC-8	9.5" x 3" x 10.5"	9 lbs.
---	---	-------------------	--------

**TUBES, CRYSTALS, TRANSISTORS:**

**REFERENCE DATA AND LITERATURE:**

TM 11-612, TM 11-4065.

MIL-R-10273B.

RADIO SET  
AN/PRC-9( )

1 March 1964

Cog. Serv.: USA FSN: 5820-254-9394

USA Line Item No: 643700

	USA	USN	USAF	USMC
STATUS OR TYPE CLASS.:	Std B	Used by	Std	

Manufacturer: Western Electric Co, Inc.

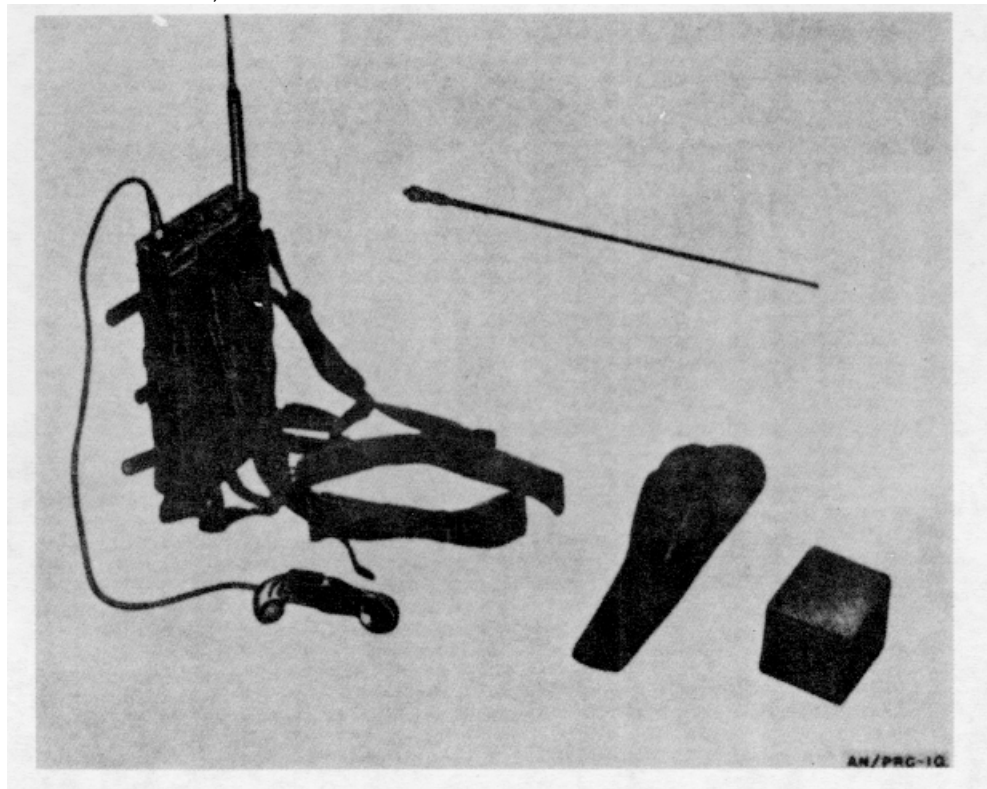
**FUNCTIONAL DESCRIPTION:**

Radio Set AN/PRC-9( ) is a portable (man-carried), low-power, fm (voice), radio transmitting and receiving equipment used for vhf, short-range, point-to-point, or radio-relay communication in the frequency range assigned to artillery units. It can also be installed and operated in aircraft or motor vehicle.

This equipment consists essentially of a radio receiver-transmitter equipped with a carrying harness, antenna components, and related accessories.

It can be operated by remote control and adapted for homing use by the addition of appropriate auxiliary components.

Two of these sets can be operated back-to-back as an unattended radio-relay station.

**RELATIONSHIP TO SIMILAR EQUIPMENT:**

**RADIO SET**  
**AN/PRC-9( )**

**TECHNICAL DESCRIPTION:**

*Frequency Range in Mc:* 27.0-38.9.

*Type Modulation:* fm.

*Type of Signal:* Voice.

*Power Output:* 1 w.

*Power Requirements:* Battery BA-279/U (not supplied with equipment).

*Major Unit:* 1 Radio Receiver-Transmitter RT-175/PRC-9                      9 1/2" x 3" x 10 1/2"                      9 lbs.

**TUBES, CRYSTALS, TRANSISTORS:**

**REFERENCE DATA AND LITERATURE:**

TM 11-612.

MIL-R-10273B.

**RADIO SET  
AN/PRC-10( )**

1 March 1964

Cog. Serv.: USA FSN: 5820-223-5122

USA Line Item No: 643800

	USA	USN	USAF	USMC
<b>STATUS OR TYPE CLASS.:</b>	Std A	Used by	Std	

**Manufacturer:**

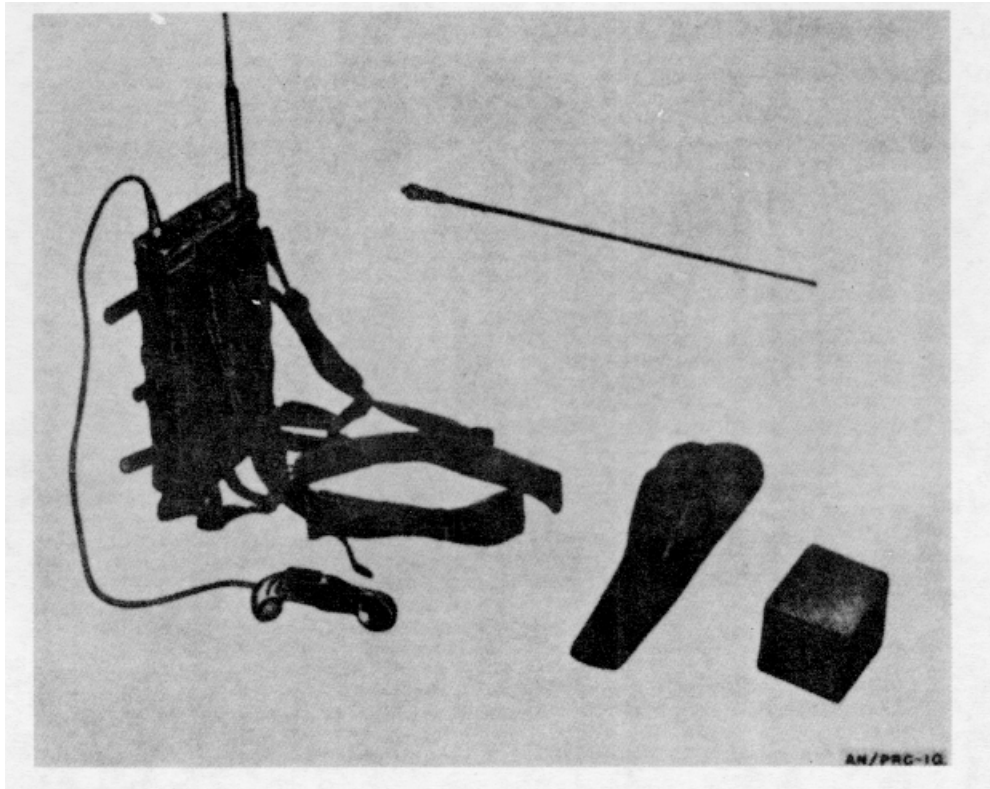

**FUNCTIONAL DESCRIPTION:**

Radio Set AN/PRC-10( ) is a portable (man-carried), low-power, fm (voice), radio transmitting and receiving equipment used for vhf, short-range, point-to-point, or radio-relay communication in the frequency range assigned to infantry divisions. It can also be installed and operated in aircraft or motor vehicles.

This equipment consists essentially of a radio receiver-transmitter equipped with a carrying harness, antenna components, and related accessories.

It can be operated by remote control and adapted for homing use by the addition of appropriate auxiliary components.

Two of these sets can be operated back-to-back as an unattended radio-relay station.

**RELATIONSHIP TO SIMILAR EQUIPMENT:**



**RADIO SET  
AN/PRC-10( )**

**TECHNICAL DESCRIPTION:**

*Frequency Range in Mc:* 38.0 to 54.9.

*Type Modulation:* fm.

*Type of Signal:* Voice.

*Power Output:* 0.9 w.

*Power Requirements:* Batter BA-279/U (not supplied with equipment).

*Major Unit:* 1 Radio Receiver-Transmitter RT-176/PRC-10                      9 1/2 x 3" x 10.5"                      9 lbs.

**TUBES, CRYSTALS, TRANSISTORS:**

**REFERENCE DATA AND LITERATURE:**

TM 11-612.

MIL-R-10273B.

RADIO SET  
AN/PRC-21( )

1 March 1964

Cog. Serv.: USA FSN: 5820-536-3320

USA Line Item No: 644290

	USA	USN	USAF	USMC
STATUS OR TYPE CLASS.:	Std A		L/Std	

Manufacturer: Motorola, Inc.

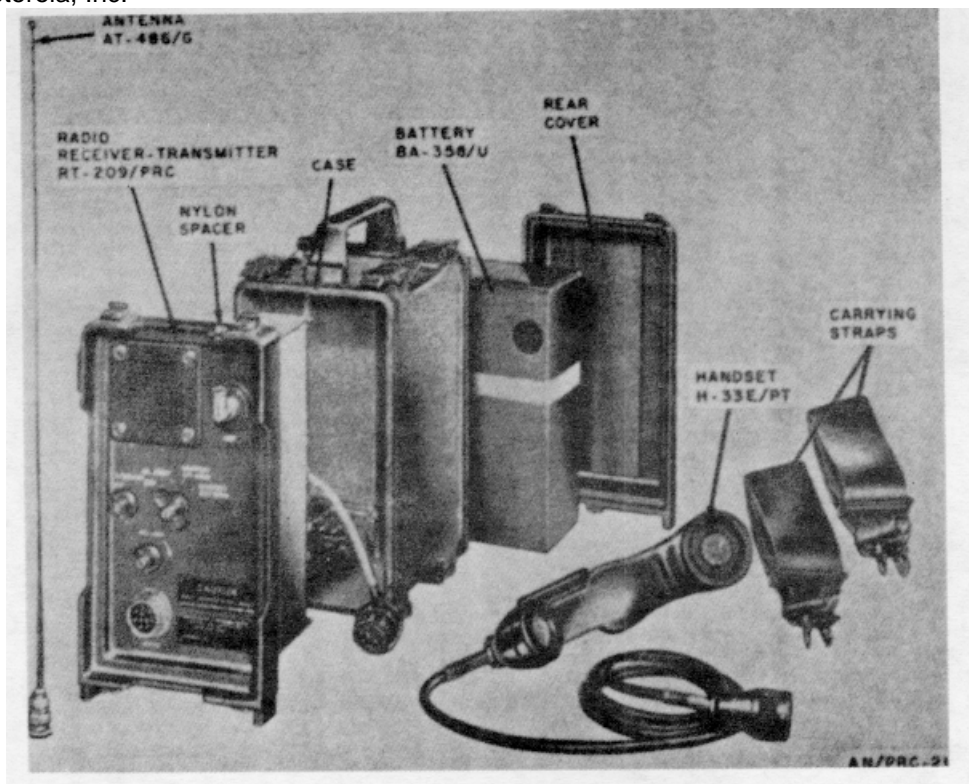
**FUNCTIONAL DESCRIPTION:**

Radio Set AN/PR-21( ) is a low-power, portable, fm transmitter-receiver used by military police, guards, and security forces.

This equipment consists essentially of a radio transmitter-receiver, handset, antenna, and carrying straps. It is powered by a dry battery that is not supplied with the equipment.

This set is intended for nontactical purposes.

**RELATIONSHIP TO SIMILAR EQUIPMENT****TECHNICAL DESCRIPTION:**

*Frequency Range in Mc:* 152 to 174.

*Type Modulation:* fm.

*Type of Signal:* Voice.

*Power Output:* 150 mw.

*Power Requirements:* Battery BA-358/U.

**RADIO SET  
AN/PRC-21( )**

*Major Unit:*

1 Radio Set AN/PRC-21( )

(Equipment consists of a single major operating assembly).

**TUBES, CRYSTALS, TRANSISTORS:**

**REFERENCE DATA AND LITERATURE:**

TM 11-610.

TO 31R2-2PRC21-11.

MIL-R-14028.

RADIO SET  
AN/PRC-3725 November 1958  
Cog. Serv.: USA FSN: 5820-  
USA Line Item No:

	USA	USN	USAF	USMC
STATUS OR TYPE CLASS.:			L/Std	

Manufacturer:

No illustration available

**FUNCTIONAL DESCRIPTION:**

Radio Set AN/PRC-37 is a portable, lightweight communication unit generally used by air-police and air-rescue teams. It is a single band, transistorized set with an operational range of 70 to 80 miles at an 8,000-foot altitude in air-rescue operations.

This equipment essentially replaces Radio Set AN/PRC-21.

**RELATIONSHIP TO SIMILAR EQUIPMENT:****TECHNICAL DESCRIPTION:**

*Frequency Range in Mc:* 144 to 174.

*Number of Bands:* 1.

*Type of Modulation:* fm

*Type Emission:* F3 (voice).

*Power Output:* 1 w (max).

*Power Requirements:* 6- or 12-v battery (rechargeable).

*Major Units:*

- 1 Power supply.
- 1 Radio receiver.
- 1 Radio transmitter.

**TUBES, CRYSTALS, TRANSISTORS:****REFERENCE DATA AND LITERATURE:**

**RADIO SET  
AN/PRC-41(XN-2)**

15 March 1962

Cog. Serv.: USA FSN:

USA Line Item No: -41-645700

	USA	USN	USAF	USMC
<b>STATUS OR TYPE CLASS.:</b>	Std B	P/Std	T/Std	

Manufacturer: COL (13499).

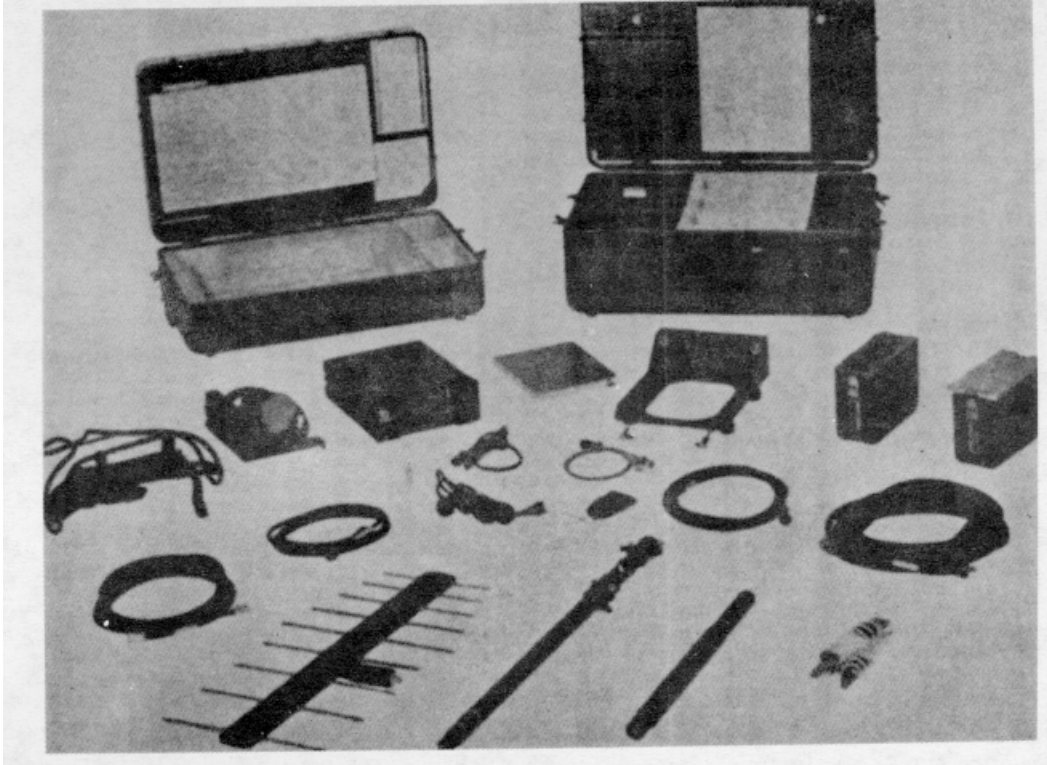
**FUNCTIONAL DESCRIPTION:**

Radio Set AN/PRC-41(XN-2) is a lightweight, portable uhf transceiver which may be used for man-pack, vehicular, or fixed station operations. The radio set provides amplitude modulated (am) communications on any one of 1, 50 channels spaced 100 kilocycles apart in the frequency range of 225.0 to 399.9 megacycles. All controls, including the frequency selector knobs, are an integral part of the waterproof receiver-transmitter unit. Automatic relay operation is provided when two receiver-transmitter units are used together. For man-pack operation, a 26.5-volt waterproof battery attached to the receiver-transmitter unit provides primary power. For vehicular operation, power is provided by the 26.5-volt vehicle battery. A 115/230-volt ac to 26.5-volt dc converter power supply is provided for fixed station operation.

**RELATIONSHIP TO SIMILAR EQUIPMENT:****TECHNICAL DESCRIPTION:**

*Frequency Range:* 225.0 to 399.9 mc.

*Channels:* 1750, spaced at 100-kc intervals.

**RADIO SET  
AN/PRC-41(XN-2)**

*Stability:*  $\pm 12$  kc.

*Duty Cycle:* 1 min transmit; 9 min receive.

*Type of Frequency Control:* Crystal.

*Power Requirements:* 26.5 v dc  $\pm 10$  percent, or 115/230 v ac  $\pm 10$  percent, 50 to 400 cps.

*Transmitter Data:*

Power Output: 3 w of unmodulated power into a 50-ohm load; power output independent of alt.

Modulation: am.

Modulation Sensitivity: Carbon microphone input of 1.0 v.

Modulation Capability: 100 percent (adjusted to clip between 70 to 90 percent).

Fidelity: +1 db, -3 db, 300 to 3500 cps.

Distortion: Less than 10 percent with modulation 3 db below clipping level.

*Receiver Data:*

Sensitivity: 3- $\mu$ v signal modulated 30 percent at 100 cps produces 20 mw at a signal-plus-noise to noise ratio of 10 db or greater.

Selectivity: 6 db -47 kc min; 60 db -120 kc max.

Images and Spurious Responses: 70 db down.

IF Rejection: 80 db down.

AVC Characteristics: Output within  $\pm 3$  db from 10 to 100,000  $\mu$ v.

Blocking: No blocking for input signals up to 0.5 v.

Squelch Operation: A change in audio output of at least 10 db is effected by a 1-db change in input signal.

Ultimate (S+N)/N Ratio: At least 35 db (measured at 1000  $\mu$ v).

Audio Output: 450 mw into a 300-ohm load with 90 percent modulation.

Audio Fidelity: +1, -3 db from 300 to 3500 cps.

Audio Distortion: Less than 10 percent at 50 mw output.

Guard Receiver Selectivity: 6-db -50-kc min; 60 db -200 kc max (complete separate receiver except for audio amplifier).

*Major Units:*

1	Radio Receiver-Transmitter Unit 1 of AN/PRC-41(XN-2).	13 3/4" x 11 1/16" x 4 5/16"	22.5	lbs.
1	DC Power Supply, Unit 2 of AN/PRC-41(XN-2)	7 3/8" x 10 3/4" x 4"	16	lbs.
1	AC Power Supply, Unit 3 of AN/PRC-41(XN-2)	7 1/2" x 10 3/4" x 5 1/4"	14.8	lbs.
1	Directional Antenna, Unit 4 of AN/PRC-41(XN-2).	31 1/2" x 10 1/4" x 1 3/4"	4.8	lbs.
1	Omnidirectional Antenna Unit 5 of AN/PRC-41(XN-2).	23 5/8" x 1 5/8" (dia.)	1.1	lbs.
1	Mounting, Unit 6 of AN/PRC-41(XN-2)	16 7/32" x 11 1/4" x 5 9/16"	2.4	lbs.
1	Electronic Equipment Case, Unit 7 of AN/PRC-41 (XN-2).	14 5/8" x 32 1/8" x 20 1/8"	60	lbs.
1	Antenna Mast, Unit 12 of AN/PRC-41 (XN-2)	28" x 2 1/2" (dia.)	2.63	lbs.
1	Electronic Equipment Case, Unit 13 of AN/PRC-41 (XN-2).	11 7/16" x 32 1/8" x 20 1/8"	47	lbs.
1	Mounting, Unit 14 of AN/PRC-41(XN-2)	10 3/4" x 5 1/4" x 3/8"	2.12	lbs.
1	Pack Harness and Rucksack Frame		4.5	lbs.
1	Handset H-33/PT		1.1	lbs.

**TUBES, CRYSTALS, TRANSISTORS:**

**REFERENCE DATA AND LITERATURE:**

NAVSHIPS 93714.

PORTABLE RADIOTRANSMITTING AND RECEIVING EQUIPMENT  
AN/PRC-type  
MAY-1

15 March 1962

Cog. Serv.: USA FSN: 5820-567-8846

USA Line Item No:

	USA	USN	USAF	USMC
STATUS OR TYPE CLASS.:		Obs		

Manufacturer: CRP 49956 Raytheon Company.

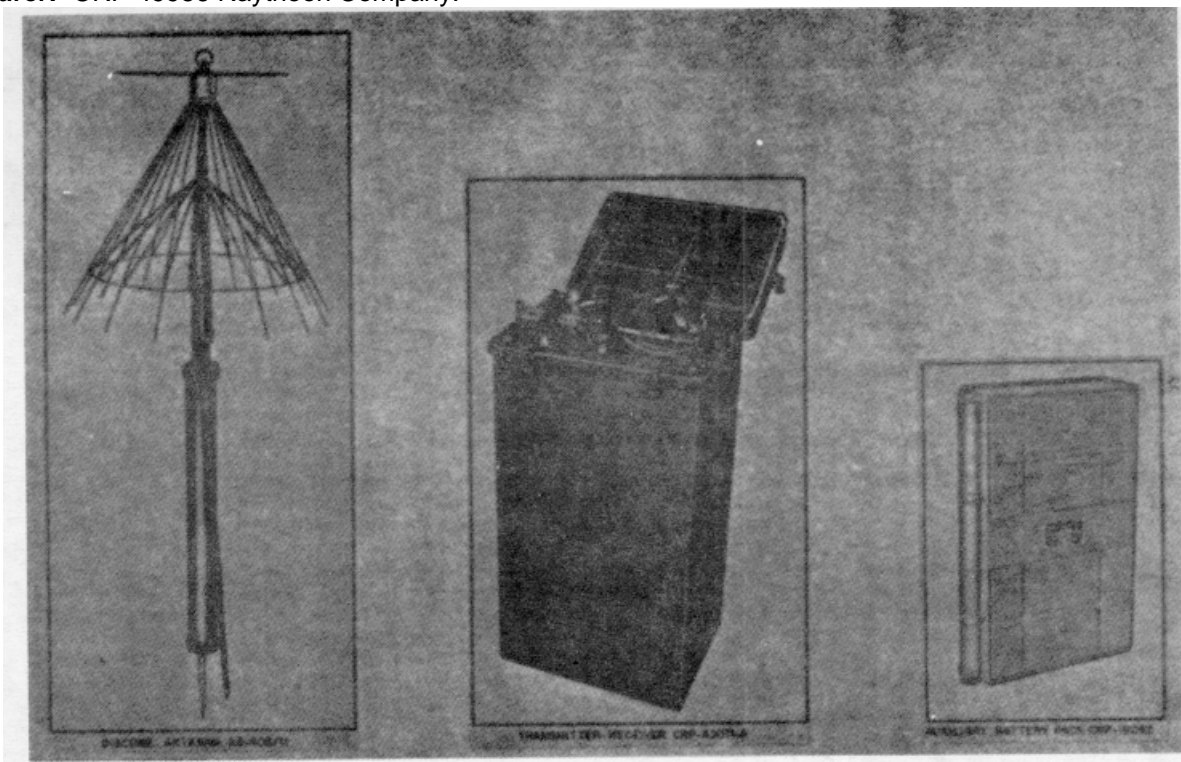

**FUNCTIONAL DESCRIPTION:**

Portable Radio Transmitting and Receiving Equipment, Navy Model MAY-1, is a two-way battery-operated field set, designed for packboard carry. This set provides voice or MCW communication on any one of four preset channels in the 225-390-mc frequency range.

The electrical design of the equipment is such that it complies with blackout requirements under all conditions of normal operation, while receiver radiation is attenuated more than 40 db below the normal transmitting power level.

The mechanical design of the equipment is such that it will maintain adjustment and provide normal operation during long periods of tropical service. The equipment is submergence proof, buoyant in fresh water, and present a low silhouette when carried by a man lying prone.

**RELATIONSHIP TO SIMILAR EQUIPMENT:**

**PORTABLE RADIO TRANSMITTING AND RECEIVING EQUIPMENT  
AN/PRC-type  
MAY-1**

**TECHNICAL DESCRIPTION:**

*Frequency range:* 225-390 mc.

*Type of frequency control:*

Transmitter: crystal-controlled, 4 preset frequencies.

Receiver: crystal-controlled, 4 preset frequencies.

*Types of emission:*

A3 (voice), am 90% modulation capability.

A2 (MCW), 850-1000 cy, 90% modulation capability.

*Normal carrier output:*

1 w into 50-ohm noninductive load (A2 or A3 emission).

*Type of receiver:*

Superheterodyne, 100-kc IF.

*Receiver Characteristics:*

Audio output: 25 mw into 300 ohms (phones).

Input impedance: 50 ohms (antenna).

Type of reception: A3 (voice) and A2 (MCW).

*Power Supply:*

Self-contained vibrator power supply.

*Primary power source:*

Self-contained 6v lead-acid battery.

*Crystals:*

Navy Type, CR-9/U quartz crystals, four each for transmitter and receiver, within  $\pm 0.005\%$  of nominal frequency over operating range of  $-55^{\circ}\text{C}$ . ( $-67^{\circ}\text{F}$ .) to  $90^{\circ}\text{C}$ . ( $194^{\circ}\text{F}$ .)

*Antennas:*

Telescopic arm antenna: vertically polarized.

Broad-band Discone Antenna.

Input impedance: 50 ohms.

SWR (voltage): less than 1.5 to-1 over the entire 225--390-mc range.

Polarization: vertical.

*Major Units:*

Transmitter-Receiver CRP-43071-A	10" x 13 1/8" x 23 13/16"	44 lbs.
1 Headset Assembly-49507		
1 Microphone Assembly-51071		
Auxiliary Battery Pack CRP-19062	5 1/2" x 11 7/8 x 20 5/8"	42 lbs.
Discone Antenna AS-408/U	2 5/16+" x 2 5/16+" x 20 9/16+"	2 3/4 lbs.

**EQUIPMENT REQUIRED BUT NOT SUPPLIED:**

2	Packboard, Plywood	Field transport of equipment	Army Stock No. 74-P-27-30.
2	Attachment, Packboard	Field transport of equipment	Army Stock No. 74-A-33-30.
1	Battery Charger	Recharging equipment batteries	Signal Corps Type RA-91. Marine Transportation Corps Allen Charger, or Battery Charger PP-367/U. To charge 6v storage battery at a rate not to exceed 4 amp.



PORTABLE RADIO TRANSMITTING AND RECEIVING EQUIPMENT  
AN/PRC-type  
MAY-1

**TUBES, CRYSTALS, TRANSISTORS:**

<i>Type</i>	<i>Quantity</i>
1007-----	1
1AG5-----	1
5656-----	5
5744WA-----	1
5654/6AK5W-----	<u>5</u>
Total -----	13

**REFERENCE DATA AND LITERATURE:**

Instruction Book NAVSHIPS 91792.  
+Folded dimensions.

**RADIO SET  
AN/PRC-type  
SCR-300**

1 March 1964

Cog. Serv.: USA FSN: 5820-186-9200

USA Line Item No: 652400

	USA	USN	USAF	USMC
STATUS OR TYPE CLASS.:	L/Std	Used by		

Manufacturer: Philco Corp.

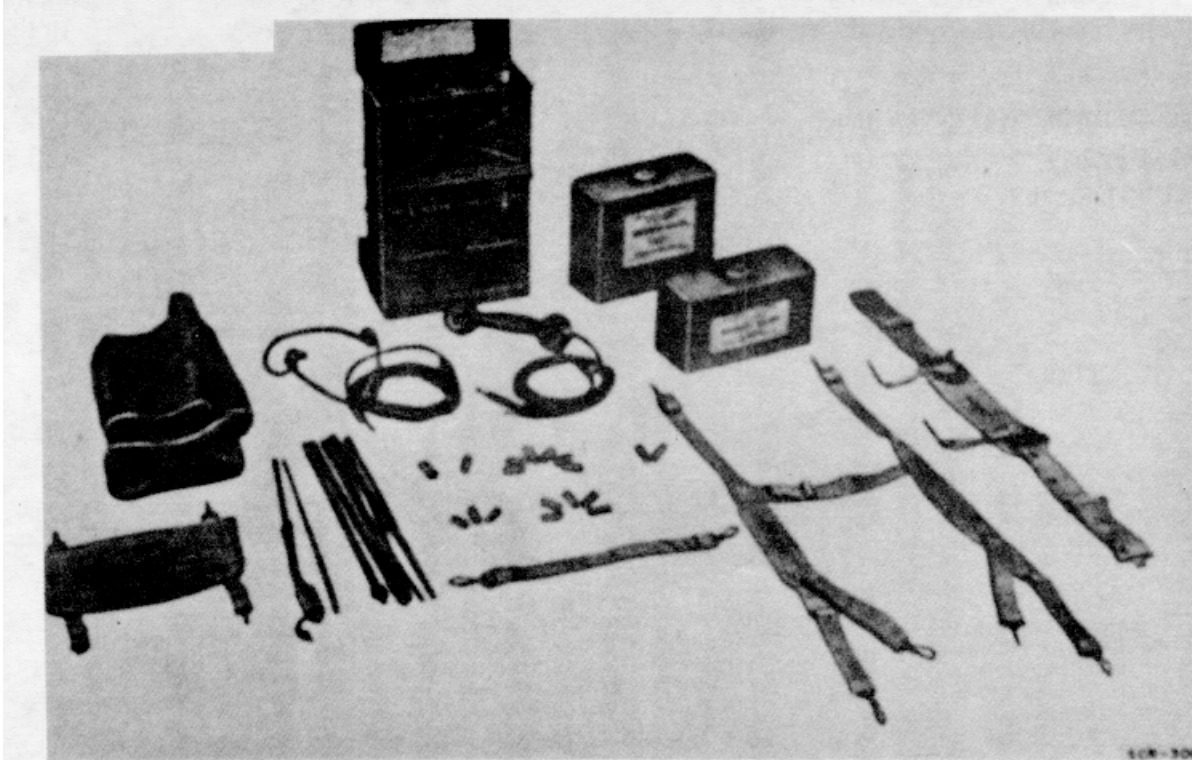

**FUNCTIONAL DESCRIPTION:**

Radio Set SCR-300 is a portable, short-range, low-power, fm (voice) transmitting and receiving equipment used for communication by foot troops.

This equipment consists of a transmitter-receiver contained in a metal housing, the lower portion of which is the battery compartment, and includes a flexible, whip-type antenna. It may be operated on the ground or while being carried by the operator or a "bearer" and may be installed in aircraft or vehicles. A handset with a press-to-talk switch is included but the equipment can be operated by means of headphones and microphone.

The vehicular version of this equipment is Radio Set AN/VRC-3.

**RELATIONSHIP TO SIMILAR EQUIPMENT:**

**RADIO SET**  
**AN/PRC-type**  
**SCR-300**

**TECHNICAL DESCRIPTION:**

*Frequency Range in Mc:* 40 to 48.

*Type Modulation:* fm.

*Type of Signal:* Voice.

*Power Output:* 0.3 w.

*Power Requirements:* Battery BA-80

*Major Units:*

1	Battery Case CS-139	9 3/8" x 10 15/16" x 7 1/4"	3.66 lbs.
1	Radio Receiver and Transmitter BC-1000	5 5/8" x 11 5/16" x 7 1/8"	13 lbs.

**TUBES, CRYSTALS, TRANSISTORS:**

**REFERENCE DATA AND LITERATURE:**

TM 11-242.

(USA)271-1601.

REMOTE CONTROL EQUIPMENT  
AN/PRW-type  
RC-261

1 March 1964

Cog. Serv.: USA FSN: 5820-228-6108

USA Line Item No: 660340

	USA	USN	USAF	USMC
STATUS OR TYPE CLASS.:	Std C			

Manufacturer:

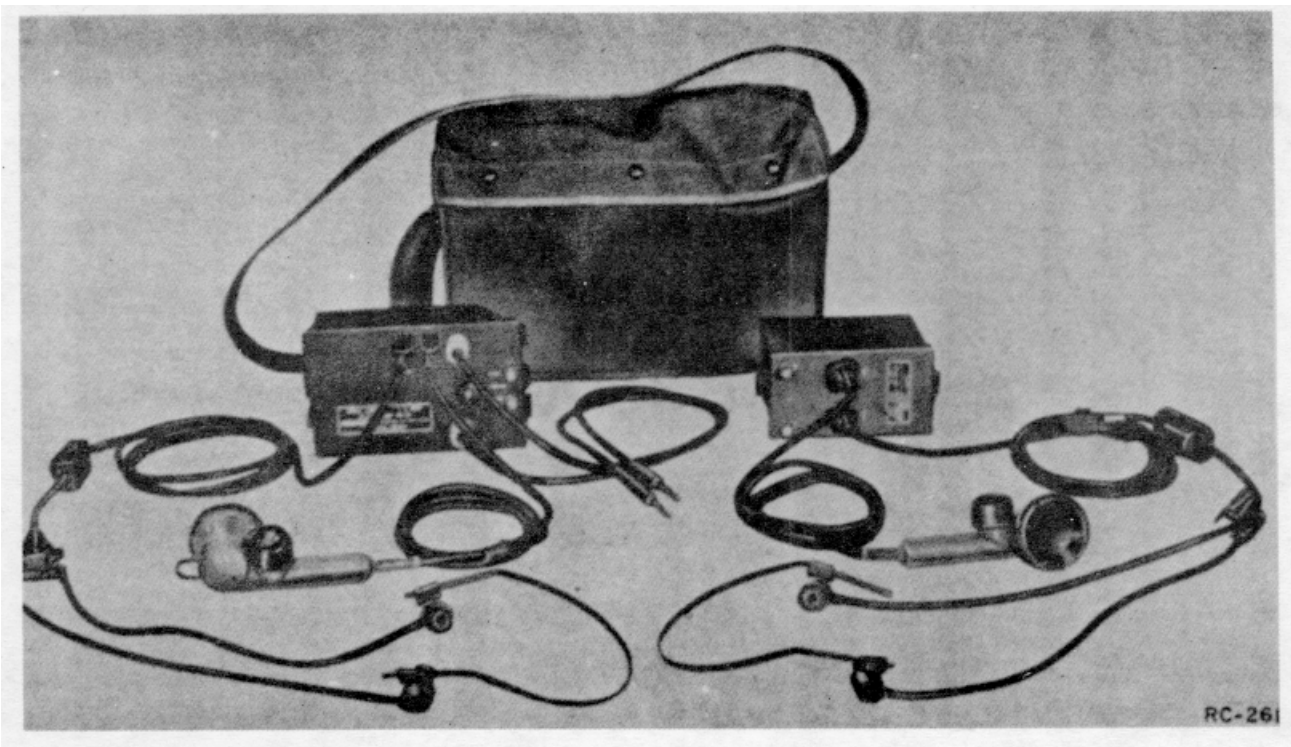
**FUNCTIONAL DESCRIPTION:**

Remote Control Equipment RC-261 is an assemblage of items enabling the erection of a local-battery telephone facility between a remote operating position and the actual site of a radio equipment.

This equipment consists essentially of a control station designed to be operated at the remote point, a control box used at the radio set, and accessories. The remote control unit may be connected to the control box at the radio set by field wire.

The equipment is powered by dry batteries and by the hand magneto unit, which is integral in the remote control unit.

**RELATIONSHIP TO SIMILAR EQUIPMENT:**

**REMOTE CONTROL EQUIPMENT**  
**AN/PRW-type**  
**RC-261**

**TECHNICAL DESCRIPTION:**

*Type of Signal:* Cw, voice.

*Type Communication Circuits:* Local battery telephone.

*Controls:* A switch marked RADIO, REMOTE, INTERPHONE; impedance switch marked HIGH-LOW; and press-to-talk switch.

*Power Requirements:* 3-v dc (two Batteries BA-30); 6-v dc (four Batteries BA-30).

*Major Units:*

1	Control Unit RM-3	8 1/2" x 4 3/8" x 4 3/8"	4.94 lbs.
1	Remote Control Unit RM-42	7 1/16" x 3 1/4" x 5 3/16"	3.5 lbs.

**TUBES, CRYSTALS, TRANSISTORS:**

**REFERENCE DATA AND LITERATURE:**

TM 11-2632.

AUDIO FREQUENCY MONITOR  
AN/PTA-1

1 March 1964

Cog. Serv.: USA FSN: 6625-668-9525

USA Line Item No: 627645

	USA	USN	USAF	USMC
STATUS OR TYPE CLASS.:	Std A			

Manufacturer:

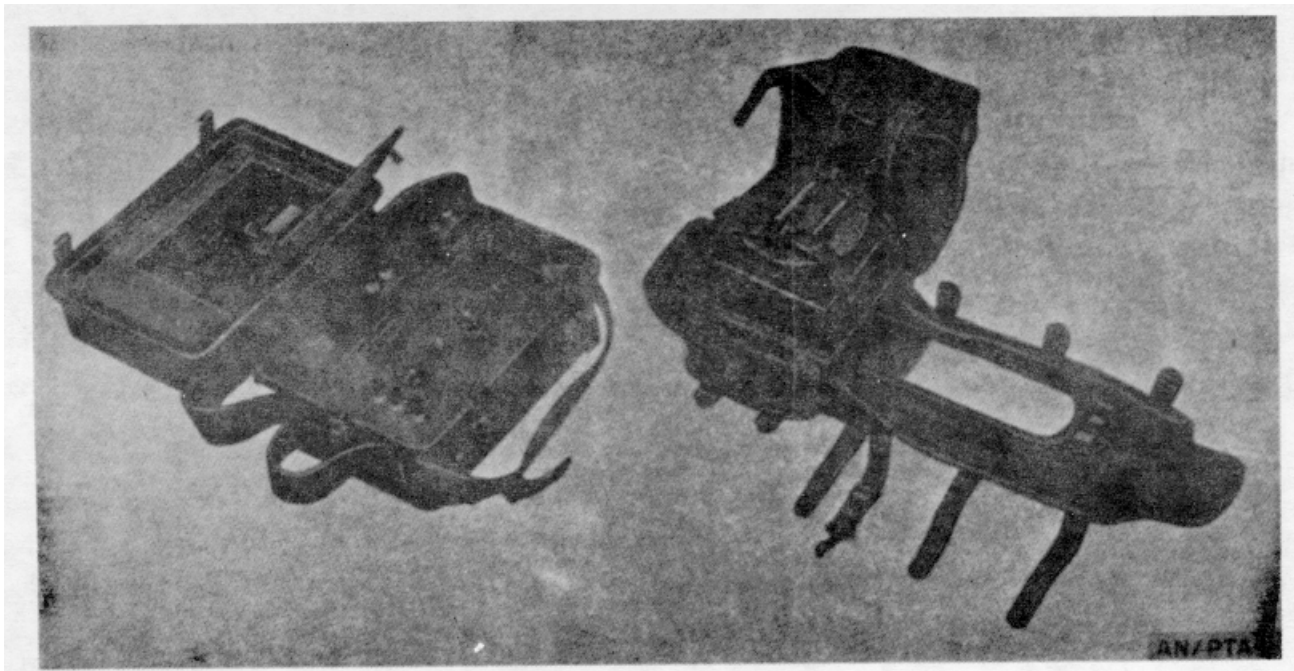
**FUNCTIONAL DESCRIPTION:**

Audio Frequency Monitor AN/PTA-1 is a battery-operated wire tapping device used in the interception of communication signals transmitted over telephone wire circuits.

The intercepted signal can be recorded, but recording equipment is not supplied as part of this assemblage.

For convenience, this equipment is packed in two units for transportation and can be easily carried by one man.

**RELATIONSHIP TO SIMILAR EQUIPMENT:****TECHNICAL DESCRIPTION:**

*Frequency Range:* 200 to 8,000 cps.

*Number of Band:* 1.

*Audio Frequency Amplifier AM-558/PTA-1:*

*Input Impedance:* 20; 150; 500; 1,000; 2,000; 3,500; 5,000; 500,000 ohms; a ninth impedance position labeled FOR DIRECT CONNECTION TO LINES is for wire line bridging use.

**AUDIO FREQUENCY MONITOR  
AN/PTA-1**

*Output Impedance:* 600 ohms.

*Input Impedance Accuracy:*  $\pm 10\%$ , FILTER switch B at 200 to 8,000 cps.

$\pm 20\%$ , FILTER switch B at 200 to 3,000 cps.

$\pm 20\%$ , FILTER switch B at 300 to 8,000 cps.

$\pm 25\%$ , FILTER switch B at 300 to 3,000 cps.

*Output Impedance Accuracy:*  $\pm 10\%$  at 1,000 cps.

*Amplifier Gain:* 90 db at 1,000 cps, minimum; 85 db between 200 and 8,000 cps.

*Power Output:* Plus 10 dbm.

*Distortion:* 7% (max) at max power.

*Power Requirement:* 6 v, 50-ma dc (fil); 90 v, 5-ma dc (p).

*Major unit:*

1 Amplifier, Audio Frequency AM-558/PTA-1.

8 3/4" x 10 5/8" x 15 3/8"

20 lbs.

**TUBES, CRYSTALS, TRANSISTORS:**

**REFERENCE DATA AND LITERATURE:**

TM 11-2099/TO16-30PTA1-6.

MIL-M-10670.

**MANUAL TELEPHONE SWITCHBOARD**  
**AN/PTC-type**  
**SB-22( )/PT**

1 March 1964

Cog. Serv.: USA FSN: 5805-257-3602

USA Line Item No: 672380

	USA	USN	USAF	USMC
<b>STATUS OR TYPE CLASS.:</b>	Std A		Std	

**Manufacturer:** Stromberg-Carlson Co, Division, General Dynamics Corp.

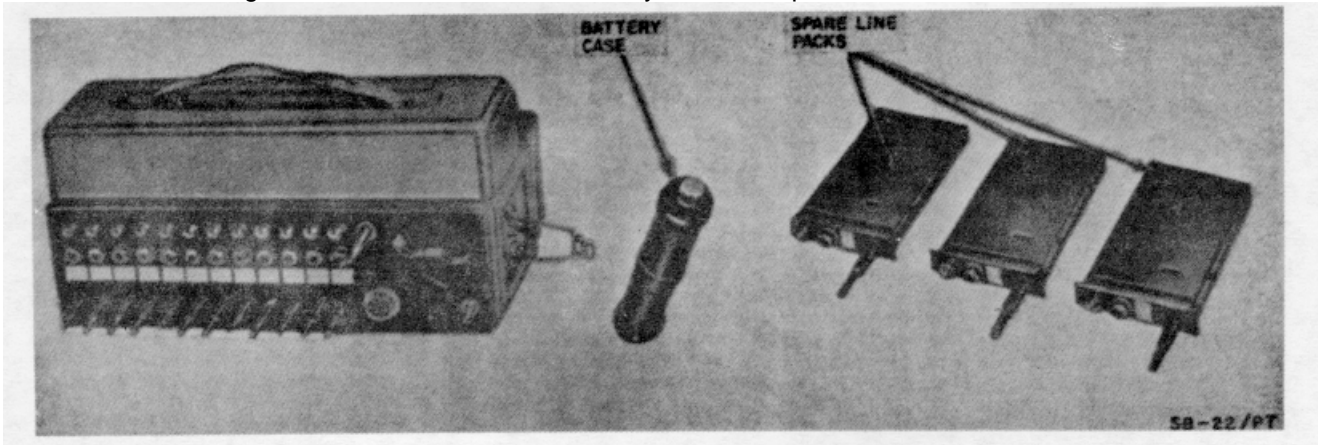
**FUNCTIONAL DESCRIPTION:**

Manual Telephone Switchboard SB-22( )/PT is a small, portable, 12-line monocord switchboard used to interconnect local-battery telephone lines and/or vf telegraph equipment.

This equipment consists essentially of a case in which individual line packs and an operator's pack are mounted. This method of design allows rapid replacement of defective circuits. The operator's pack includes a hand-generator for ringing.

Two of these equipments can be stacked and used together to handle 29 lines; in this application the operator's pack is removed from one case and replaced by five additional line packs.

**RELATIONSHIP TO SIMILAR EQUIPMENT:****TECHNICAL DESCRIPTION:**

*Number of Switchboard Position:* 1.

*Number and Type of Circuits:* 1 cord; 12 line.

*Power Requirements:* Four Batteries BA-30.

*Major Unit:* Switchboard SB-22/PT (bare unit).

12" x 12" x 16 5/16"

25 lbs.

**TUBES, CRYSTALS, TRANSISTORS:****REFERENCE DATA AND LITERATURE:**

TM 11-2202.

MIL-S-10399.



**MANUAL TELEPHONE SWITCHBOARD  
AN/PTC-type  
SB-86/P**

1 March 1964

Cog. Serv.: USA FSN: 5805-503-2660

USA Line Item No: 672390

	USA	USN	USAF	USMC
<b>STATUS OR TYPE CLASS.:</b>	Std A		Std	

**Manufacturer:** Kellogg Switchboard & Supply Co.  
North Electric Manufacturing Co.

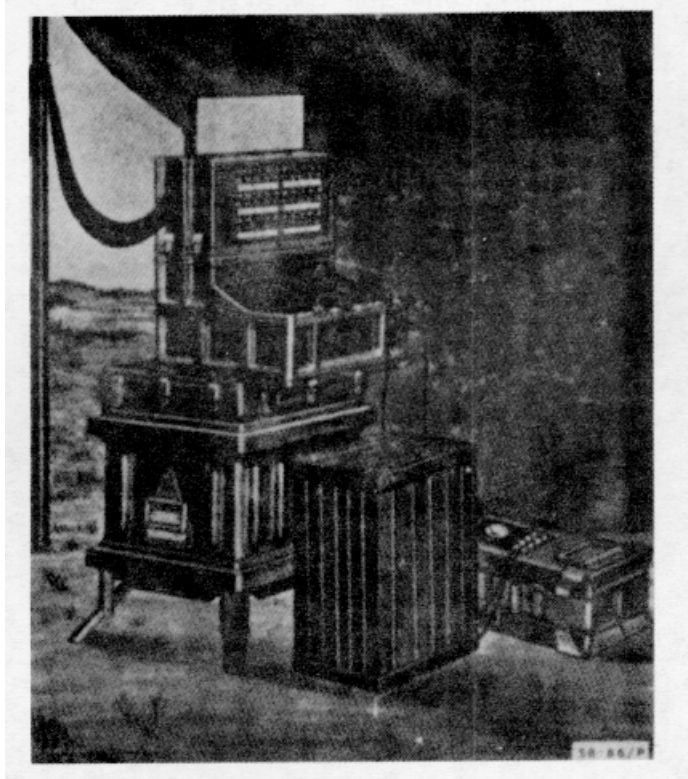

**FUNCTIONAL DESCRIPTION:**

Manual Telephone Switchboard SB-86/P is a portable, field-type unit used to connect local-battery telephone and voice-frequency teletypewriter lines in many types of wire communication systems.

This equipment is capable of handling 15 calls at a time. Provision is made for automatic and manual ringing, common-battery and magneto signaling, and conference calls. It is mounted for operation on its outer cover assembly. An additional jack field is required to handle more than 30 lines.

Telegraph Terminal TH-5/TG and a teletypewriter are required to complete calls if the vf teletypewriter circuits are set up for telegraph only service.

**RELATIONSHIP TO SIMILAR EQUIPMENT:**

**MANUAL TELEPHONE SWITCHBOARD**  
**AN/PTC-type**  
**SB-86/P**

**TECHNICAL DESCRIPTION:**

*Number of Switchboard Position:* 1.

*Number and Type of Circuits:* 16 cord, 30 line (expandable to 60 line with additional equipment), 2 trunk.

*Ringin:* 20 cps from vibrator or hand magneto.

*Power Requirements:*

Common Battery signaling: 20-26.5-v dc from five Batteries BA-200/U.

Magneto signaling: 15-26.5-v dc.

Night alarm and panel lamps: 3-v dc from two Batteries BA-30.

Operator's set: 3-v dc from two Batteries BA-30.

*Major Units:*

1	Manual Telephone Switchboard Section SB-248/P	21" x 23 1/2" x 18 1/2"	65 lbs.
1	Power Supply PP-990/G	10" x 21" x 7 1/8"	29 lbs.
1	Switchboard Signal Assembly TA-207/P	10" x 4" x 14 1/2"	6 lbs.

**TUBES, CRYSTALS, TRANSISTORS:**

**REFERENCE DATA AND LITERATURE:**

TM 11-2134.  
MIL-S-10446.

**SIGNAL LAMP EQUIPMENT**  
**AN/PVC-type**  
**SE-11**

1 March 1964

Cog. Serv.: USA FSN: 5840-407-6671

USA Line Item No: 665090

STATUS OR TYPE CLASS.:	USA	USN	USAF	USMC
	Std A			

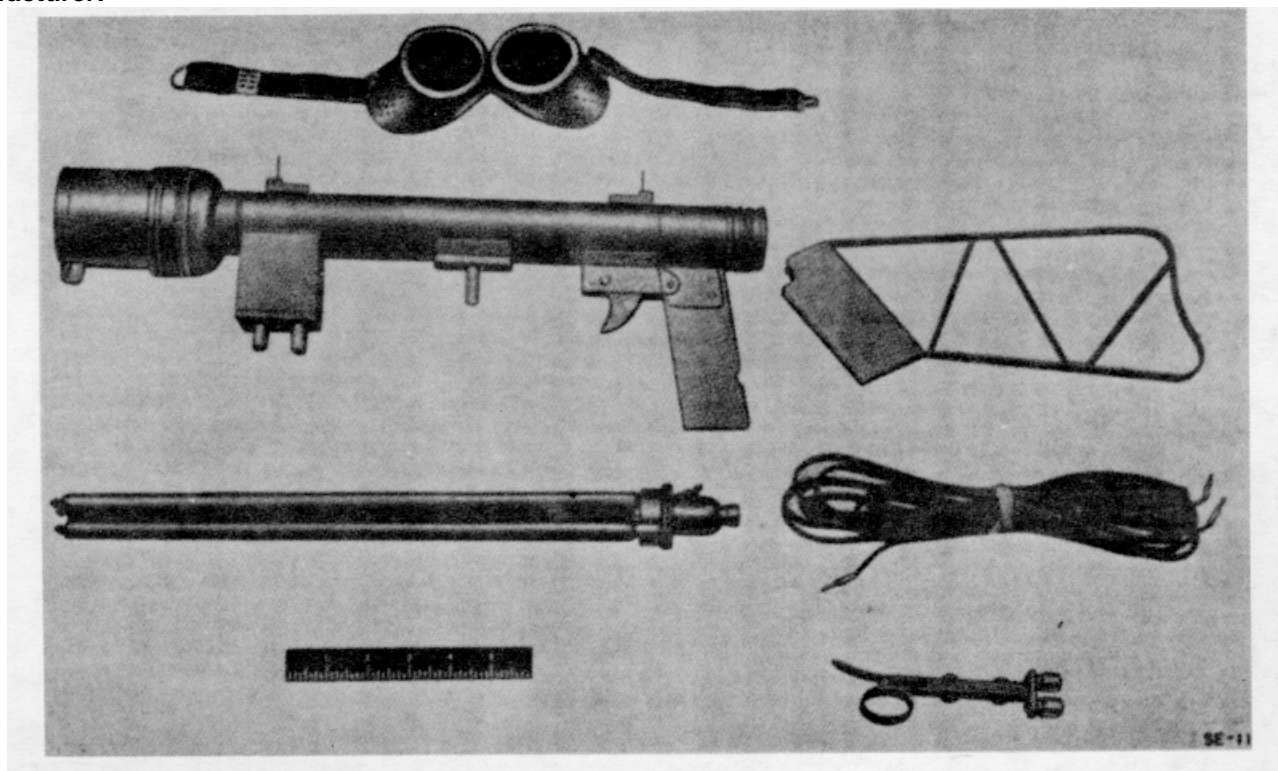
**Manufacturer:****FUNCTIONAL DESCRIPTION:**

Signal Lamp Equipment SE-11 is a light-signaling device used for visual communication. It is used in traffic control and in forward area line-of-eight communication applications.

This equipment consists essentially of a signal lamp with a pistol grip and trigger-type on-off switch. A gunstock type of mounting is provided for operating the equipment from the shoulder. A tripod is included for use when the signal lamp is installed on the ground in relatively permanent applications. The tripod has a swivel head assembly and the equipment can be operated by remote control. Provision also is made for operation by a standard hand key when using International Morse Code. The lamp is equipped with sights similar to those of a rifle and can be quickly trained on a given target. Goggles and filters are provided for reception of signals from similar equipment.

Signals of either white or red light can be selected by the operator.

**RELATIONSHIP TO SIMILAR EQUIPMENT:**

**SIGNAL LAMP EQUIPMENT:**  
**AN/PVC-type**  
**SE-11**

**TECHNICAL DESCRIPTION:**

*Type of Signal:* Red or white light flashes.

*Approximate Range:*

Day: 1 1/2 miles.

Night: 5 miles.

*Control:* Self contained trigger or hand key.

*Power Requirements:* 7.5-v dc from 5 Batteries BA-30 in series.

*Major Units:*

1 Signal Lamp M-227	18 1/2" x 6" x 1 3/4"	2.1 lbs.
1 Tripod LG-21	42 extended; 18 collapsed	1.4 lbs.

**TUBES, CRYSTALS, TRANSISTORS:**

**REFERENCE DATA AND LITERATURE:**

TM 11-392.

15 March 1962  
 Cog. Serv.: USN FSN:  
 USA Line Item No:

	USA	USN	USAF	USMC
STATUS OR TYPE CLASS.:		Std		

Manufacturer:

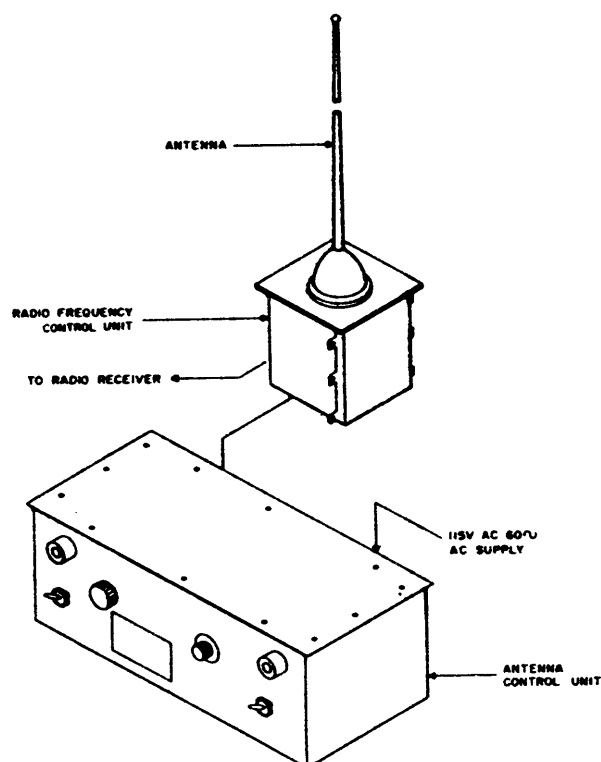

#### FUNCTIONAL DESCRIPTION:

Antenna Group AN/SRA-17B is a compact vlf-lf antenna system used where space for a conventional long wire antenna is not available, or where such antennas would interact with existing antenna installations. The antenna group has three components.

Antenna AT-924A/SR consists of a stainless steel tubular whip and a steel mounting which form part of the top of the radio frequency tuner. Although the whip is fixed in length, the length may be altered electrically for tuning purposes.

Radio Frequency Tuner TN-334A/SRA-17A consists of a single chassis mounted within a housing. The circuits on this chassis tune the antenna and provide a noise source for use as a tuning aid.

Antenna Control Unit C-2536B/SRA-17 is the control center of the antenna group. All operating controls are located on the front panel of the unit. The antenna control unit contains a power supply which energizes the selected antenna tuning circuit, the noise source, and the relays controlling the radio frequency tuner.

**ANTENNA GROUP  
AN/SRA-17B**

**RELATIONSHIP TO SIMILAR EQUIPMENT:**

This group is designed to work with the AN/SRR-11 or RBA; it may be used with any radio receiver tunable over the vlf-lf range.

**TECHNICAL DESCRIPTION:**

*Frequency Range:* 14 to 600 kc, in four bands.

*Band Frequencies:* 14 to 38 kc, 38 to 95 kc, 95 to 235 kc, and 234 to 600 kc.

*Type of Tuning:* saturable reactor.

*Tuner Impedance:* 72 ohms.

*Operating Power Requirement:* 115 v ac, 60 cps, 1 Ø

*Major Units:*

1 AT-2A/SR.

1 TN-334A/SRA-17A.

1 C-2536B/SRA-17.

**TUBES, CRYSTALS, TRANSISTORS:**

**REFERENCE DATA AND LITERATURE:**

NAVSHIPS 94127.

15 March 1962

Cog. Serv.: USA FSN:

USA Line Item No:

USA	USN	USAF	USMC
-----	-----	------	------

---

**STATUS OR TYPE CLASS.:**

---

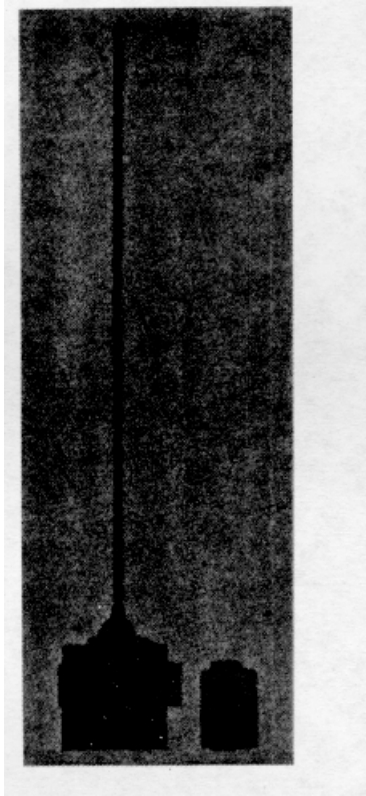
**Manufacturer:** Lyman Electronic Corporation.**FUNCTIONAL DESCRIPTION:**

Antenna Group AN/SRA-28 is used as an antenna for a Loran-A receiver; it is tuned from a control unit located near the receiver. The antenna group consists of three units, two of which are assembled and installed as a single unit.

Antenna AT-1065/U and Radio Frequency Tuner TN-370/SRA-28 are mounted as one unit in the superstructure of the ship. The antenna is a simple whip, and is electrically tuned by a coil and variable capacitor located in the tuner. The capacitor is driven by a motor which is controlled by pushbutton switches at Antenna Control C-3765/SRA-28.

**RELATIONSHIP TO SIMILAR EQUIPMENT:****TECHNICAL DESCRIPTION:**

*Frequency Range:* 1,700 to 2,350 kc.

*Operating Temperature Range:* -28°C. to +65° C.

*Operating Power Requirement:* 115 v, 60 cps, 1 0; 15 w.

**ANTENNA GROUP  
AN/SRA-28**

*Major Units:*

1 ea AT-1065/U, TN-370/SRA-28	73 1/2" x 9 3/8" x 7"	16 lbs.
1 C-3765/SRA-28	8 1/2" x 5 1/4" X 3"	3 lbs.

**TUBES, CRYSTALS, TRANSISTORS:**

**REFERENCE DATA AND LITERATURE:**

NAVSHIPS 94350



**ANTENNA ASSEMBLY**  
**AN/SRA-type**  
**AS-390/SRC**

5 December 1958

Cog. Serv.: USA FSN: 5985-030-0095

USA Line Item No:

	USA	USN	USAF	USMC
<b>STATUS OR TYPE CLASS.:</b>	Std B			

Manufacturer: Bird Electronic Corp

No illustration available

**FUNCTIONAL DESCRIPTION:**

Antenna Assembly AS-390/SRC is a broadband, coaxial stub antenna, used for transmitting or receiving vertically polarized waves at frequencies from 220 to 440 mc.

The antenna is unbalanced to ground and its characteristics are similar to Antenna AT 150/SRC.

**RELATIONSHIP TO SIMILAR EQUIPMENT:****TECHNICAL DESCRIPTION:**

*Frequency Range:* 220 to 440 mc.

*Nominal Input Impedance:* 52 ohms.

*Standing Wave Ratio:* 1.9:1.

*Ambient Temperature Limit:* 177°C. (350°F.)

*Installation:* Mounted on top of a mast or pig stick with main axis vertical.

Major Unit: 1 AS-390/SRC

16" x 23" x 23"

3.625 lbs.

**TUBES, CRYSTALS, TRANSISTORS:****REFERENCE DATA AND LITERATURE:**

NAVSHIPS 91338.

RADIO SET  
AN/SRC-6( )

1 March 1964

Cog. Serv.: USA FSN: 5820-532-3979

USA Line Item No: 644730

	USA	USN	USAF	USMC
STATUS OR TYPE CLASS.:	Std A			

**Manufacturer:** Mackay Radio & Telegraph Co, Inc, Marine Division  
Radio Corporation of America

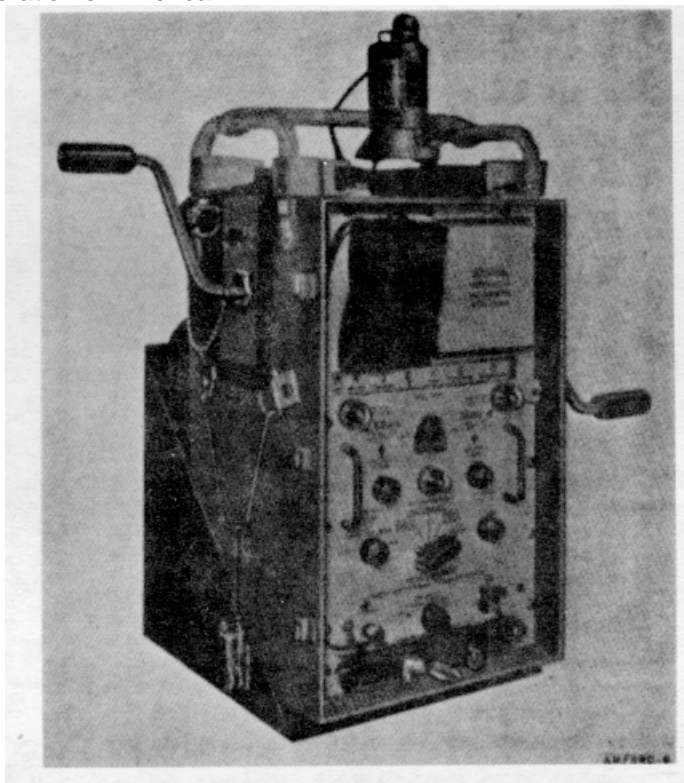
**FUNCTIONAL DESCRIPTION:**

Radio Set AN/SRC-6 (Radiomarine Model ET-8053) (shown above) and Radio Set AN/SRC-6A (Mackay Type 401-A) are portable radiotelegraph transmitters and receivers, powered by a built-in hand driven generator, for emergency use in lifeboats or other survival craft.

This equipment consists of a transmitter and receiver with a built-in hand generator and an antenna system.

Automatic or manual keying is provided to transmit twelve 4-second dashes with 1-second pauses followed by three distress signals on 500 kc, and three distress signals followed by a 30-second dash for direction finding on 8,364 kc.

Two-way communication can be accomplished by manual keying only.

The AN/SRC-6 and AN/SRC-6A are generally interchangeable as to purpose and use.

**RELATIONSHIP TO SIMILAR EQUIPMENT:**

**RADIO SET**  
**AN/SRC-6( )**

**TECHNICAL DESCRIPTION:**

*Frequency Range in mc:*

*Transmitter:* 0.5 to 8.364.

*Receiver:* 0.5 (fixed); 8.25 to 8.75 (AN/SRC-6); 8.266 to 8.745 (AN/SRC-6A).

*Type Modulation:* am.

*Type of Signal:* Modulated keyed telegraphy (rcvr, xmtr); cw (rcvr).

*Power Output:*

AN/SRC-6: 2 w on 0.5 m, 5 w on 8.64 mc.

AN/SRC-6A: 1.7 w (min) on 0.5 mc; 4 w (min) on 8.364 mc.

*Power Requirements:* Built-in hand generator.

*Major Unit:* 1 Watertight case

20 1/2" x 12 1/2" x 14 7/16"

58.5 lbs.

**TUBES, CRYSTALS, TRANSISTORS:**

**REFERENCE DATA AND LITERATURE:**

Commercial Instruction Book NAVSHIPS 92207.

RADIO SET  
AN/SRC-7

1 March 1964

Cog. Serv.: USA FSN: 5820-567-2386

USA Line Item No: 644740

	USA	USN	USAF	USMC
STATUS OR TYPE CLASS.:	Std A			

Manufacturer: Radio Corporation of America

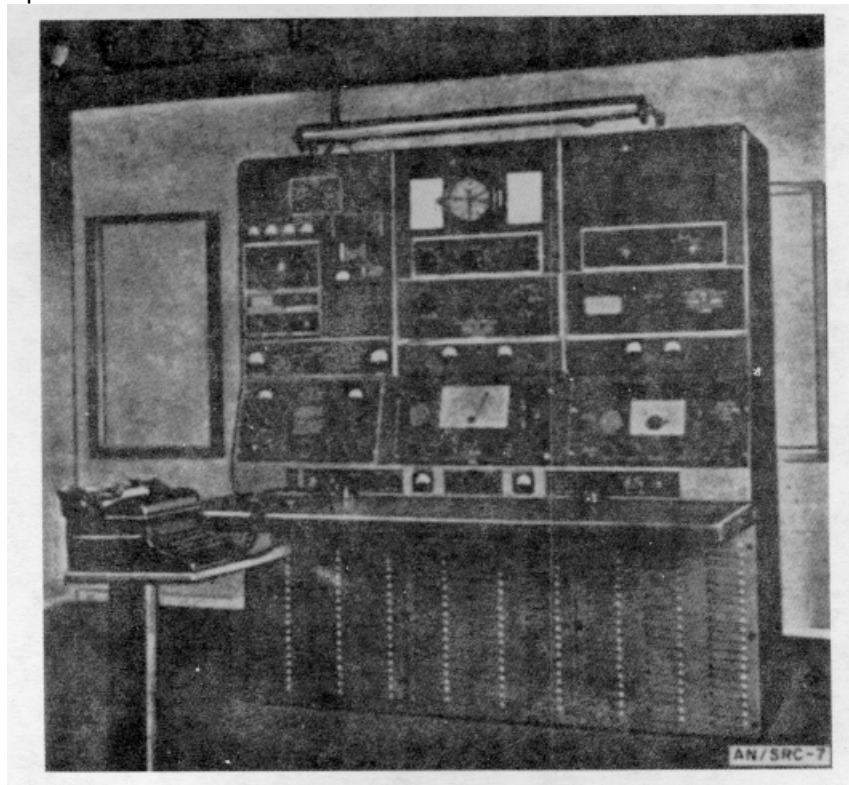
**FUNCTIONAL DESCRIPTION:**

Radio Set AN/SRC-7 (Radiomarine Model 5U) is a self-contained radiotelegraph communication set providing medium- and high-frequency emergency communication facilities.

This equipment consists of two medium-frequency transmitters (one main and one emergency), an hf transmitter, and hf receiver, one receiver that can receive in both the low- and medium-frequency bands, an auto alarm, an auto alarm keyer, control panels, power components, antennas, and accessories.

The main medium-frequency transmitter and the hf transmitter are crystal-controlled. The emergency transmitter is master-oscillator controlled. The emergency transmitter is operated from a 12-volt storage battery (through a battery charger from the ship's line under normal conditions). The low- and medium-frequency receiver operates from a 12-volt storage battery and a 90-volt B battery, under emergency conditions; normally it operates from the ship's line as does the rest of the equipment.

This equipment can be operated on ships that have either ac or dc power or a combination of the two.

**RELATIONSHIP TO SIMILAR EQUIPMENT:**

**RADIO SET  
AN/SRC-7**

**TECHNICAL DESCRIPTION:**

*Frequency Range in Mc:* 0.015 to 0.65 (low- and medium-freq rcvr); 0.085 to 0.55, 1.9 to 25 (hf rcvr); 0.35 to 0.515 (main and emer xmtr); 2 to 24 (hf xmtr).

*Type Modulation:* am.

*Type of Signal:* cw, mew.

*Power Output:* 40 w (mcw, emer xmtr); 200 w (cw), 250 w (mcw) (main medium-freq xmtr); 300 w (cw, hf xmtr).

*Power Requirement:* 17.4 amp 115-v 60-cy 1-phase ac (Code A); 11.3 amp, 115-v dc (Code A); 22 amp, 115-v 60-cy 1-phase ac (Code B); 32 amp, 115-v dc (Code C); 22 amp, 230-v dc (Code D). For operation from 220- or 440-v ac, a step-down transformer is used; dc is supplied by a rotary converter.

*Major Units:*

- 1 Dynamotor power.
- 1 MD-220/SRC-7.
- 1 ea PP-1068, 1069, 1070, 1071/SRC-7.
- 1 ea R-597, 598, 599/SRC-7.
- 1 ea T446, 447, 448/SCR-7.

**TUBES, CRYSTALS, TRANSISTORS:**

**REFERENCE DATA AND LITERATURE:**

Commercial Instruction Book.

**RADIO SET  
AN/SRC-8( )**

1 March 1964

**Cog. Serv.:** USA FSN: 5820-567-2387 (AN/SRC-8), 5820-567-2388 (AN/SRC-8X), 5820-567-2361 (AN/SRC-8XX),  
5820-503-2580 (AN/SRC-8Y)

**USA Line Item No:** 644750

	USA	USN	USAF	USMC
<b>STATUS OR TYPE CLASS.:</b>	Std A		Std	

**Manufacturer:** Munston Mfg & Service, Inc.

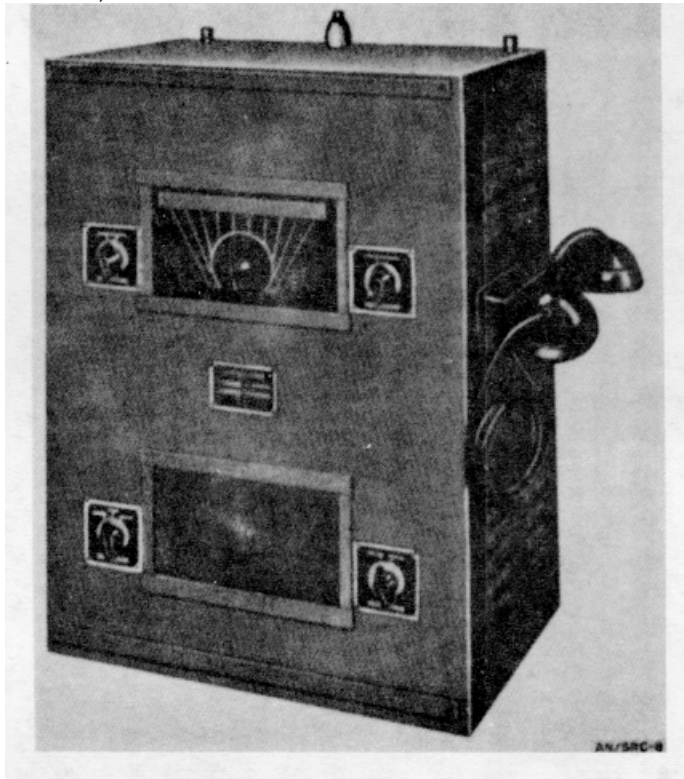

**FUNCTIONAL DESCRIPTION:**

Radio Set AN/SRC-8( ) (Ray Jefferson, Inc. Model 914 Radio Telephone) provides medium-frequency, two-way, ship-to-shore and ship-to-ship radio telephone service for ships in coastwise waters.

This equipment consists of a transmitter, a receiver, in antenna, accessories, and power components.

The AN/SRC-8 and the AN/SRC-8X operate from a 115-volt dc and ac power source, respectively; the AN/SRC-8XX and AN/SRC-8Y operate respectively from 12-volt and 32-volt batteries.

**RELATIONSHIP TO SIMILAR EQUIPMENT:**

**TECHNICAL DESCRIPTION:**

*Frequency Range in Mc:* 2 to 3.

*Type Modulation:* am.

*Type of Signal:* Voice.

*Power Output:* 50 w.

**RADIO SET**  
**AN/SRC-8( )**

*Power Requirements:*

AN/SRC-8: 115-v dc.  
 AN/SRC-8X: 115-v 60-cy ac.  
 AN/SR08XX: 12-v dc.  
 AN/SRC-8Y: 32-v dc.

*Major Unit:*

For AN/SRC-8:			
1 ea AT-609/SRC-8, PU-283/SRC-8, RT-306/SRC	25 1/4" x 19 7/8" x 13"		72 lbs.
For AN/SRC-8X:			
1 ea AT-609/SRC-8, PP-1055/SRC-8X, RT-306/SRC.	25 1/4" x 19 7/8" x 13"		72 lbs.
For AN/SRC-8XX:			
1 ea AT-609/SRC-8, DY-126/SRC-8XX.			
or			
1 ea DY-127/SRC-8XX, RT327/SRC	25 1/4" x 19 7/8" x 13"		72 lbs.
For AN/SRC-8Y:			
1 ea AT-609/SRC-8, DY-122/SRC-8Y.			
or			
1 ea DY-123/SRC-8Y, RT-327/SRC	25 1/4" x 19 7/8" x 13"		72 lbs.

**TUBES, CRYSTALS, TRANSISTORS:**

**REFERENCE DATA AND LITERATURE:**

TM 11-253.

1 March 1964

Cog. Serv.: USA FSN:

USA Line Item No:

USA	USN	USAF	USMC
-----	-----	------	------

---

**STATUS OR TYPE CLASS.:**

---

Manufacturer: CBSL(82692).

No illustration available

**FUNCTIONAL DESCRIPTION:**

Radio Set AN/SRC-9 is a compact, rugged, radiotelegraph transmitter-receiver for communication between survival craft and rescue vessels. The equipment design assures effective use of the transmitter by personnel not trained in communications. A built-in distress signal keyer enables automatic transmission of code sequences.

**RELATIONSHIP TO SIMILAR EQUIPMENT:****TECHNICAL DESCRIPTION:***Transmitter:**Output Frequencies:* 500 kc and 8364 kc (crystal controlled).*Power Output:*

500M kc: Not less than 30w into 10 ohms and 100 mmf.

8384 kc: Not less than 40 w into 40 ohms.

*Type of Emission:* A-2 (modulated keyed telegraphy).*Modulation Frequency:* 600 cps (approximate).*Maximum deviation from nominal output frequency:*

500 kc 0.02 percent.

8364 kc 0.02 percent.

*Receiver:*

Frequency range: 492 kc to 508 kc (fixed tuned).

8,100 kc to 8,900 kc (tunable).

Sensitivity: 500 kc less than 25  $\mu$ v.8,364 kc less than 100  $\mu$ v.*Selectivity:* Within 6 db between 492 kc and 508 kc.*Audio C:* Within 6 db between 400 cps and 1,400 cps.*Output Impedance:* 1,500 ohms at 1,000 cps.*Power Source:* 12 v dc storage battery.*Signal Keyer:*

Keying cy (2 minutes):

500 kc 12A/A dashes, 3 SOS signals.

8364 kc: 3 SOS signals, 30 sec direction finder dash.

Keying Motor: Constant speed 12 v dc, 2 RPM.

*Operating Power Requirement:*

Low Voltage Dynamotor:

Input 3.4 amp at 12 v dc.

Output 85 ma at 250 v dc.



**RADIO SET  
AN/SRC-9**

*High Voltage Motor-Alternator:*

Input 25 amp at 12 v dc.

Output 300 ma at 440 vac at 600 cps.

*Major Unit:*

1 AN/SRC-9

22" x 21" x 15"

92 lbs.

**TUBES, CRYSTALS, TRANSISTORS:**

**REFERENCE DATA AND LITERATURE:**

NAVSHIPS 92364

1 March 1964

Cog. Serv.: USA FSN:

USA Line Item No:

USA	USN	USAF	USMC
-----	-----	------	------

**STATUS OR TYPE CLASS.:**

Manufacturer: COL (13499)

**No illustration available****FUNCTIONAL DESCRIPTION:**

Radio Set AN/SR-20 is a surface-to-air or surface-to-surface shipboard or fixed station uhf communication equipment that provides simplex amplitude modulation. Provisions are included for complete control, including preset channel selection, from as many as four remote control points. Circuits are provided so that two sets may be interconnected for two way automatic retransmission operation. Provisions are included for operation with special purpose equipment requiring broadband audio.

During transmission, the 15-20 watt output of the exciter, Radio Set AN/URC-9, is amplified to 100 w min carrier level. In case of failure of the power amplifier, the 15-20 w output of the exciter can be used for emergency communications.

**RELATIONSHIP TO SIMILAR EQUIPMENT:****TECHNICAL DESCRIPTION:**

*Operating Power Requirements:* 115/230 v, 60 cy, 500 w at 90 percent power factor for receiving and 1440 w at 90 percent power factor for transmitting at full modulation.

*Temperature:* Operating 0°C. to 50°C. (limited by Radio Set Control C3866/SRC) Radio Set AN/URC-9 Characteristics.

Frequency Range: 225.0 to 399.9 mc.

Number of Channels: 1,750 with 100 kc spacing.

Frequency Stability: Within  $\pm 12$  kc of nom channel frequency over the ambient temperature range of  $-55^{\circ}\text{C}$ . to  $65^{\circ}\text{C}$ .

Frequency Control: Completely crystal controlled, using 35 crystals.

Channel Selection Time: 8 sec max.

Preset Channels: 19 plus 1 manually tuned channel.

Power Requirements: 115/230 v, 50-60 cy, 250 w at 92 percent power factor for receiving and 400 w at 95 percent power factor transmitting at full modulation.

*Transmitting Characteristics:*

Power Output: More than 15 w into 50 ohm nom resistive load.

Modulation: am.

Fidelity: Within  $\pm 3$  db from 300 to 3,500 cps, 1,000 cps reference.

Audio Distortion: Less than 10 percent.

Sidetone: 175 mw from receiver audio output into 600 ohm load.

Broadband Capability: Auxiliary input to modulator permits modulation and carrier with frequencies from 300 to 25,000 cps.

Duty Cycle: Continuous transmission with 85 percent modulation at  $65^{\circ}\text{C}$ . ambient temperature.

Retransmission: Audio and control circuits provided.

## RADIO SET AN/SRC-20

### *Receiving Characteristics:*

Sensitivity: 6  $\mu$ v or less (in series with 50 ohms) for a 10 db signal-plus-noise to noise ratio.

Selectivity: 6 db 7 kc, 60 db 145 kc.

IF Rejection: More than 100 db attenuation.

Image Responses: More than 60 db attenuation.

Spurious Responses: Frequencies 100 kc or more from carrier are attenuated over 60 db.

AVC Characteristics: Audio output is held within  $\pm 3.5$  db with signal levels from 6  $\mu$ v to 1 v, compared to the output with a 100  $\mu$ v reference signal.

Squelch: A squelch relay is activated by either a carrier level circuit or a circuit that compares the relative ratio of audio and noise voltage from the detected carrier. The squelch relay is actuated when: (a) the signal-plus-noise to noise ratio exceeds 2 db; or (b) the carrier level exceeds 3  $\mu$ v, both levels being adjustable.

Audio Frequency Response: Within  $\pm 3$  db from 300 to 3,500 cps.

Audio Distortion: 10 percent max.

Audio Outputs:

(a) Headset and Remote Output: 2 w, 600 ohms.

(b) Retransmission Output: 10 mw, 600 ohms (receiver audio).

(c) Broadband Output: 1 v, 600 ohms, 300-25,000 cps.

AVC Time Constant: Approximately 0.15 sec.

### *Radio Frequency Amplifier AM-1565/URC Characteristics:*

Frequency Range: 225.0 to 399.9 mc.

Channel Spacing: Continuously tuned.

Frequency Stability: Determined by exciter stability.

Channel Selection Time: Less than 10 sec.

Power Requirements: 115/230 v, 50-60 cy, 250 w at 90 percent power factor for receiving and 1,000 w at 90 percent power factor for transmitting at full modulation.

RF Power Output: 100 w min carrier.

Output Impedance: 50 ohms nom.

RF Excitation Required: Less than 15 w.

Input Impedance: 50 ohms nom.

Envelope Distortion: 5 percent max at 95 percent modulation.

Spurious Radiation: 60 db below carrier level.

Noise modulation: 40 db below 95 percent modulation when excited by a signal having a noise level 45 db below 95 percent modulation.

### *Radio Set Control C-3866/SRC Characteristics:*

Channels: 19.

Channel Selection Time: Approx 1 sec.

Power Requirements: 115/230 v, 60 cy, 40 w at 85 percent power factor.

12 v dc Power Supply: Supplies a nom 12 v dc at 660 ma continuous, 1.2 amp for 1 min to the remote microphones, keying relays, and carrier-on indicator lamps.

*Microphone Circuit:* Matches 82 ohm microphone input circuit of AN/URC-9 to the 600 ohm output of the radiotelephone unit.

*Audio Isolation Circuit:* Isolates the AN/URC-9 receive audio output, which has one side grounded, from the radio telephone unit ungrounded audio circuit.

**RADIO SET  
AN/SRC-20***Major Units:*

1	AN/URC-9	12 1/4" x 19" x 19 1/2"	157 lbs.
1	AM-1565/URC	15 3/4" x 19" x 21 3/4"	215 lbs.
1	C-3866/SRC	10 1/2" x 19" x 17Yn"	55 lbs.
1	MT-229/UR	52 17/32" x 22 1/16" x 23 7/32"	84 lbs.

**TUBES, CRYSTALS, TRANSISTORS:****REFERENCE DATA AND LITERATURE:**

Collins Radio Co. Commercial Brochure CDS-385.

1 March 1964

Cog. Serv.: USA FSN:

USA Line Item No:

USA	USN	USAF	USMC
-----	-----	------	------

**STATUS OR TYPE CLASS.:**

Manufacturer: COL (13499)

No illustration available

**FUNCTIONAL DESCRIPTION:**

Radio Set AN/SRC-21 is a surface-to-surface or surface-to-air shipboard or fixed station uhf communication equipment which provides simplex amplitude modulation. Provisions are included for complete control, including preset channel selection, from as many as four remote control points. Circuits are provided so that two sets may be interconnected for two way automatic retransmission operation. Provisions are included for operation with special purpose equipment requiring broadband audio.

**RELATIONSHIP TO SIMILAR EQUIPMENT:**

Similar to Radio Set AN/SRC-20 except contains no linear power amplifier.

**TECHNICAL DESCRIPTION:**

*Operating Power Requirements:* 115/230 v, 60 cy, 290 w at 92 percent pwr factor for receiving and 440 w at 95 percent pwr factor for transmitting at full modulation.

*Temperature:* Operating 0°C. to 50°C. (limited by Radio Set Control C-3866/SRC).

*Radio Set AN/URC-9 Characteristics:*

Frequency Range: 225.0 to 399.9 mc.

Number of Channels: 1,750 with 100 kc spacing.

Frequency Stability: Within  $\pm 12$  kc of normal channel frequency, over ambient temperature range of -55° C. to 65° C.

Frequency Control: Completely crystal controlled, using 35 crystals.

Channel Selection Time: 8 sec max.

Preset Channels: 19 plus 1 manually tuned channel.

Operating Power Requirements: 115/230 v, 50-60 cy, 250 w at 92 percent pwr factor for receiving and 400 w at 95 percent pwr factor transmitting at full modulation.

*Transmitter Characteristics:*

Power Output: More than 15 w into 50 ohm nominal resistive load.

Modulation: am.

Fidelity: Within  $\pm 3$  db from 300-3,500 cps, 1,000 cps reference.

Audio Distortion: less than 10 percent.

Sidetone: 175 mw from receiver audio output into 600 ohm load.

Broadband Capability: Auxiliary input to modulator permits modulation of carrier with frequencies from 300 to 25,000 cps.

*Duty Cycle:* Continuous transmission with 85 percent modulation at 65° C. ambient.

*Retransmission:* Audio and Control circuits provided.

*Receiver Characteristics:*

Sensitivity: 6  $\mu$ v or less (in series with 50 ohms) for a 10-db signal-plus-noise to noise ratio

Selectivity: 6 db 76 kc; 60 db 145 kc.

**RADIO SET  
AN/SRC-21**

IF Rejection: More than 100 db attenuation.

Image Responses: More than 60 db attenuation.

Spurious Responses: Frequencies 100 kc or more from carrier are attenuated over 60 db.

AVC Characteristics: Audio output is held within  $\pm 3.5$  db with signal levels from 6  $\mu$ v to 1 v, compared to the output with a 100  $\mu$ v reference signal.

Squelch: A squelch relay is activated by either a carrier level circuit or a circuit that compares the relative ratio of audio and noise voltage from the detected carrier. The squelch relay is activated when: (a) the signal-plus-noise to noise ratio exceeds 2 db; or (b) the carrier level exceeds 3  $\mu$ v, both levels being adjustable.

Audio Frequency Response: Within  $\pm 3$  db from 300 to 3,500 cps.

Audio Distortion: 10 percent max.

Audio Outputs:

(a) Headset and remote output: 2 w, 600 ohms.

(b) Retransmission Output: 10 mw, 600 ohms (receiver audio).

(c) Broadband Output: 1 v, 600 ohms, 300-2,500 cps.

AVC Time Constant: Approx 0.15 sec.

*Radio Set Control C-3866/SRC Characteristics:*

Channels: 19.

Channel Selection Time: approx 1 sec.

Power Requirements: 115/230 v, 60 cy, 40 w at 85 percent pf 12-v dc Power Supply: Supplies a nominal 12 v dc at 660 ma continuous, 1.2 amp for 1 min to the remote microphones, keying relays, and carrier-on indicator lamps.

Microphone Circuit: Matches 82 ohm microphone input circuit of AN/URC-9 to the 600 ohm output of the radiotelephone unit.

Audio Isolation Circuit: Isolates the AN/URC-9 receiver audio output, which has one side grounded, from the radiotelephone unit ungrounded audio circuit.

*Major Unit:*

1	AN/URC-9	12 1/4" x 19" x 19 1/2"	157 lbs.
1	C-3877/SRC	10 1/2" x 19" x 17 5/32"	55 lbs.
1	MT-2300/UR	35 1/32" x 22 1/16" x 26 5/16"	72 lbs.

**TUBES, CRYSTALS, TRANSISTORS:**

**REFERENCE DATA AND LITERATURE:**

Collins Radio Co. Commercial Brochure CDS-385.

**ELECTRICAL FREQUENCY SYNTHESIZER**  
**AN/SRC-type**  
**O-464/SRC, O-792/SRC**

1 March 1964

Cog. Serv.: USA FSN: 5820-448-0303 (Model O-464/SRC)

USA Line Item No: 5820-674-5834 (Model O-792/SRC)

USA    USN    USAF    USMC

**STATUS OR TYPE CLASS.:**

Manufacturer: CCWR (93279)

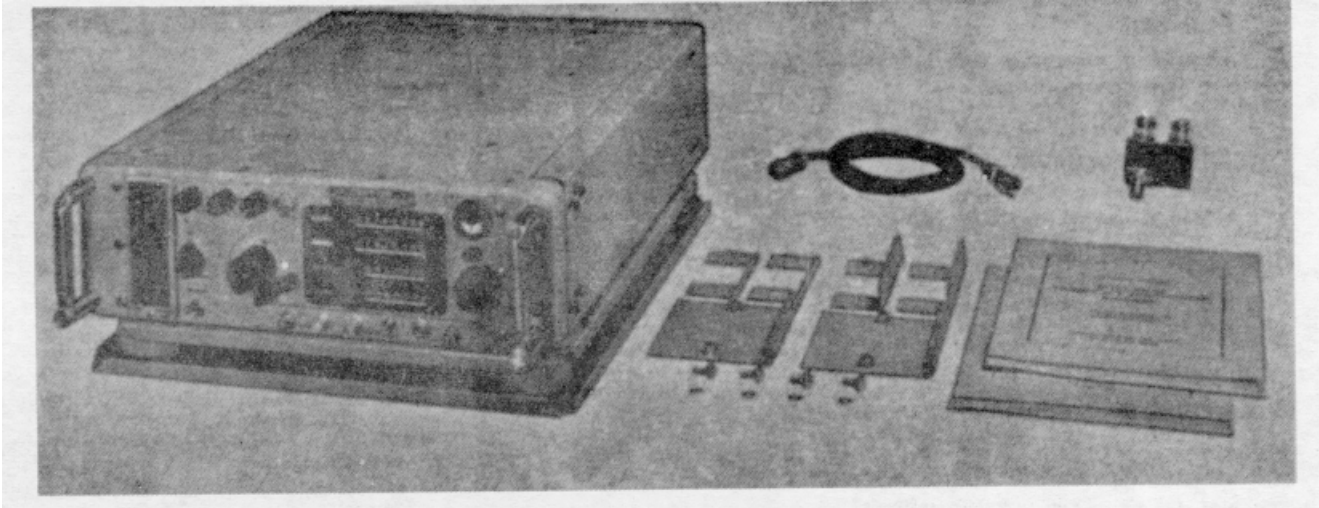

**FUNCTIONAL DESCRIPTION:**

Electrical Frequency Synthesizers O-464/SRC and O-792/SRC, are frequency generators which, provide more than 64, 000 frequencies in the range of 2 to 34 mc, covered in four bands: 2 to 4.25 mc 4 to 8.5 me, 8 to 17 me, and 16 to 34 me. Auxiliary outputs of 1 mc and 100 kc are also provided. The stability of all output frequencies is 1 part in  $10^8$  per day. The synthesizer may be used as a frequency standard, transmitter exciter, and receiver local oscillator.

**RELATIONSHIP TO SIMILAR EQUIPMENT:**

Electrical Frequency Synthesizer Models O-464/SRC and O-792/SRC are basically the same except that the latter operates on 400 cycles. Preceding models are O-464(XN-1)/SRC and O-464 (XN-2)/SRC.

**TECHNICAL DESCRIPTION:**

*Frequency Range:* 2-34 mc.

*Frequency Stability:* 1 part in  $10^8$  per day.

*Tuning Bands:* four.

Band 1: 2 to 4.25 me in 125 cy steps.

Band 2: 4 to 8.5 me in 250 cy steps.

Band 3: 8 to 17 me in 500 cy steps.

Band 4: 16 to 34 mc in 1,000 cy steps.

*Auxiliary Output Frequencies:* 1 mc and 100 kc.

**ELECTRICAL FREQUENCY SYNTHESIZER**  
**AN/SRC-type**  
**O-464/SRC, O-792/SRC**

*Output Levels:* Adjustable within 1 to 2.5 v at 2-34 mc; 1 v at 1 mc and 100 kc.

*Output Impedances:* 50 ohms at 2 to 34 mc and 1 mc; 500 ohms at 100 kc.

*Readability Error:* Zero.

*Readability Error:* Zero.

*Internal Reference:* 1 mc crystal-controlled oscillator using type CR-28/U AT cut crystal enclosed in 75°C. temperature-regulated oven.

*External Auxiliary Reference Source:* 1 mc or 100 kc at 1 v.

*Meters:* VTVM monitoring meter.

*Input Power:* 105/125 v ac, 50/60 cps or 400 cps, single phase, 1.7 amp at 115 vac.

*Dissipation:* 130 w.

The synthesizer should be located to permit connections to the equipment(s) being supplied with the output frequencies of the synthesizer. The location should provide adequate clearance for removal of the synthesizer from its case, tilting it on the tilt-slide assembly for servicing and access to the connectors at the rear of the case. The synthesizer is designed for bench or relay-rack mounting.

*Mounting Dimensions:*

Bench Installation 7 1/4" x 17 1/4" x 21 1/2".

Relay-Rack Installation: 5 1/4" x 18 1/4" x 21 1/2".

*Number of Operators Required:* One.

*Major Units:*

O-464/SRC or O-792/SRC (without mounting) 10.4 cu ft 15" x 30" x 40" 175 lbs.

O-464/SRC or O792/SRC (with mounting MT-2431/U) 12.5 cu ft 18" x 30" x 40" 190 lbs.

**TUBES, CRYSTALS, TRANSISTORS:**

**REFERENCE DATA AND LITERATURE:**

NAVSHIPS 93797.



RADIO SET  
AN/SRC-type  
SCR-281( )

1 March 1964

Cog. Serv.: USA FSN: 5820-186-9257

USA Line Item No: 651700

	USA	USN	USAF	USMC
STATUS OR TYPE CLASS.:	L/Std			

Manufacturer:

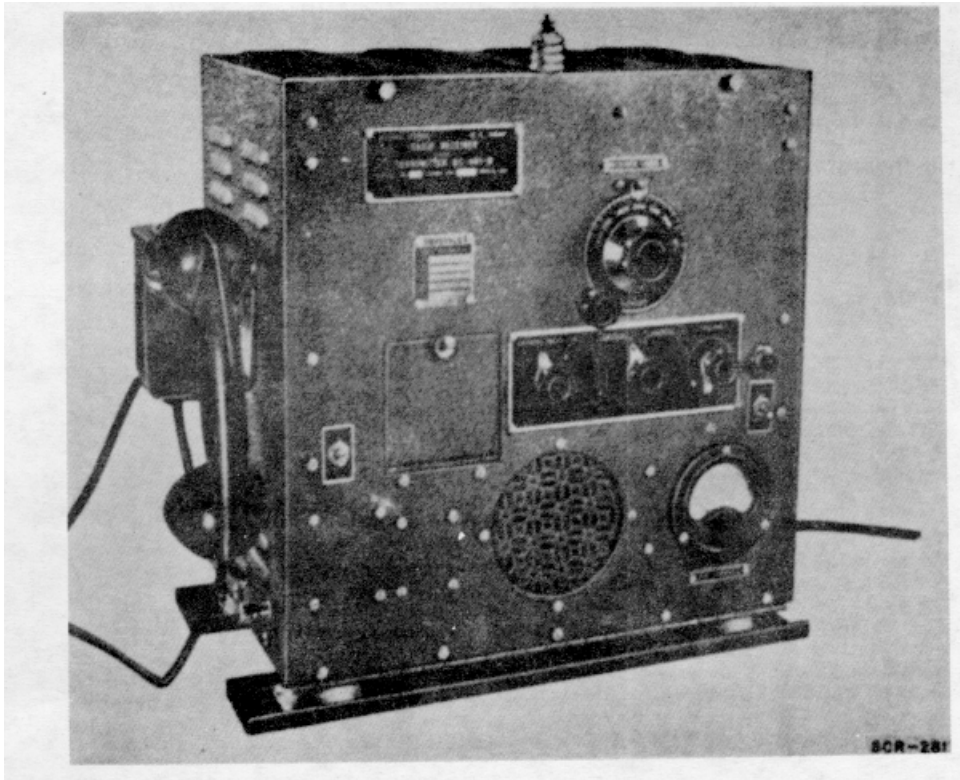

#### FUNCTIONAL DESCRIPTION:

Radio Set SCR-281 ( ) is a medium-power, crystal-controlled am(voice) transmitting and receiving equipment used for ship-to-ship, ship-to-shore, and shore station communication in coastwise and harbor-control applications.

This equipment consists of a radio transmitter and a radio receiver assembled within a single metal cabinet that may be floor-, deck-, shelf-, or platform-mounted. It has a shock mounting and a handset and the receiver section includes a loudspeaker.

It can be operated on one of four channels, preselected by means of appropriate plug-in crystals and includes provision for control of transmitter-receiver change-over by means of the press-to-talk switch of the handset.

It can use a conventional long-wire antenna or equivalent system but it can be operated with a whip-type array 35 feet in length.

#### RELATIONSHIP TO SIMILAR EQUIPMENT:

**RADIO SET**  
**AN/SRC-type**  
**SCR-281( )**

**TECHNICAL DESCRIPTION:**

*Frequency Range in Mc:* 1.7 to 2.75.

*Type Modulation:* am.

*Type of Signal:* Voice only.

*Power Output.* 25 w.

*Power Requirements:*

Transmitter: 230 w, 115-v 60-cy 1-phase ac.

Receiver: 107 w, 115-v 60-cy 1-phase ac.

Major Unit: BC-441      16" x 10" x 16" 102 lbs.

**TUBES, CRYSTALS, TRANSISTORS:**

**REFERENCE DATA AND LITERATURE:**

TM 11-244.

(USA) 71-3402.

RADIO RECEIVER  
AN/SRR-type  
R-96( )/SR

1 March 1964

Cog. Serv.: USA FSN: 5820-221-0177

USA Line Item No: 635620

	USA	USN	USAF	USMC
STATUS OR TYPE CLASS.:	Std C			

Manufacturer: The Hallicrafters Co.

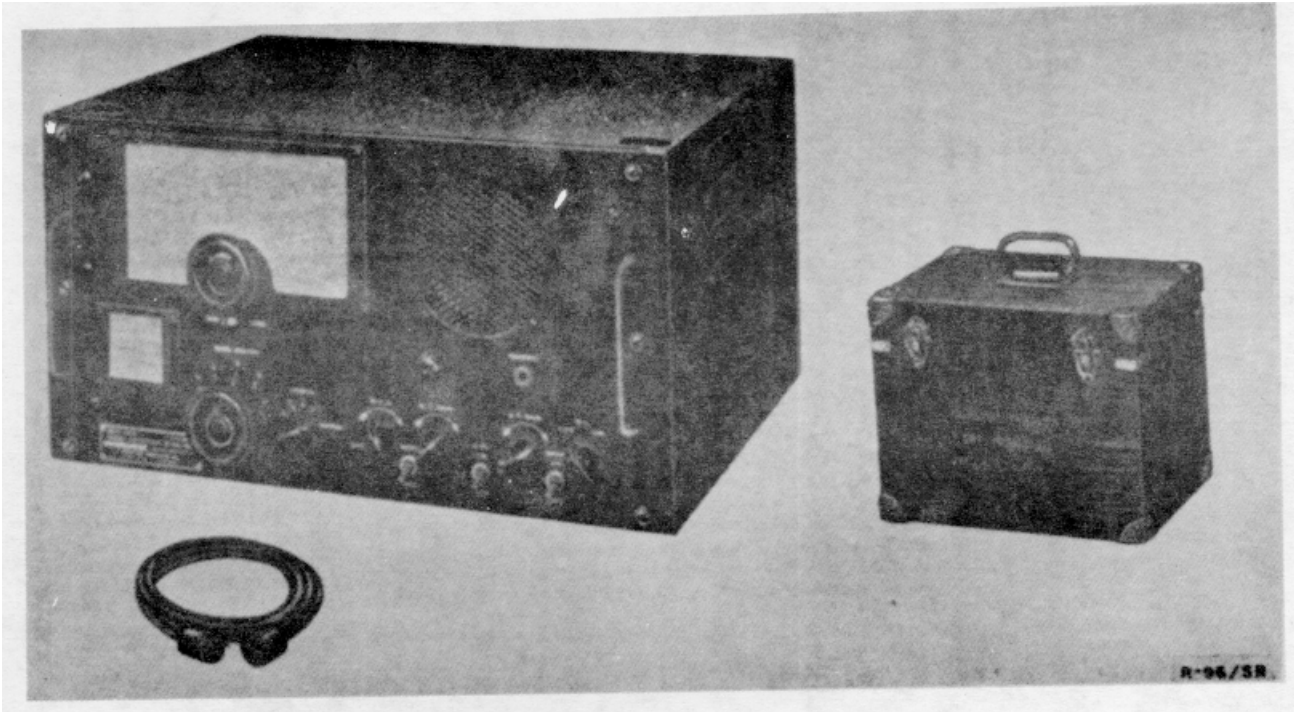

#### FUNCTIONAL DESCRIPTION:

Radio Receiver R-96( )/SR is a five-channel, am (voice, cw, icw, and mew) receiving equipment used in the low-, medium-, and high-frequency bands in radio operation aboard ship. It may be installed on harbor patrol or seagoing craft.

This equipment consists of a crystal-controlled receiver designed to operate in conjunction with Radio Transmitter T-83/SR, to which it may be connected by cables. Change-over relays in the transmitter control sending and receiving and are operated by means of the press-to-talk switch in the handset.

This receiver requires a conventional ship's antenna or other suitable array.

#### RELATIONSHIP TO SIMILAR EQUIPMENT:

#### TECHNICAL DESCRIPTION:

*Frequency Range in Mc:* 0.135 to 12.12 in 5 overlapping bands.

*Type Modulation:* am.

*Type of Signal:* Voice, cw, icw, mcw.

*Power Requirements:* 0.4 amp, 115-v dc or 115-v 50/60-cy ac.

*Major Units:* 1 R-96( )/SR

10" x 20 7/8" x 17 1/2"

87.5 lbs.

RADIO RECEIVER  
AN/SRR-type  
R-96( )/SR

TUBES, CRYSTALS, TRANSISTORS:

REFERENCE DATA AND LITERATURE:

TM 11-878A.  
(USA) 69-3.

RADIO RECEIVER  
AN/SRR-type  
R-212/SR

1 March 1964

Cog. Serv.: USA FSN: 5820-164-7185

USA Line Item No: 635840

	USA	USN	USAF	USMC
STATUS OR TYPE CLASS.:	Std A			

Manufacturer:

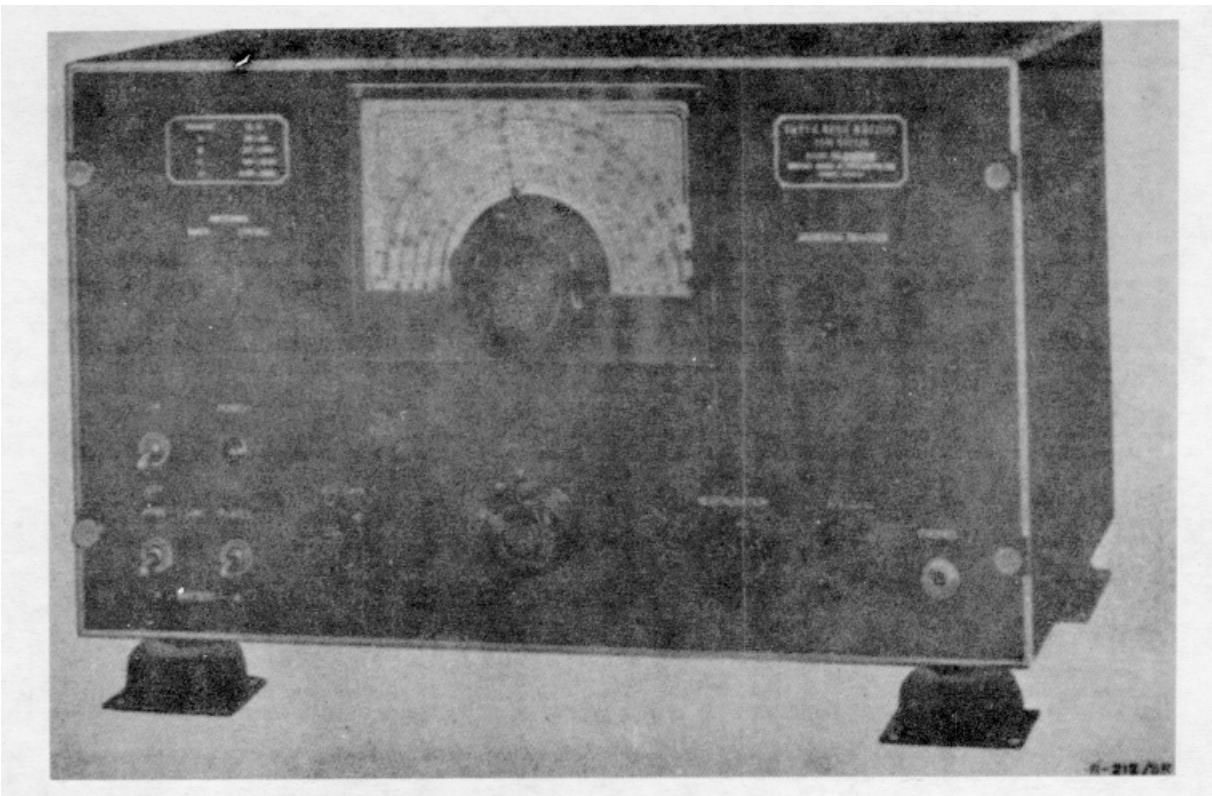

#### FUNCTIONAL DESCRIPTION:

Radio Receiver R-212/SR is a tuned-radio-frequency, am (cw, icw, and mew) radiotelegraph receiver equipment used in shipborne and fixed station applications.

This equipment consists of a commercial (Federal 128 AY) receiver having a regenerative detector. It can be operated with a single wire antenna system.

It operates on ac or dc or from storage or dry batteries and has a power-selection switch by means of which the power source can be selected.

#### RELATIONSHIP TO SIMILAR EQUIPMENT:

#### TECHNICAL DESCRIPTION:

*Frequency Range in Mc:* 0.015 to 0.650 in 4 overlapping bands.

*Type Modulation:* am.

*Type of Signal:* Cw and mew.

**RADIO RECEIVER**  
**AN/SRR-type**  
**R-212/SR**

*Power Requirements:*

ac: 36 w; 115 v, 60 cy;

dc Line Plus A Battery: 0.17 amp at 115 v from line, 1.9 amp at 6.3 v from battery; or

Batteries: 1.9 amp at 6.3 v from A battery and 7 to 12 ma at 90 v from B battery.

*Major Units:* Radio Receiver R-212/SR 43 lbs.

(Equipment consists of only one major component.)

**TUBES, CRYSTALS, TRANSISTORS:**

**REFERENCE DATA AND LITERATURE:**

TM 11-868.

**RADIO TRANSMITTING SET  
AN/SRT-3( )**

1 March 1964

Cog. Serv.: USA FSN: 5820-189-7040

USA Line Item No: 657980

	USA	USN	USAF	USMC
<b>STATUS OR TYPE CLASS.:</b>	Std C			

**Manufacturer:** Radiomarine Corp. of America.

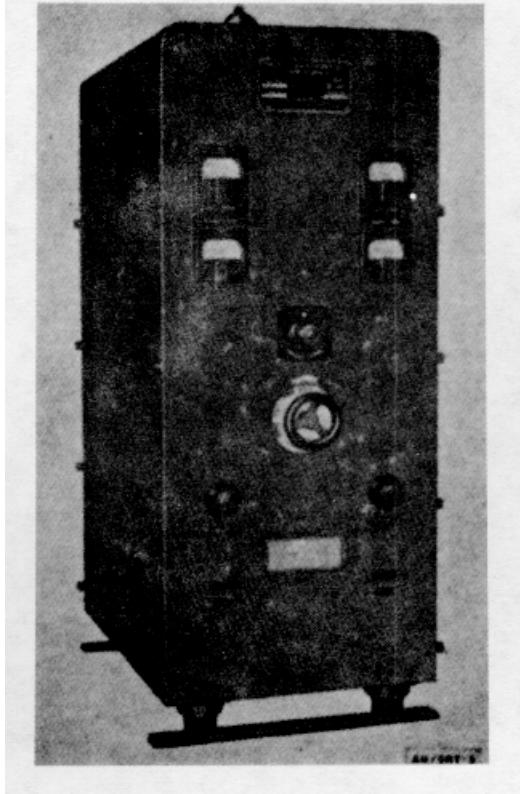

**FUNCTIONAL DESCRIPTION:**

Radio Transmitting Set AN/SRT-3( ) is a medium-power, medium-range, crystal-controlled am (cw and mcw) transmitting equipment for ship-to-ship and ship-to-shore communication in the mf band.

This equipment consists of a floor-type transmitting assembly fitted with shock-mountings and includes a motor generator, plus associated components.

It can be used in emergencies by adding an emergency panel and a small dynamotor.

The set operates in eight preset frequency channels and uses the normal ship's antenna system.

This equipment has been replaced by Radio Set AN/SRC7.

**RELATIONSHIP TO SIMILAR EQUIPMENT:**

**TECHNICAL DESCRIPTION:**

*Frequency Range in Mc:* 0.35 to 0.515.

*Type Modulation:* am.

*Typo of Signal:* Cw and mew.

**RADIO TRANSMITTING SET  
AN/SRT-3()**

*Power Output:* 300 w, mcw; 200 w, cw.

*Power Requirements:* 1,300 w, 150/230-v dc; or 4.5 am, 220/440-v 60-cy 3-phase ac.

*Major Units:*

1	Motor Generator	14 1/8" x 27 3/4" x 9 3/4"	225 lbs.
1	Transmitter	44 3/4" x 17 3/8" x 28 3/4"	200 lbs.

**TUBES, CRYSTALS, TRANSISTORS:**

**REFERENCE DATA AND LITERATURE:**

TM 11-860.

Wilcox 25-2220.



RADIO TRANSMITTING SET  
AN/SRT-4( )

1 March 1964

Cog. Serv.: USA FSN: 5820-189-7032

USA Line Item No: 657981

	USA	USN	USAF	USMC
STATUS OR TYPE CLASS.:	Std B			

Manufacturer: Radiomarine Corp. of America.

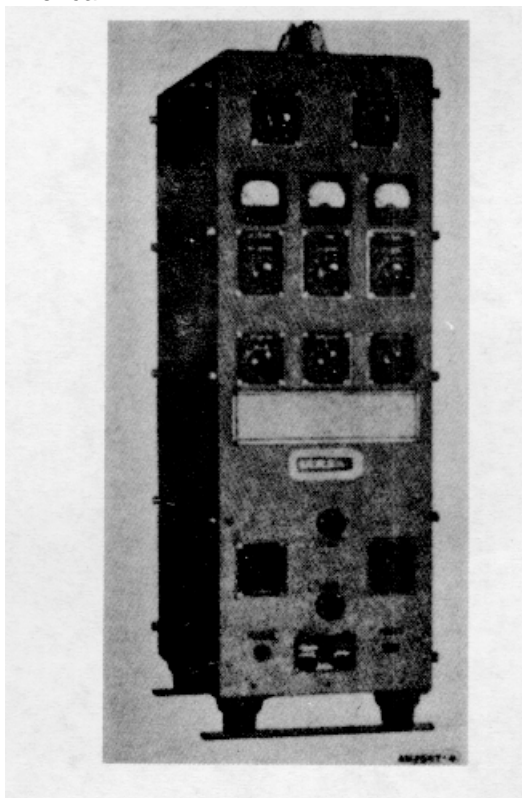
**FUNCTIONAL DESCRIPTION:**

Radio Transmitting Set AN/SRT-4( ) is a low-power, medium-range, am (cw and mcw) transmitting equipment designed for use aboard ship in ship-to-ship or ship-to-shore communication in the mf and hf bands.

This equipment consists of a single, shock-mounted, floor-type cabinet containing the operating components and control apparatus. It includes a motor generator and motor starter, control panel, crystal units, and related items. It operates on two preset frequencies and uses the ship's antenna array.

**RELATIONSHIP TO SIMILAR EQUIPMENT:****TECHNICAL DESCRIPTION:**

*Frequency Range in mc:* 2.00 to 22.14.

*Type Modulation:* am.

*Type of Signal:* Cw, mcw.

*Power Output:* 200 w below 17 mc, 150 w above 17 mc.

*Power Requirements:* 1,300 w, 115-v dc.

**RADIO TRANSMITTING SET  
AN/SRT-4( )**

*Major Units:*

1	F-198/SRT-3A	9 3/4" x 3" x 6"	6.75 lbs.
1	C-1192/SRT-4A	12 1/4" x 7 3/8" x 10 1/2"	14.5.
1	PU-255/SRT-3A	14 1/8" x 27 3/4" x 9 3/4"	225.
1	SA-306/SRT-3A	9 1/2" x 7 1/2" x 6 1/2"	15.
1	T-397/SRT-4A	45 3/16" x 13 1/4" x 19 1/2"	360.

**TUBES, CRYSTALS, TRANSISTORS:**

**REFERENCE DATA AND LITERATURE:**

TM 11-852.

RADIO TRANSMITTING SET  
AN/SRT-10( )

1 March 1964

Cog. Serv.: USA FSN: 5820-222-0059

USA Line Item No: 657990

	USA	USN	USAF	USMC
STATUS OR TYPE CLASS.:	Std B		L/Std	

Manufacturer: A. F. Smuckler &amp; Co., Inc.

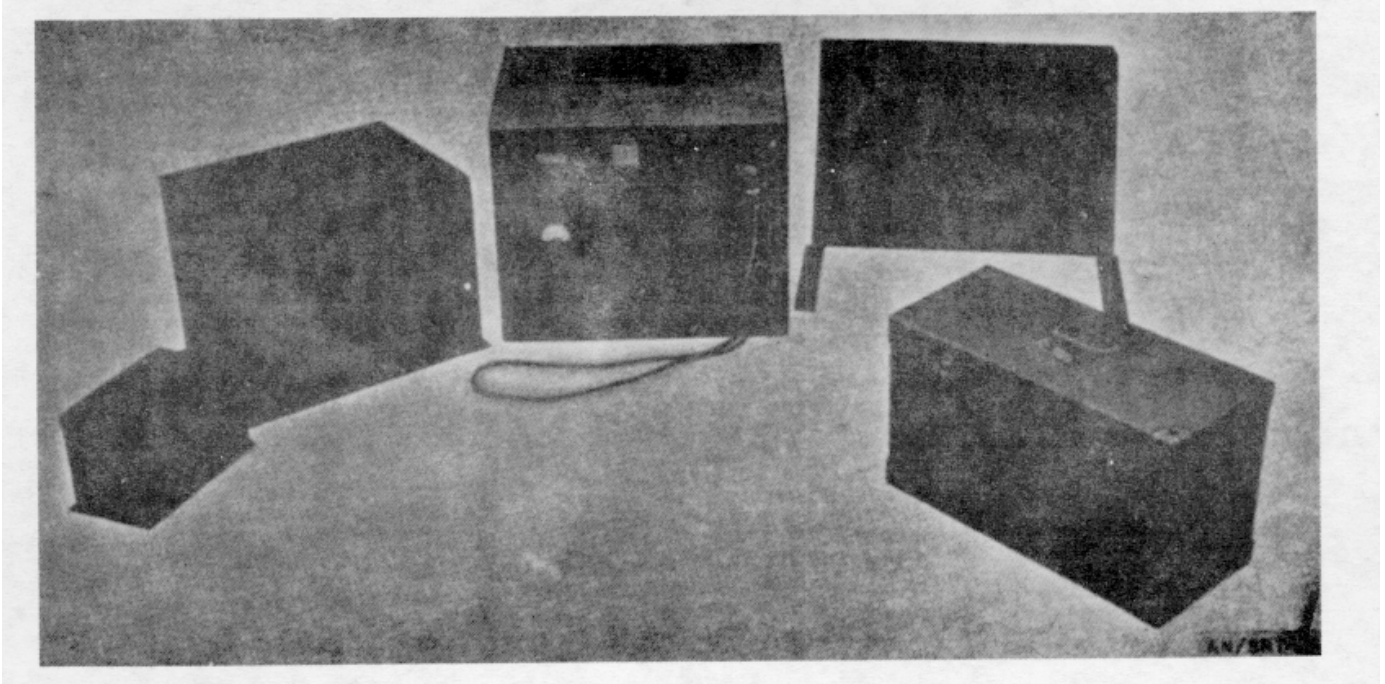
**FUNCTIONAL DESCRIPTION:**

Radio Transmitting Set AN/SRT-10( ) is a 50-watt am (cw, voice) marine telephone and telegraph radio transmitter used on small ships. Provisions are included for its operation by remote control.

This set operates from a 115-volt ac or a 24-, 32-, or 110-volt dc source. When operating from the dc source, a motor starter and a suitable converter (not supplies) must be used.

This equipment is functionally identical with Radio Transmitter T-83/SR.

**RELATIONSHIP TO SIMILAR EQUIPMENT:****TECHNICAL DESCRIPTION:**

*Frequency Range in mc:* 1.7 to 8.7.

*Type Modulation:* am.

*Type of Signal:* Cw, voice.

*Power Output:* 50 w.

*Power Requirements:* 450 w, 115-v 50/60-cy ac; or 500 w, 24/32/110-v dc.

*Major Units:*

1	RE-79/SRT-10	10 1/2" x 6 1/8" x 6 1/16".
1	PP-462/U	18" x 15 3/4" x 13 1/2".
1	T-240/SRT-10	20 3/4" x 17 3/4" x 17 7/8".

**RADIO TRANSMITTING SET  
AN/SRT-10( )**

**TUBES, CRYSTALS, TRANSISTORS:**

**REFERENCE DATA AND LITERATURE:**

TM 11-837.

**ANTENNA COUPLER**  
**AN/SRT-type**  
**CU-731/SRT; CU-732-SRT**

1 March 1964

Cog. Serv.: USA FSN: 5985-725-8171 (CU-731/SRT)  
 5985-725-8170 (CU-732/SRT)

USA Line Item No:

USA    USN    USAF    USMC

STATUS OR TYPE CLASS.:

Manufacturer: CBUF (81751).

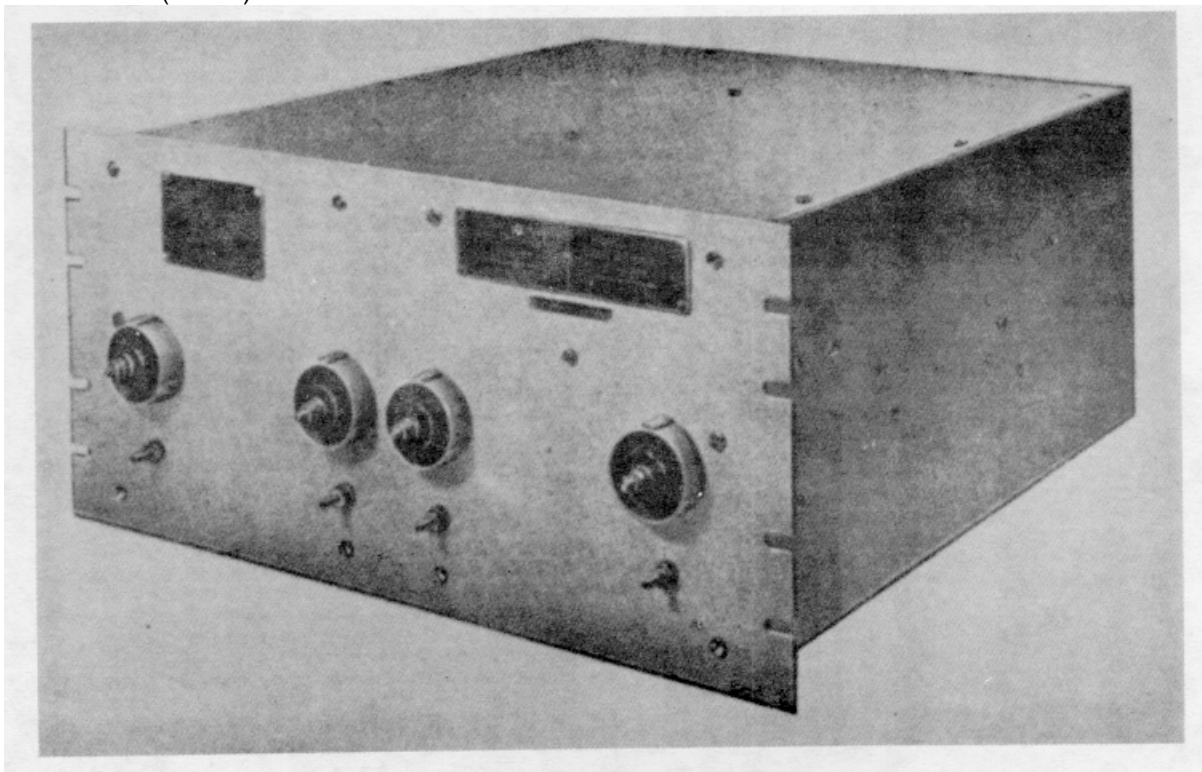

**FUNCTIONAL DESCRIPTION:**

The CU-731/SRT and CU-732/SRT are identical except for frequency crossover range. They are complimentary filters consisting of a low-pass and high-pass network of inductors and capacitors enclosed in an aluminum case which is designed to be mounted standard 19-inch electronic cabinets.

**RELATION TO SIMILAR EQUIPMENT:**

None.

**TECHNICAL DESCRIPTION:**

*Frequency Spectrum:*

A frequency spectrum of 175 kc to 27 mc is covered by either of the networks. Within this spectrum, the area of frequency crossover for each of the units is: CU-731/SRT 2,400 kc or 2,750 kc;

**ANTENNA COUPLER**  
**AN/SRT-type**  
**CU-731/SRT; CU-732/SRT**

CU-732/SRT 3,300 kc or 3,800 kc. Changing the crossover frequency requires changing manually each of the seven inductors in each unit.

*Impedance:* 180 ohms.

*Power Rating:* 50 watts

*Major Units:* 1 ea CU-731/SRT and CU-732/SRT 9" x 19" x 22"

23 lbs.

**TUBES, CRYSTALS, TRANSISTORS:**

**REFERENCE DATA AND LITERATURE:**

CU-731/SRT and CU-732/SRT NAVSHIPS 93527.

**ELECTRICAL FILTER ASSEMBLY**  
**AN/SRT-type**  
**F-160B/SRT**  
**F-161A/SRT**  
**F-162A/SRT**

15 March 1962

Cog. Serv.: USA FSN: 5915-678-192

USA Line Item No:

	USA	USN	USAF	USMC
<b>STATUS OR TYPE CLASS.:</b>	Std A			

**Manufacturer:** Columbus Electronics Corp.

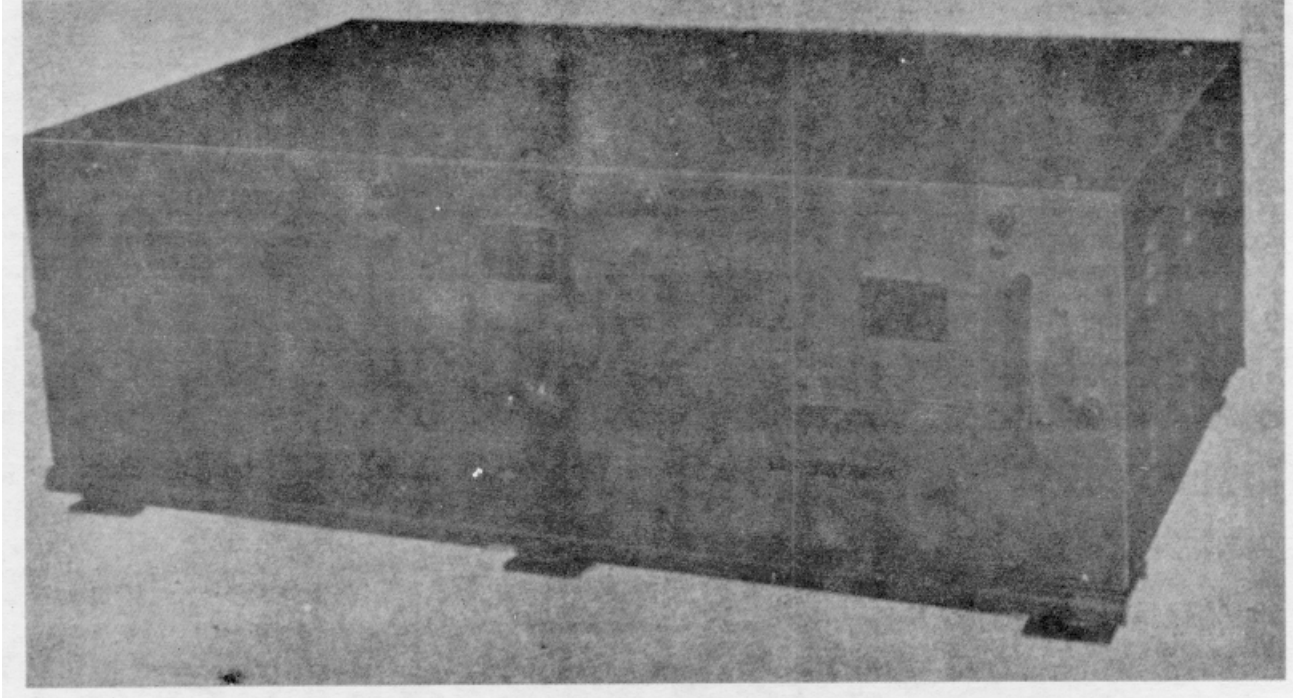

**FUNCTIONAL DESCRIPTION:**

Electrical Filter Assemblies F-160B/SRT, F-161A/SRT, and F-162A/SRT are each used to couple the outputs of two transmitters to one antenna without interaction between transmitters. Each consists of two filters, one high pass and one low pass. In the F-161A/SRT and the F-162A/SRT, there are two crossover points, selectable by a switch on the cabinet; in the F-160B/SRT, there is only one.

The filter assemblies may be cascaded; that is, the output of one may feed into the input to one section of another so that the one antenna is being fed by three transmitters.

**ELECTRICAL FILTER ASSEMBLY**

AN/SRT-type

F-160B/SRT

F-161A/SRT

F-162A/SRT

**RELATION TO SIMILAR EQUIPMENT:**

F-160B/SRT differs from previous models in that Electrical Equipment Cabinet CY-2589/SRT is used instead of CY-1215/SRT. F-161A/SRT and F-162A/SRT differ from their previous models in that Electrical Equipment Cabinet CY-1215A/SRT is used.

**TECHNICAL DESCRIPTION:**

*Frequency Range:* 175 kc to 27 mc.

*Cross Point:*

F-160B/SRT: 1,750 kc.

F-161A/SRT: 3,250 or 3,750 kc.

F-162A/SRT: 6,500 or 7,500 kc.

*Switching Action:* Manual.

*Impedance, Input and Output:* 180 ohms.

*Frequency Range of Filters:*

Low Pass Filter F-175/SRT: 175 kc to 1, 500 kc.

High Pam Filter F-176/SRT: 2,000 kc to 27 me.

Low Pass Filter F-177/SRT: 175 kc to 3,025 or 3, 500 kc.\*

High Pass Filter F-178/SRT: 3,500 or 4,030 kc to 27 mc.

Low Pass Filter F-179/SRT: 175 kc to 6,040 or 7, 000 kc.\*

High Pass Filter F-180/SRT: 7,000 or 8,050 kc\* to 27 mc.

\*(Depends upon setting of frequency crossover switch).

*Power Rating:* 500 watts continuous rating.

*Power Requirements:* None.

*Major Units:*

F-160B/SRT:

1	CY-2589/SRT	17 1/16" x 30 3/4" x 44 1/2"	137 lbs.
1	F-175/SRT	12 1/4" x 19 7/16" x 25 7/8"	50 lbs.
1	F-176/SRT	12 1/4" x 19 7/16" x 25 7/8"	41 lbs.

F-161A/SRT:

1	CY-1215A/SRT	17 1/16" x 30 3/4" x 44 1/2"	137 lbs.
1	F-177/SRT	12 1/4" x 19 7/16" x 25 7/8"	52 lbs.
1	F-178/SRT	12 1/4" x 19 7/16" x 25 7/8"	47 lbs.

F-162A/SRT:

1	CY-1215A/SRT	17 1/16" x 30 3/4" x 44 1/2"	137 lbs.
1	F-179/SRT	12 1/4" x 19 7/16" x 25 7/8"	47 lbs.
1	F-180/SRT	12 1/4"	

**TUBES, CRYSTALS, TRANSISTORS:****REFERENCE DATA AND LITERATURE:**

NAVSHIPS 93739.



RADIO TRANSMITTER  
AN/SRT-type  
T-83/SR

1 March 1964

Cog. Serv.: USA FSN: 5820-164-7149

USA Line Item No: 657660

	USA	USN	USAF	USMC
STATUS OR TYPE CLASS.:	Std C			

**Manufacturer:**

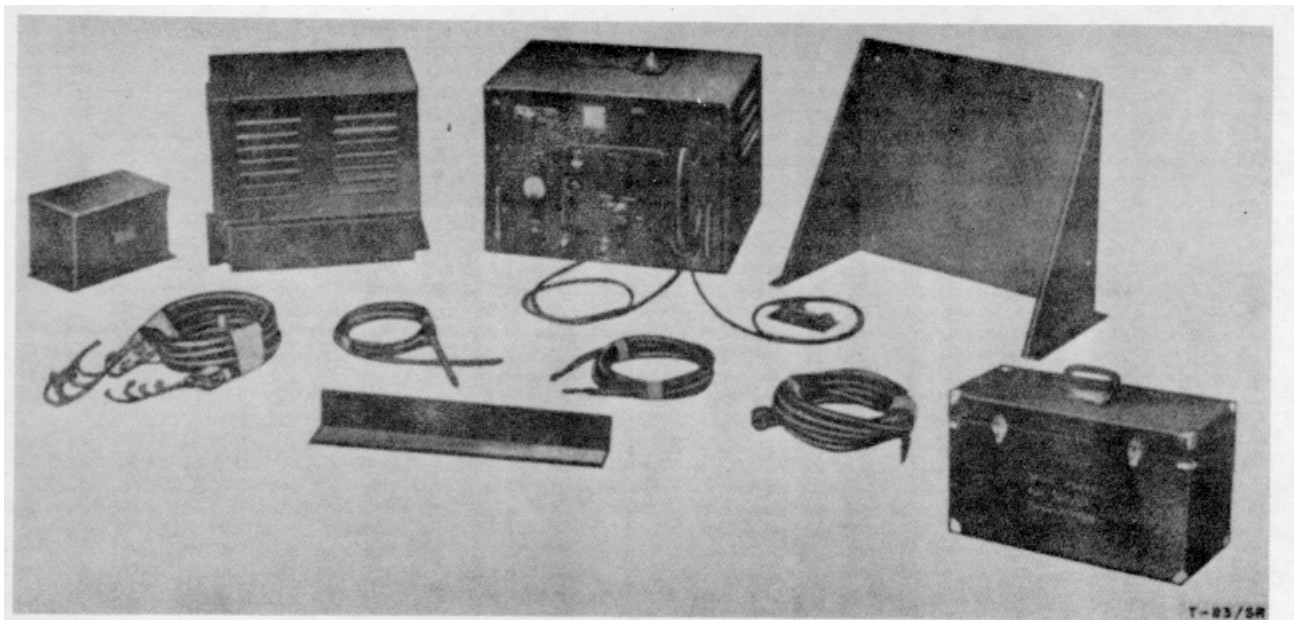

**FUNCTIONAL DESCRIPTION:**

Radio Transmitter T-83/SR is a crystal-controlled short-range, am (voice and cw) transmitting equipment used in two-way, ship-to-shore communication in the medium- and high-frequency range.

This equipment consists of the radio transmitter component and associated power supply and includes a converter starter box and accessories. It operates on five preset frequency channels selected by a five-position switch and can be controlled from a remote operating location.

It uses a long-wire or whip-type antenna and may be table or shelf-mounted.

**RELATIONSHIP TO SIMILAR EQUIPMENT:**

**TECHNICAL DESCRIPTION:**

*Frequency Range in Mc:* 1.7 to 8.7.

*Type Modulation:* am.

*Type of Signal:* Cw and voice.

*Power Output:* 50 w.

*Power Requirements:* 460 w, 115-v 50/60-cy ac.

**RADIO TRANSMITTER**  
**AN/SRT-type**  
**T-83/SR**

*Major Units:*

1	RE-79/SRT-10	6" x 6 1/8" x 10 1/2"	8.5 lbs
1	Power Supply	13 3/8" x 15 1/4" x 18 1/8"	127.0 lbs
1	T-83/SR	13 1/2" x 16" x 21"	118.0 lbs

**TUBES, CRYSTALS, TRANSISTORS:**

**REFERENCE DATA AND LITERATURE:**

TM 11-837.  
(USA) 69-2.

MULTIPLEXER GROUP  
AN/TCA-1

1 March 1964

Cog. Serv.: USA FSN: 5805-309-3342

USA Line Item No: 628320

	USA	USN	USAF	USMC
STATUS OR TYPE CLASS.:			Std	

Manufacturer: International Telephone &amp; Telegraph Corp.

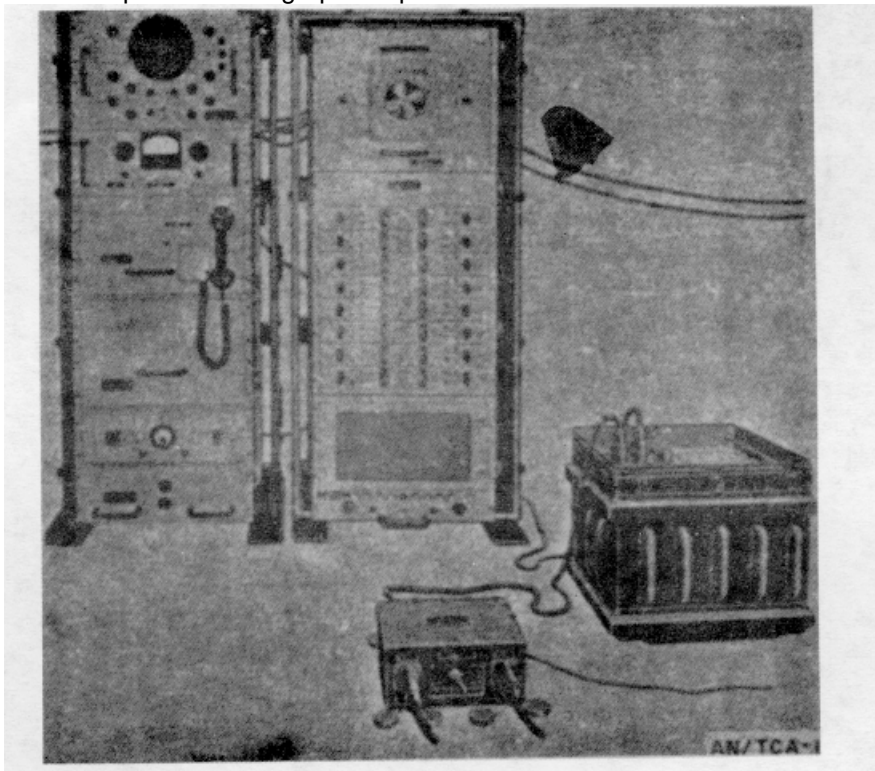
**FUNCTIONAL DESCRIPTION:**

Multiplexer Group AN/TCA-1 is used as a drop and insert terminal at a microwave repeater station in systems using Multiplexer Sets AN/TCC-13 at its terminals.

The AN/TCA-1 provides eight independent vf channels for use in the area of the repeater station at which it is installed. Each of the eight channels can be dropped for local use or passed through the system without change. It also restores the 23- or 45channel video pulse train from the microwave radio receiver into a standard wave shape before it is fed into the microwave radio transmitter.

This equipment is part of Radio Repeater Set AN/TRC-41.

**RELATIONSHIP TO SIMILAR EQUIPMENT:****TECHNICAL DESCRIPTION:**

*Facilities Required:* Radio Set AN/TRC-29 or equivalent.

*Facilities Provided:* Restores pulse train of 23- or 45-channel voice system, and allows up to 8 drop-and-insert voice channels.

*Type of Signal:* Pulse position, time-division multiplex.

**MULTIPLEXER GROUP**  
**AN/TCA-1**

*Frequency (Each of channel):*

Modulating Bandwidth: 300 to 3,500 cps.

Signaling: 20 cps.

*Video Signal Characteristics:*

Pulse Rate: 192 kc.

Pulse Width: 0.6 microsecond.

Bandwidth: 1 mc.

*Power Requirements:* 1.1 kw, 115/230-v ( $\pm 10\%$ ) 47.3-63-cy ac.

*Major Units:*

1	C-1151/TC	19" x 19" x 10 1/2"	
1	MT-1433/TCA-1		
1	MX-1442/TC	19" x 17 1/4" x 8 1/2"	
1	PP-691/G	19" x 19" x 12"	123 lbs.
1	TD-68/G	22 3/4" x 19" x 15 5/8"	
2	C-1509/TC	4 1/2" x 2 3/4" x 5 1/2"	
16	MD-179/TC	16" x 2 3/4" x 8 1/2"	5.5 lbs.
1	CN-236/G	23" x 17 1/2" x 19 1/2"	215 lbs.

**TUBES, CRYSTALS, TRANSISTORS:**

**REFERENCE DATA AND LITERATURE:**

TM 11-2141.  
 TM 11-2682.  
 MIL-R-14267.

TELEPHONE TERMINAL  
AN/TCC-3

1 March 1964

Cog. Serv.: USA FSN: 5805-503-2648

USA Line Item No: 681725

	USA	USN	USAF	USMC
STATUS OR TYPE CLASS.:	Std A		Std	

Manufacturer: Western Electric Co.

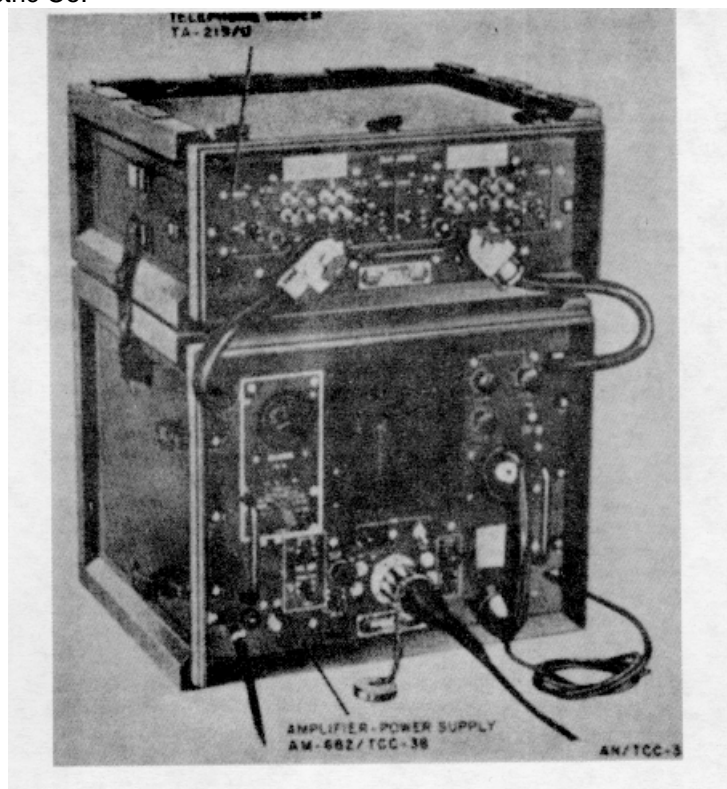
**FUNCTIONAL DESCRIPTION:**

Telephone Terminal AN/TCC-3 is a four-channel carrier telephone terminal set used to provide four traffic channels and one order-wire channel over loaded spiral-four cable. It can also be used to carry a single wide-band special-service channel.

This equipment consists essentially of a telephone modem unit and an amplifier power supply.

This set is the major component of Telephone Terminal AN/TCC-23. It also is used in multiple combinations in Telephone Terminal AN/TCC-7.

**RELATIONSHIP TO SIMILAR EQUIPMENT:****TECHNICAL DESCRIPTION:**

*Facilities Required:* Loaded spiral-four cable or equivalent four-wire facilities

*Facilities Provided:* Four vt traffic channels plus one order-wire channel; or one wide-band channel plus one order-wire channel.

**TELEPHONE TERMINAL  
AN/TCC-3**

*Channel Carrier Frequency:*

- Channel 1: 8 kc.
- Channel 2: 12 kc.
- Channel 3: 16 kc.
- Channel 4: 20 kc.

*Frequency Band:*

- Order wire: 300 to 3,100 cps.
- Channel 1: 4,500 to 7,700 cps.
- Channel 2: 8,500 to 11,700 cps.
- Channel 3: 12,500 to 15,700 cps.
- Channel 4: 16,500 to 19,700 cps.

*Type Modulation:* am; lsb of each channel.

*Type Ringing:* 1,600 cps.

*Power Requirements:* 125 w, 115/230-v 50/60 cy ac.

*Major Units:*

1	AM-682/TCC3	9 1/8" x 18 1/16" x 20 5/8"	73 lbs.
1	TA-219J/U	17 1/16" x 18 1/16" x 20 5/8"	103 lbs.

**TUBES, CRYSTALS, TRANSISTORS:**

**REFERENCE DATA AND LITERATURE:**

- TM 11-2142.
- MIL-T-10485.

TELEGRAPH TERMINAL  
AN/TCC-4

1 March 1964

Cog. Serv.: USA FSN: 5805-537-7387

USA Line Item No: 681695

	USA	USN	USAF	USMC
STATUS OR TYPE CLASS.:	Std A		Std	

Manufacturer: International Telephone &amp; Telegraph Corp.

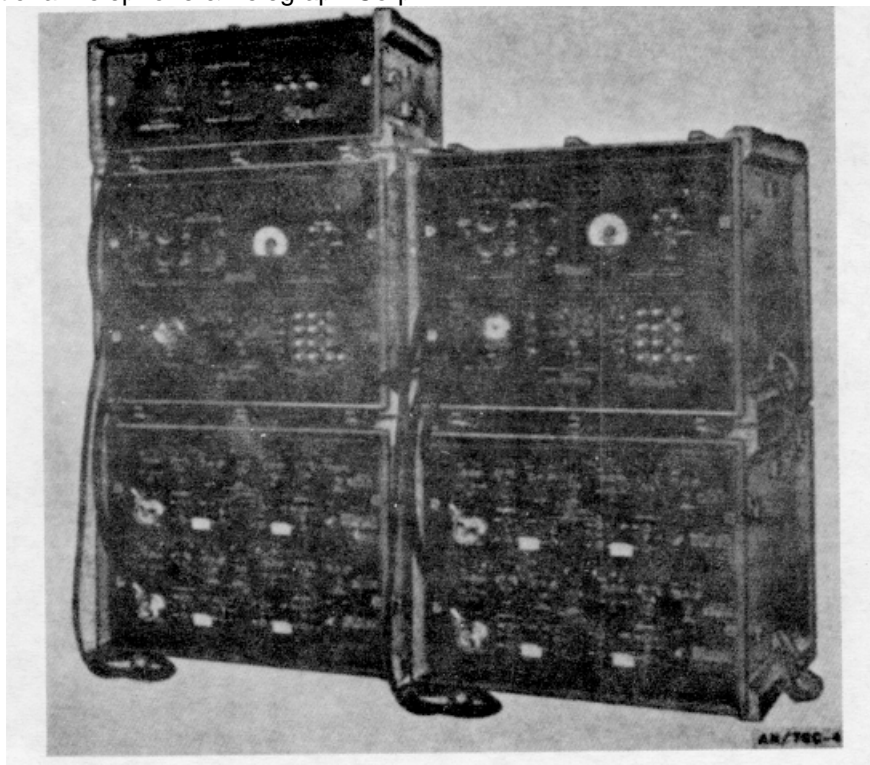
**FUNCTIONAL DESCRIPTION:**

Telegraph Terminal AN/TCC-4 is used for high-speed, frequency-shift, voice-frequency, carrier telegraph communication. It provides terminal equipment for eight teletypewriter channels over a standard two- or four-wire telephone facility, or 16 channels over a four-wire facility.

Different arrangements of this equipment can be made to provide for more or less telegraph channels. Two of these sets can be combined to provide for 16 telegraph channels; or one set can be split to provide two separate four-channel terminals.

This equipment consists essentially of two Telegraph Terminals AN/TCC-20 plus one Telegraph Modem TH-14/T.

**RELATIONSHIP TO SIMILAR EQUIPMENT:**

**TELEGRAPH TERMINAL  
AN/TCC-4**

**TECHNICAL DESCRIPTION:**

*Facilities Required:*

Loops: vf frequency shift teletypewriter signal, 1,325- and 1,225-cps; or dc neutral signal.

Lines: Two- or four-wire telephone channel (wire or radio), flat characteristics between 300 and 3,000 cps.

*Facilities Provided:*

Two-wire line circuits: 8 channels.

Four-wire line circuits: 8 channels or 16 channels.

*Frequency of Line Signals:* 425 to 2,975 cps.

*Type Modulation:* fsk.

*Type Ringing:* 20 cy.

Power Requirements: 480 w, 115/230-v 50-60-cy 1-phase ac.

*Major Units:*

1	TH-14/T	9" x 18 1/8" x 20 5/8"	49 lbs.
2	TH-15/T	16 7/8" x 18 1/8" x 20 5/8"	82 lbs.
2	TH-13/T	16 7/8" x 18 1/8" x 20 5/8"	104 lbs.

**TUBES, CRYSTALS, TRANSISTORS:**

**REFERENCE DATA AND LITERATURE:**

TM 11-2242.  
TO 31W4-2TCC-1.  
MIL-T-10568.



TELEPHONE REPEATER  
AN/TCC-5

1 March 1964

Cog. Serv.: USA FSN: 5805-256-4055

USA Line Item No: 660510

	USA	USN	USAF	USMC
STATUS OR TYPE CLASS.:	Std A		Std	

Manufacturer: Western Electric Co.

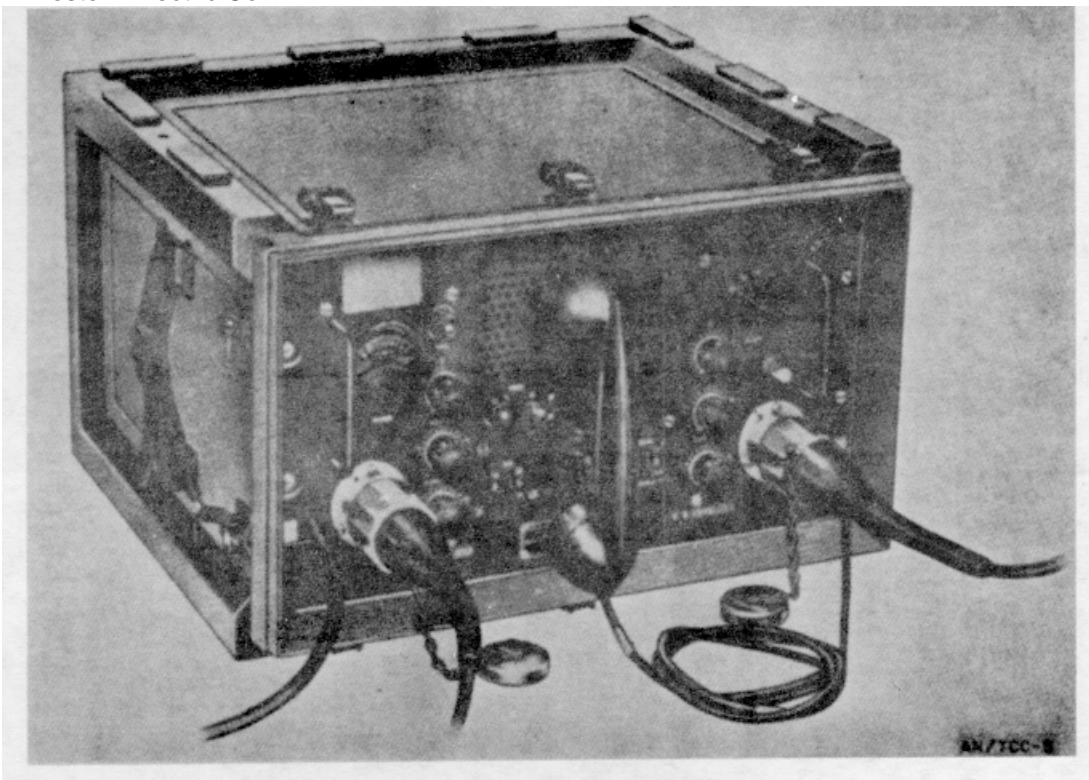
**FUNCTIONAL DESCRIPTION:**

Telephone Repeater AN/TCC-5 is a four-wire carrier telephone repeating equipment specifically designed for use at intermediate points of a system terminated by Telephone Terminal AN/TCC-3 to permit the addition of spiral-four cable sections within a system. It may also be operated with suitable radio terminal equipment in a radio link in such a system.

This equipment consists of a single major operating component that includes provisions for ringing, monitoring, and connection facilities to the order-wire channel of the system.

**RELATIONSHIP TO SIMILAR EQUIPMENT:****TECHNICAL DESCRIPTION:**

*Facilities Required:* Spiral-four cable with Telephone Terminal AN/TCC-3 carrier equipment.

*Facilities Provided:* Four-channel telephone carrier plus one order-wire channel; amplified in both directions

**TELEPHONE REPEATER  
AN/TCC-5**

*Frequency:*

*Carrier Channel:* 4,500 to 19,700 cps.

*Order Wire:* 300 to 3,100 cps.

*Order-wire Signaling:* 1,600 cps.

*Power Requirements:* 115/230-v 50/60-cy ac.

*Major Unit:*

1 AN/TCC-5

12 3/16" x 18 1/16" x 20 5/8"

86 lbs.

**TUBES, CRYSTALS, TRANSISTORS:**

**REFERENCE DATA AND LITERATURE:**

TM 11-2136.

MIL-R-10486.

TELEPHONE TERMINAL  
AN/TCC-7

1 March 1964

Cog. Serv.: USA FSN: 5805-503-1228

USA Line Item No: 681730

	USA	USN	USAF	USMC
STATUS OR TYPE CLASS.:	Std A		Std	

Manufacturer: Western Electric Co.

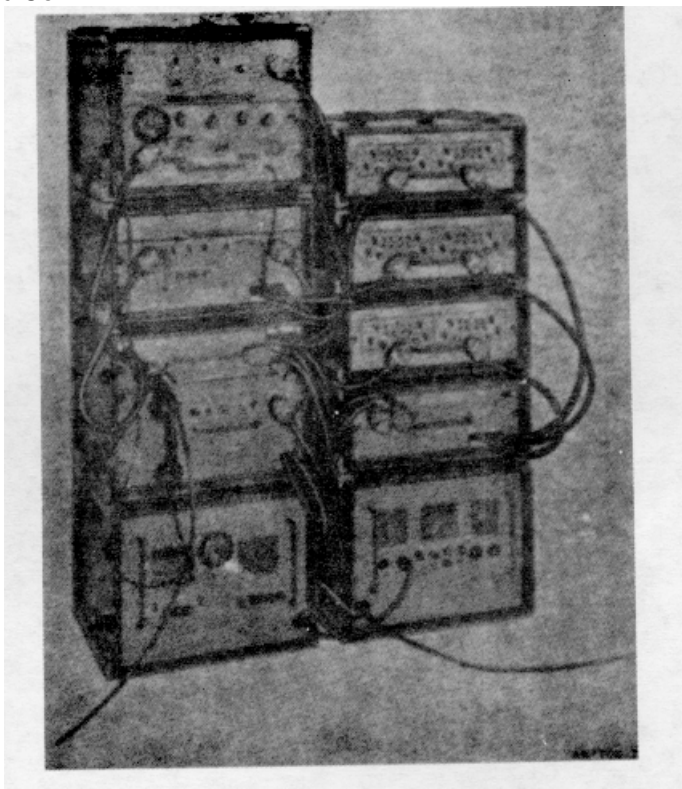
**FUNCTIONAL DESCRIPTION:**

Telephone Terminal AN/TCC-7 is the terminal equipment used in a 12-channel telephone carrier system over a single nonloaded spiral-four cable and/or radio-relay links. This system includes attended Telephone Repeater AN/TCC-8 and unattended Telephone Repeater AN/TCC-11, and can provide two-way telephone communication over 12 vf channels and one order-wire circuit over distance up to 200 miles.

**RELATIONSHIP TO SIMILAR EQUIPMENT:****TECHNICAL DESCRIPTION:**

*Facilities Required:* Nonloaded spiral-four cable or equivalent; appropriate repeater equipment and another AN/TCC-7 terminal at distant end of system.

*Facilities Provided:* 12 vf telephone channel; one order-wire channel; monitoring and ringing facilities.

**TELEPHONE TERMINAL  
AN/TCC-7**

*Frequency:*

Over Spiral-four Cable Alone: 0.3 to 99 kc.

Over Spiral-four Cable and/or Radio Links: 12 to 60 kc.

*Type Modulation:* am.

*Type Ringing:* 1,600 cps.

*Power Requirements:* 710 w, 115/230-v 49-65-cy ac.

*Major Units:*

1	AM-707/TCC-7	17 1/16" x 18 1/16" x 20 5/8"	108 lbs.
1	PP-826/U	17 1/16" x 18 1/16" x 20 5/8"	103 lbs.
1	PP-827/U	17 1/16" x 18 1/16" x 20 5/8"	100 lbs.
1	OA-443/TCC-7	17 1/16" x 18 1/16" x 20 5/8"	83 lbs.

**TUBES, CRYSTALS, TRANSISTORS:**

**REFERENCE DATA AND LITERATURE:**

TM 11-2139.

TELEPHONE REPEATER  
AN/TCC-8

1 March 1964

Cog. Serv.: USA FSN: 5805-333-9796

USA Line Item No: 660647

	USA	USN	USAF	USMC
STATUS OR TYPE CLASS.:	Std A		Std	

Manufacturer: Western Electric Co.

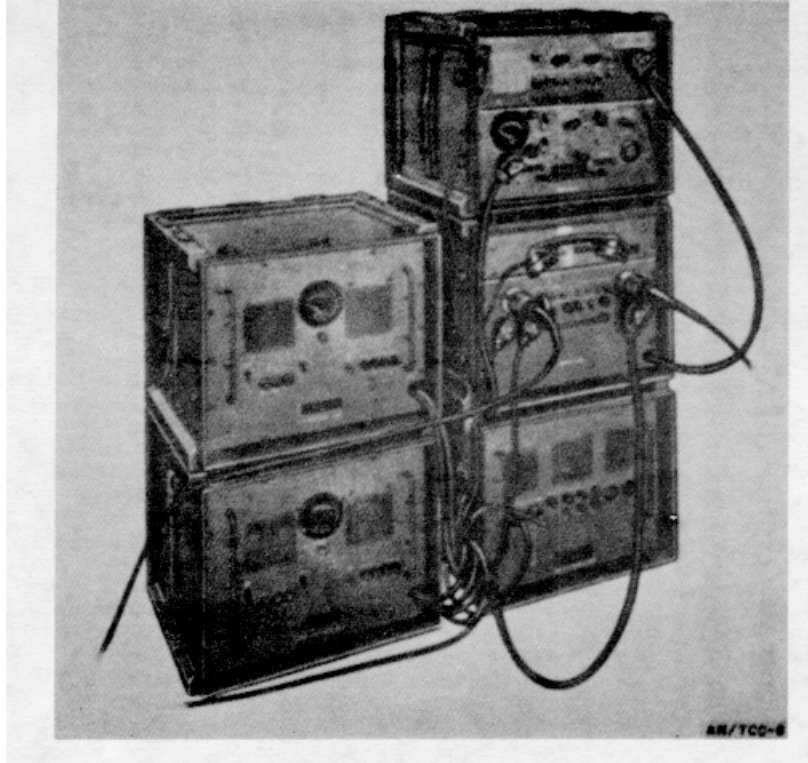
**FUNCTIONAL DESCRIPTION:**

Telephone Repeater AN/TCC-8 is the attended repeater element of a 12-channel carrier telephone system that includes Telephone Terminal AN/TCC-7 and unattended Telephone Repeater AN/TCC-11. Such a system can be operated over nonloaded spiral-four cable and/or radio links for distances up to 200 miles.

This equipment consists of an amplifier, a receiver-transmitter test set group, and two power supplies that also furnish power to one, two, or three unattended repeaters located in the system. A voice-frequency channels and a ringing signal are provided for communication between attended point of the system.

**RELATIONSHIP TO SIMILAR EQUIPMENT:****TECHNICAL DESCRIPTION:**

*Facilities Required:* Single nonloaded spiral-four cable with Telephone Terminal AN/TCC-7 and/or radio links.

**TELEPHONE REPEATER  
AN/TCC-8**

*Facilities Provided:* 12-channel telephone carrier plus one vf order-wire channel, amplified in both directions.

*Frequency:*

Carrier Channel: 12 to 60 kc (pilot frequency, 68 kc; test frequency, 83, 91, 99 kc).

Order-Wire Channel: 300 to 1, 700 cps.

Order-Wire Ringing: 1, 600 cps.

*Power Requirements:* 900 w, 115/230-v 50/60-cy 1-phase ac.

*Major units:*

1	AM-708/TCC-8	17 1/16, " x 18 1/16" x 20 5/8"	118 lbs.
2	PP-826/U	17 1/16" x 18 1/16" x 20 5/8"	103 lbs.
1	PP-827/U	17 1/16" x 18 1/16" x 20 5/8"	100 lbs.
1	OA-446/TCC-8	17 1/16" x 18 1/16" x 50 5/8"	87 lbs.

**TUBES, CRYSTALS, TRANSISTORS:**

**REFERENCE DATA AND LITERATURE:**

TM 11-2140.  
TM 11-2150.  
MIL-R-10624.

TELEPHONE REPEATER  
AN/TCC-11( )

1 March 1964

Cog. Serv.: USA FSN: 5805-356-2661

USA Line Item No: 660650

	USA	USN	USAF	USMC
STATUS OR TYPE CLASS.:	Std A		Std	

Manufacturer: Western Electric Co.

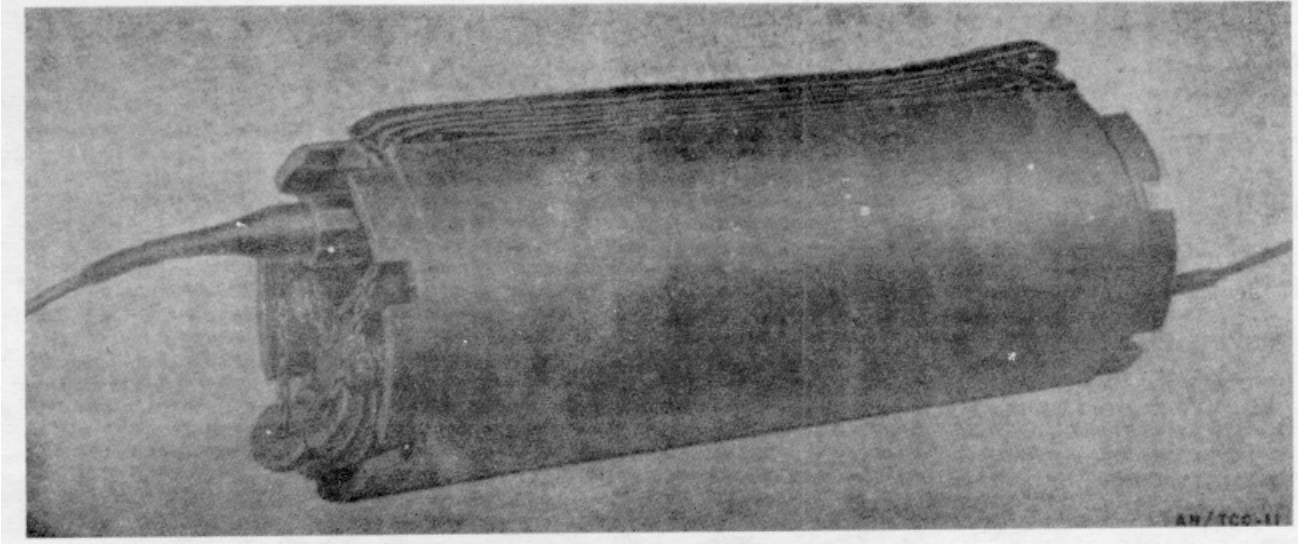
**FUNCTIONAL DESCRIPTION:**

Telephone Repeater AN/TCC-11( ) is a four-wire, unattended, carrier-telephone repeater. It is used to extend the length of a 12-channel spiral-four carrier-telephone system that uses Telephone Terminals AN/TCC-7 and attended Telephone Repeaters AN/TCC-8. The extension obtained for each AN/TCC-11( ) added to the system is 5% miles.

This equipment contains facilities for amplifying, equalizing, and regulating the two-way transmission of a band of frequencies from 12 to 99 kc. This band contains 12 carrier-frequency message channels, a 68-kc pilot frequency, and three fault-finding frequencies of 83 kc, 91 kc, and 99 kc. Amplification is supplied to overcome cable loss at the various frequencies transmitted; regulation is applied to correct for changes in cable loss that occur with changes in temperature.

In addition, a means of ringing, talking, and listening at attended points is provided over an unamplified voice-frequency order-wire circuit.

**RELATIONSHIP TO SIMILAR EQUIPMENT:****TECHNICAL DESCRIPTION:**

*Facilities Required:* Spiral-four cable; 12-channel carrier telephone system using Telephone Terminal AN/TCC-7 and Telephone Repeater AN/TCC-8.

*Facilities Provided:* Amplification of signal in both directions.

*Power Requirements:* 0.1 amp at 150-v regulated dc supplied over spiral-four cable by Telephone Terminal AN/TCC-7 or Telephone Repeater AN/TCC-8.

*Major Unit:* AN/TCC- 11 28 1/4" long x 10" dia

70 lbs.

TELEPHONE REPEATER  
AN/TCC-11( )

TUBES, CRYSTALS, TRANSISTORS:

REFERENCE DATA AND LITERATURE:

TM 11-2148; TM 11-2150.  
MIL-R-10622.



MULTIPLEXER SET  
AN/TCC-13

1 March 1964

Cog. Serv.: USA FSN: 5805-503-1040

USA Line Item No: 628330

	USA	USN	USAF	USMC
STATUS OR TYPE CLASS.:	Std A		Std	

Manufacturer: International Telephone &amp; Telegraph Corp.

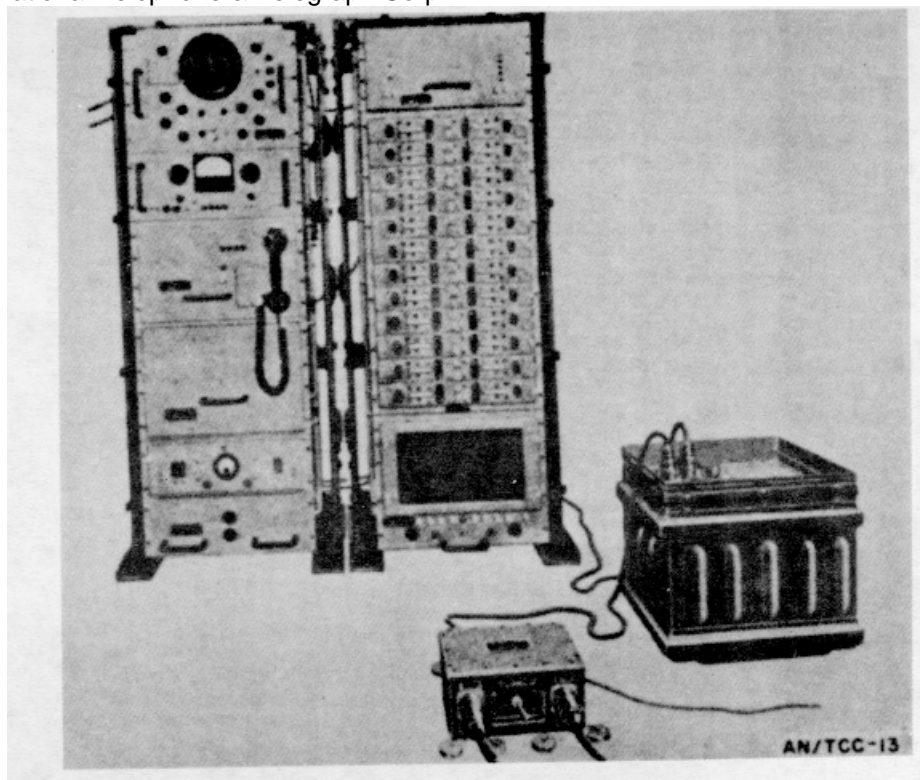
**FUNCTIONAL DESCRIPTION:**

Multiplexer Set AN/TCC-13 is used as a terminal in a multichannel microwave radio-relay communication network.

It combines 23 independent vf channels into one composite video signal for transmission over a single rf carrier; conversely, it separates a video signal into 23 individual vf channels.

Two of these sets at each end of the microwave system can provide 45 individual vf channels.

This set can be used only with manual telephone switching centrals; it can operate with either two-wire or four-wire lines for each of the 23 or 45 channels.

This equipment is a component part of Radio Telephone Terminal AN/TRC-38.

**RELATIONSHIP TO SIMILAR EQUIPMENT:****TECHNICAL DESCRIPTION:**

*Facilities Required:* Radio Set AN/TRC-29 or equivalent.

*Facilities Provided:* Combines 23 vf channels into 1 video channel.

*Type of Signal:* Pulse, position, time-division multiplex

**MULTIPLEXER SET  
AN/TCC-13**

*Frequency (Each of channel):*

Modulating Bandwidth: 300 to 3,500 cps.

Signaling: 20 cps.

*Video Signal Characteristics:*

Pulse Rate: 192 kc.

Pulse Width: 0.6  $\mu$ sec.

Bandwidth: 1 mc.

*Power Requirements:* 1.1 kw, 115/230-v ( $\pm 10\%$ ) 47.5-63-cy ac.

*Major Units:*

1	C-1151/TC	19" x 19" x 10 1/2"	
1	MT-1165/TCC-13	19" x 19" x 31 1/2"	*535 lbs.
			*534
1	MX-1442/TC	19" x 17 1/4" x 8 1/2"	
1	TD-60/TCC-13	19" x 19" x 8 3/4"	
1	PP-691/G	19" x 19" x 12"	123 lbs.
2	C-1509/TC	4 1/2" x 2 3/4" x 5 1/2"	
24	MD-179/TC	16" x 2 1/2" x 8 1/2"	5.5 lbs.
1	CN-236/G	23" x 17 1/2" x 19 1/2"	215 lbs.

(\*Includes case)

**TUBES, CRYSTALS, TRANSISTORS:**

**REFERENCE DATA AND LITERATURE:**

TM 11-2147; TM-11-2682.

MIL-R-14182.

TELEGRAPH-TELEPHONE TERMINAL  
AN/TCC-14

1 March 1964

Cog. Serv.: USA FSN: 5805-238-9873

USA Line Item No: 681715

	USA	USN	USAF	USMC
STATUS OR TYPE CLASS.:	Std A		Std	

Manufacturer: General Dynamics Corp.

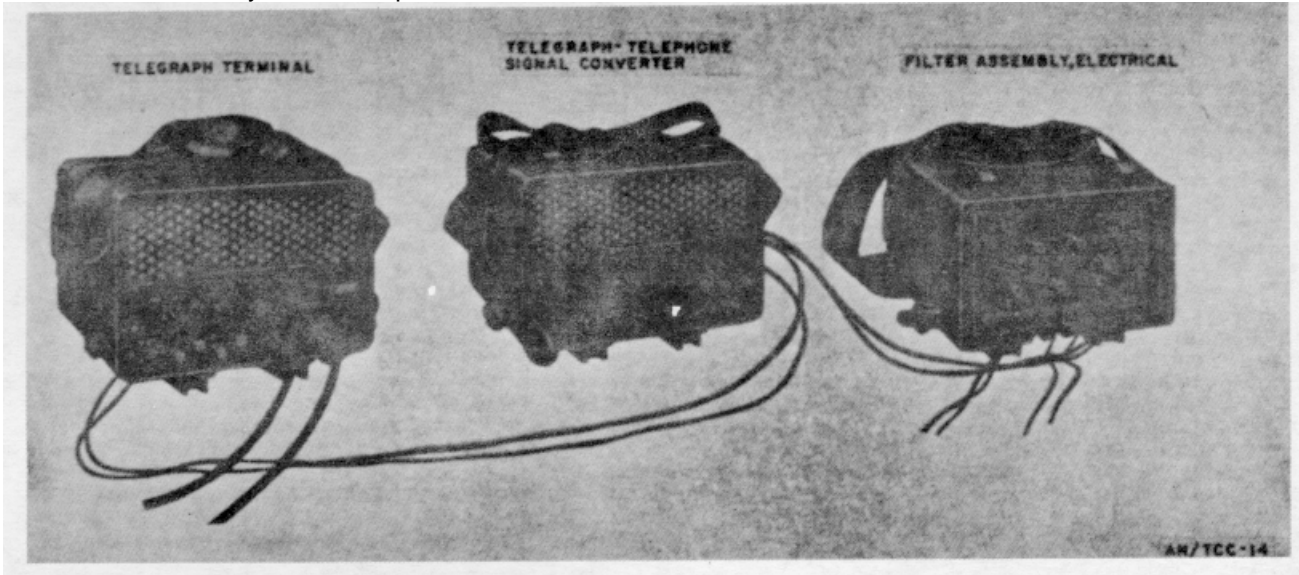
**FUNCTIONAL DESCRIPTION:**

Telegraph-Telephone Terminal AN/TOC-14 is an assemblage of three separate operating components that permits simultaneous transmission of telegraph pulses and speech.

This equipment can be operated in four different types of systems: point-to-point, networks connecting three or more teletypewriter stations, switched systems serving several teletypewriter stations, and push-to-talk remote control radio applications.

It is used in systems composed of two-wire, four-wire, carrier or voice-frequency telegraph facilities, and includes components enabling normal telephone ringing and supervision required for both local battery and common battery switchboards.

**RELATIONSHIP TO SIMILAR EQUIPMENT:****TECHNICAL DESCRIPTION:**

*Facilities Required:* Two-wire or four-wire vf carrier and/or radio remote control circuits.

*Facilities Provided:* Alternate telegraph and telephone; simultaneous telegraph and telephone; speech plus half-duplex; push-to-talk radio control; and/or telegraph only.

*Frequency:*

Telegraph terminal: Mark, 1,325 cps; space, 1,225 cps.

Electrical filter assembly: 1,275 cps (midfrequency).

*Type Ringing:* 20 cps

*Power Requirements:* 115-v (+ 10%) 50/60-cy ac.

**TELEGRAPH-TELEPHONE TERMINAL  
AN/TCC-14**

*Major Units:*

1	F-98/U	10" x 8 3/4" x 6 1/2"	25.5 lbs.
1	TA-182/U	11" x 10 1/2" x 7 1/2"	15 lbs.
1	TH-5/TG	11" x 10 1/2" x 7 1/2"	18.5 lbs.

**TUBES, CRYSTALS, TRANSISTORS:**

**REFERENCE DATA AND LITERATURE:**

TM 11-2239.  
MIL-T-10267.

TELEGRAPH TERMINAL  
AN/TCC-20

1 March 1964

Cog. Serv.: USA FSN: 5805-338-4451

USA Line Item No: 681699

	USA	USN	USAF	USMC
STATUS OR TYPE CLASS.:	Std A		Std	

Manufacturer: General Dynamics Corp.

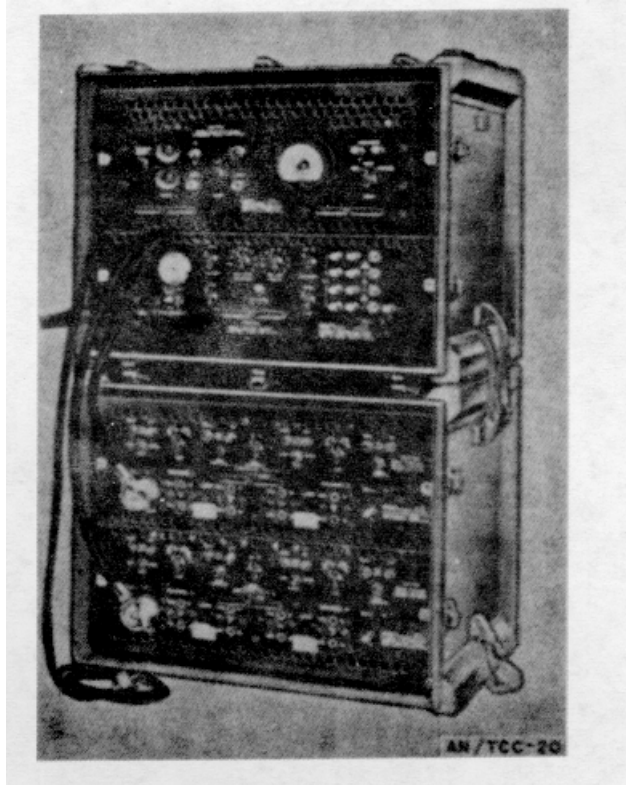
**FUNCTIONAL DESCRIPTION:**

Telegraph Terminal AN/TCC-20 is used for high-speed, frequency-shift, voice-frequency, carrier telegraph communication. It provides terminal equipment for four teletypewriter channels over a standard two- or four-wire telephone facility. Two of these sets, plus a Telegraph Modem TH-14/T make up Telegraph Terminal AN/TCC-4.

In various combinations with Telegraph Terminal AN/TCC-4, a maximum of 16 teletypewriter channels may be obtained on a four-wire line basis.

**RELATIONSHIP TO SIMILAR EQUIPMENT:****TECHNICAL DESCRIPTION:***Facilities required:*

Loops: vf frequency shift teletypewriter signal, 1,325- and 1,225-cps; or dc neutral signal.

Lines: Two- or four-wire telephone channel (wire or radio), fiat characteristics between 300 and 3,000 cps.

**TELEGRAPH TERMINAL  
AN/TCC-20**

*Facilities Provided:* Four-channel, two- or four-wire line operation.

*Frequency of Line Signals:* 425 to 1,615 cps.

*Type Ringing:* 20 cy.

*Power Requirements:* 240 w, 115/230-v 50/60-cy 1-phase ac.

*Major Units:*

1	TH-15/T	16 7/8" x 18 1/8" x 20 5/8"	82 lbs.
1	TH-13/T	16 7/8" x 18 1/8" x 20 5/8"	104 lbs.

**TUBES, CRYSTALS, TRANSISTORS:**

**REFERENCE DATA AND LITERATURE:**

TM 11-2242.

MIL-T-10568.

TELEPHONE REPEATER  
AN/TCC-21

1 March 1964

Cog. Serv.: USA FSN: 5805-692-6777

USA Line Item No: 660657

	USA	USN	USAF	USMC
STATUS OR TYPE CLASS.:	Std A		Std	

**Manufacturer:**

For illustration, see AN/TCC-8, page 567

**FUNCTIONAL DESCRIPTION:**

Telephone Repeater AN/TCC-21 is the attended repeater element of a 12-channel carrier telephone system that includes Telephone Terminal AN/TCC-7 and unattended Telephone Repeater AN/TCC-11. Such a system can be operated over nonloaded spiral-four cable and/or radio link for distances up to 200 miles.

This equipment consists essentially of one Telephone Repeater AN/TCC-8 plus power units and accessory equipment.

**RELATIONSHIP TO SIMILAR EQUIPMENT:****TECHNICAL DESCRIPTION:**

*Facilities Required:* Single nonloaded spiral-four cable with Telephone Terminal AN/TCC-7 and/or radio links.

*Facilities Provided:* 12-channel telephone carrier plus one vf order-wire channel, amplified in both directions.

*Frequency:*

Carrier Channel: 12 to 80 kc (pilot frequency, 68 kc; test frequency, 83, 91, 99 kc).

Order-Wire Channel: 300 to 1,700 cps.

Order-Wire Ringing: 1,600 cps.

*Power Requirements:* 900 w, 115/230- 50/60-cy 1-phase ac.

*Major Unit:*

1	JB-110	2 1/4" x 4 1/2" x 12 1/4"	8.5 lbs.
2	PE-75	26 1/2" x 19" x 36"	330 lbs.

**TUBES, CRYSTALS, TRANSISTORS:****REFERENCE DATA AND LITERATURE:**

TM 11-2140.  
TM 11-2150.  
MIL-R-10624.

TELEPHONE REPEATER  
AN/TCC-22

1 March 1964

Cog. Serv.: USA FSN: 5805-503-1234

USA Line Item No: 660658

	USA	USN	USAF	USMC
STATUS OR TYPE CLASS.:	Std A		Std	

Manufacturer:

For illustration, see AN/TCC-5, page 563

FUNCTIONAL DESCRIPTION:

Telephone Repeater AN/TCC-22 is a four-wire carrier telephone repeating equipment specifically designed for use at intermediate points of a system terminated by Telephone Terminal AN/TCC-3 to permit the addition of spiral-four cable sections within a system. It may also be operated with suitable radio terminal equipment in a radio link in such a system.

This equipment includes provisions for ringing, monitoring, and connection facilities to the order-wire channel of the system.

It is composed essentially of Telephone Repeater AN/T (-5 plus a power unit and accessory items.

RELATIONSHIP TO SIMILAR EQUIPMENT:

TECHNICAL DESCRIPTION:

*Facilities Required:* Spiral-four cable with Telephone Terminal AN/TCC-3 carrier equipment.

*Facilities Provided:* Four-channel telephone carrier plus one order-wire channel, amplified in both directions.

Carrier Channel: 4,500 to 19,700 cps.

Order Wire: 300 to 3,100 cps.

Order-Wire Signaling: 1,600 cps.

*Power Requirements:* 115/230-v 50/60 cy ac.

*Major Units:*

2	PE-214-B	14" x 18 1/2" x 10 <sup>11</sup> "	40 lbs.
1	AN/TCC-5	12 3/16" x 18 1/16" x 20 5/8"	86 lbs.

TUBES, CRYSTALS, TRANSISTORS:

REFERENCE DATA AND LITERATURE:

TM 11-2136.  
MIL-R-10485.



TELEPHONE TERMINAL  
AN/TCC-23

1 March 1964

Cog. Serv.: USA FSN: 5805-338-4452

USA Line Item No: 681735

	USA	USN	USAF	USMC
STATUS OR TYPE CLASS.:	Std A		Std	

**Manufacturer:**

For illustration, see AN/TCC-3, page 559

**FUNCTIONAL DESCRIPTION:**

Telephone Terminal AN/TCC-23 is a four-channel carrier telephone terminal set used to provide four traffic channels and one order-wire channel over loaded spiral-four cable. It can also be used to carry a single wide-band special service channel.

This equipment consists of one Telephone Terminal AN3 plus two power units (one in use, one spare) and accessory items.

**RELATIONSHIP TO SIMILAR EQUIPMENT:****TECHNICAL DESCRIPTION:**

*Facilities Required:* loaded spiral-four cable or equivalent four-wire facilities.

*Facilities Provided:* 4 vf traffic channels plus 1 order-wire channel; or 1 wide-band channel plus 1 order-wire channel.

*Channel Carrier Frequency:*

- Channel 1: 8 kc.
- Channel 2: 12 kc.
- Channel 3: 16 kc.
- Channel 4: 20 kc.

*Frequency Band:*

- Order Wire: 300 to 3,100 cps.
- Channel 1: 4,500 to 7,700 cps.
- Channel 2: 8,500 to 11,700 cps.
- Channel 3: 12,500 to 15,700 cps.
- Channel 4: 16,500 to 19,700 cps.

*Type Modulation:* AM, lower sideband of each channel.

*Type Ringing:* 1,600 cp.

*Power Requirements:* 125 w, 115/230-v 50/60-y ac.

*Major Units:*

2	PE-75	24" x 19" x 36"	330 lbs.
1	AN/TCC-3	26 3/16" x 18 1/16" x 30 5/8"	176 lbs.

**TUBES, CRYSTALS, TRANSISTORS:****REFERENCE DATA AND LITERATURE:**

TM 11-2142.  
MIL-T-10485.

CARRIER HYBRID  
AN/TCC-type  
CF-7

1 March 1964

Cog. Serv.: USA FSN:

USA Line Item No: 608790

	USA	USN	USAF	USMC
STATUS OR TYPE CLASS.:	Obs		L/Std	

Manufacturer: Western Electric Co.



#### FUNCTIONAL DESCRIPTION:

Carrier Hybrid CF-7 is a unit used to connect Telephone Terminal CF-1-A (carrier) or Repeater CF-3-A (carrier), both of which are designed for four-wire operation, to a two-wire line. With this equipment, four two-way telephone circuits can be obtained over a single pair of wires. In addition, two dc ground-return telegraph circuits or one dc signaling circuit and one dc telegraph circuit can be obtained.

This equipment is used primarily with open-wire lines but may also be used on field wire or spiral-four cable.

Four voice-frequency telegraph channels can be made available in place of one of the telephone circuits by applying Telegraph Terminal CF-2-A or CF-2-B (carrier) at the telephone terminals.

#### RELATIONSHIP TO SIMILAR EQUIPMENT

This unit is similar to and interchangeable with Hybrid Circuit Network TA-225/TT.

**CARRIER HYBRID**  
**AN/TCC-type**  
**CF-7**

**TECHNICAL DESCRIPTION:**

*Type of Signal:* Voice, dc telegraph.

*Type Circuit:* Field wire or spiral-four cable.

*Major Units:*

1 CF-7.

18 3/8" x 9 1/2" x 7 3/8"

**TUBES, CRYSTALS, TRANSISTORS:**

**REFERENCE DATA AND LITERATURE:**

TM 11-2003.

WECCO NO. X-66107.

HYBRID CIRCUIT NETWORK  
AN/TCC-type  
TA-31( )/U

1 March 1964

Cog. Serv.: USA FSN: 5915-392-7669

USA Line Item No: 628360

	USA	USN	USAF	USMC
STATUS OR TYPE CLASS.:	Std-A		Std	

Manufacturer: The Daven Co.



**FUNCTIONAL DESCRIPTION:**

Hybrid Circuit Network TA-31( )/U is a portable unit that electrically couples two- and four-wire circuits and permits full-duplex operation in two-wire systems.

This equipment can be used in either wire or radio systems. Provision is made for establishing simplex facilities, signaling, and remote control of radio transmitters, with the use of additional equipment.

**RELATIONSHIP TO SIMILAR EQUIPMENT:**

**TECHNICAL DESCRIPTION:**

*Facilities Required:* Two-wire line facilities, with four-wire equipment.

*Facilities Provided:* Full duplex operation on two-wire lines.

*Frequency:* 250 to 3,200 cps.

*Impedance:* 600 to 4,000 ohms.

**HYBRID CIRCUIT NETWORK**  
**AN/TCC-type**  
**TA-31( )/U**

*Power Requirements:* 115/230-v 50/60-cycle ac, 24-v dc, or Battery BA-419/U.

*Major Unit:*

TA-31( )/U

9" x 11" x 16"

**TUBES, CRYSTALS, TRANSISTORS:**

**REFERENCE DATA AND LITERATURE:**

TM 11-2144.  
MIL-V-10759.

HYBRID CIRCUIT NETWORK  
AN/TCC-type  
TA-255/TT

1 March 1964

Cog. Serv.: USA FSN: 5915-190-5214

USA Line Item No: 628370

STATUS OR TYPE CLASS.:	USA	USN	USAF	USMC
			Std	

Manufacturer: Lenkurt Electric Co., Inc.

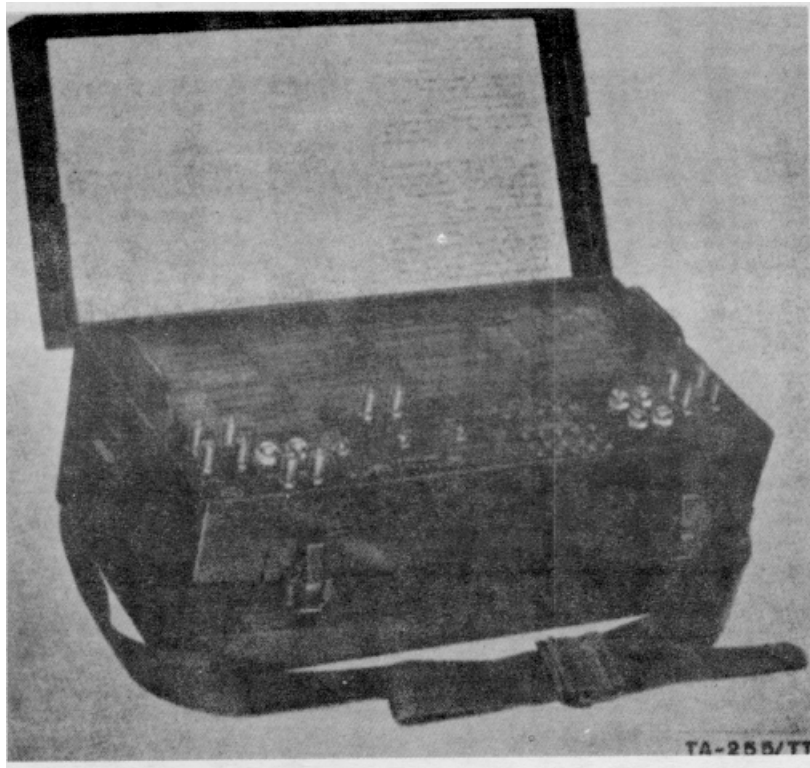

**FUNCTIONAL DESCRIPTION:**

Hybrid Circuit Network TA-255/TT is a portable unit used to connect four-wire line equipment (such as Telephone Terminal CF-1( ) or Repeater CF-3-A) to a two-wire line. It can also be used to connect Radio Terminal Set AN/TRC-3 to a two-wire line.

This equipment will permit operation of a phantom circuit, two ground-return dc telegraph circuits, or one ground-return dc signaling and one ground-return dc telegraph circuit on the two-wire line.

One network is used at each junction of the two-wire and four-wire lines. This equipment is designed for operation over open-wire lines, but in an emergency it may be used on field wire or on one pair of a spiral-four cable system.

**RELATIONSHIP TO SIMILAR EQUIPMENT:**

This unit is similar to and interchangeable with Carrier Hybrid CF-7.

**HYBRID CIRCUIT NETWORK**  
**AN/TCC-type**  
**TA-255/TT**

**TECHNICAL DESCRIPTION:**

*Type of Signal:* dc telegraph and carrier telephone.

*Type of Communication Circuit:* four channel two-way carrier-telephone system; two de telegraph circuits.

*Major Units:*

TA-255/TT

7" x 10" x 18 1/2"

45 lbs.

**TUBES, CRYSTALS, TRANSISTORS:**

**REFERENCE DATA AND LITERATURE:**

TM 11-2003A.

REPEATER SET  
AN/TCC-type  
TC-19

1 March 1964

Cog. Serv.: USA FSN: 5805-194-9449

USA Line Item No: 660600

	USA	USN	USAF	USMC
STATUS OR TYPE CLASS.:	Obs		Std	

Manufacturer:

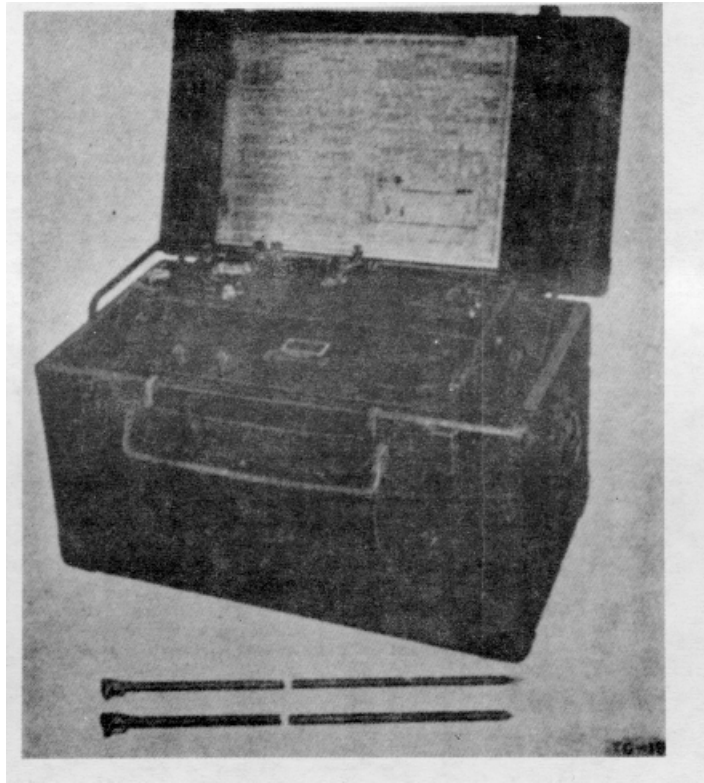

**FUNCTIONAL DESCRIPTION:**

Repeater Set TC-19 is a portable, field, dc telegraph repeater used for single operation at intermediate points between terminal repeater equipment.

This equipment consists essentially of a repeater, contained in a field-type carrying case, and two ground rods. It can repeat signals in either direction, but in only one direction at a time. It provides one channel for telegraph communication on a simplex, or composited, ground-return basis. When used as an intermediate repeater, only one set can be used in the line circuit between two terminal repeaters.

The operating range of Repeater Set TC-18 can be extended by using this equipment.

**RELATIONSHIP TO SIMILAR EQUIPMENT:**



**REPEATER SET**  
**AN/TCC-type**  
**TC-19**

**TECHNICAL DESCRIPTION:**

*Facilities Required:* field wire or open wire; simplex or composit.

*Power Requirements:* 190 w, 95-125/19-250-v 50/60-cycle ac; 115 w, 115-v dc; or 12-v storage battery.

*Major Units:*

2	MX-148/G	72" x 3/4"(dia)	9.5 lbs.
1	TG-31	25" x 16" x 14 1/2"	120 lbs.

**TUBES, CRYSTALS, TRANSISTORS:**

**REFERENCE DATA AND LITERATURE:**

TM 11-2005.

**APPENDIX B  
INDEX OF ITEMS BY TYPE NUMBERS  
(SECOND INCREMENT)**

<i>Item</i>	<i>Page</i>	<i>Item</i>	<i>Page</i>
AN/FRR-3( )-----	237	AN/FTC-Type:	
AN/FRR-10-----	239	B-53( )/FTC-----	321
AN/FRR-12-----	243	8B-4, FTC-----	323
AN/FRR-12X-----	245	sB-5s5/srC-----	325
AN/FRR-26-----	247	8B-56/FTC-----	327
AN/FRR-27-----	249	8B-60/FTC-----	329
AN/FRR-33-----	251	8B-62/FTC-----	331
AN/FRR-34-----	253	8B-63/FTC-----	333
AN/FRR-36-----	255	8B-64/FTC-----	335
AN/FRR-37-----	239	B-171/FTC-----	337
AN/FRR-38( )-----	257	AN/GCA-Type: TA-182/U-----	339
AN/FRR-39-----	259	AN/GGA-Type: TG-10, -10F-----	341
AN/FRR-40, -41-----	261	AN/GGC-3-----	343
AN/FRR-44-----	263	AN/GGC-Type: SB-6( )/GG-----	345
AN/FRR-59-----	265	AN/GIA-Type: AM-65/GRC-----	347
AN/FRR-Type:		AN/GRA-6-----	351
CV-861AFRR-----	267	AN/GRA-11-----	353
R-274/FRR-----	269	ANGRA-14-----	356
R-274A/FRR, R-274C/FRR-----	271	AN/GRA-24-----	357
RC-256-----	273	AN/GRA-Type:	
SCR-244, -A, -B, -C-----	275	AT-249/GRD-----	359
AN/FRT-----	277	GN-58-A-----	361
AN/FRT-15A-----	279	AN/GRC-3-----	363
AN/FRT-17-----	283	AN/GRC-4( )-----	365
AN/FRT-18-----	285	AN/GRC-5-----	367
AN/FRT-22-----	287	AN/GRC-----	369
AN/FRT-24-----	289	AN/GRC-7-----	371
AN/FRT-26-----	291	AN/GRC-8-----	373
AN/FRT-27-----	293	AN/GRC-9( )-----	375
AN/FRT-Type:		AN/GRC 10-----	377
BC-329-( )-----	295	AN/GRC-13-----	379
BC-339-( )-----	297	AN/GRC-19( )-----	381
MW-3-----	299	AN/GRC-26( )-----	383
SCR-643-----	301	AN/GRC-27-----	385
T-4( )/FRC-----	303	AN/GRC-30-----	387
T-5( )/FRC-----	305	AN/GRC-38( )-----	389
T-158( )/FRT-----	307	AN/GRC-39-----	391
T-159/FRT-----	309	AN/GRC-40-----	393
T-171( )/FR-----	311	AN/GRC-46-----	395
T-265/FRC-10-----	313	AN/GRC-75-----	397
T-409/FRC-30-----	315	AN/GRC-76-----	399
TDD, -1, -2, -3, -4-----	317	AN/GRC-77-----	401
AN/FSH-Type: RD-41B/U-----	319	AN/GRC-78-----	403

<i>Item</i>	<i>Page</i>
AN/GRC-80 -----	405
AN/GRC-81 -----	407
AN/GRC-82 -----	409
AN/GRD-5 -----	411
AN/GRR-5( ) -----	413
AN/GRR-7 -----	415
AN/GRR-Type:	
R-361C/GR -----	417
SCR-607-( ) -----	419
AN/GRT-2 -----	421
AN/GRT-3 -----	423
AN/GRT-Type:	
BC-610-( ) -----	425
T-417/GR -----	427
AN/GSC-T1-( ) -----	429
AN/GTA-Type: TA-126/GT -----	431
AN/GTC-Type: TP-14 -----	433
AN/GTT-Type: OA-145/GT -----	435
AN/MRC-2( ) -----	437
AN/MRC-5, -5C -----	439
AN/MRC-5B, -6B, -7B, -8B -----	441
AN/MRC-6C -----	443
AN/MRC-20 -----	445
AN/MRC-40 -----	447
AN/MRC-41 -----	449
AN/MRC Type:	
AT-1101/U -----	451
SCR-399 -----	453
AN/MRR-4( ) -----	455
AN/MRR-5 -----	457
AN/MRR-6 -----	459
AN/MRT-5( ) -----	461
AN/MRT- -----	463
AN/MRT-7 -----	465
AN/MRT-Type:	
SCR-573-( ) -----	467
T-208/U -----	469
AN/MTC-Type: 8100/MTC -----	471
AN/MTQ-1( ) -----	473
AN/PGC-1 -----	475
AN/IPP-1A -----	477
AN/PIQ-1 -----	479
AN/PIQ-2 -----	481
AN/PIQ-5 -----	483
AN/PNH-Type: RD-31A/U -----	485
AN/PRC-6( ) -----	487
AN/PRC-8 -----	489
AN/PRC-9( ) -----	491
AN/PRC-10( ) -----	493
AN/PRC-21( ) -----	495
AN/PRC-37 -----	497
AN/PRC-, 41(XN-2) -----	499

<i>Item</i>	<i>Page</i>
AN/PRC-Type:	
May 1 -----	501
SCR-300 -----	505
AN/PRW-Type: RC-261 -----	507
AN/PTA-1 -----	509
AN/PTC-Type:	
SB-22( )/PT -----	511
SB-86/P -----	513
AN/PVC-Type: SE-11 -----	515
AN/SRA-17B -----	517
AN/SRA-28 -----	519
AN/SRA-Type: AS-390/SRC -----	521
AN/SRC-6( ) -----	523
AN/SRC-7 -----	525
AN/SRC-8( ) -----	527
AN/SRC-9 -----	529
AN/RC-20 -----	531
AN/SRC-21 -----	535
AN/SRC-Type:	
O-44/SRC -----	537
O-792/SRC -----	537
SCR-281-( ) -----	539
AN/SRR-Type:	
R-96( )/SR -----	541
R-212/SR -----	543
AN/SRT-3( ) -----	545
AN/SRT-4( ) -----	547
AN/SRT-10( ) -----	549
AN/SRT-Type:	
CU-731/SRT, CU-732/SRT -----	551
F-160B/SRT, F-161A/SRT, F-162A/SRT -----	563
T-83/SR -----	555
AN/TCA-1 -----	557
AN/TCC-3 -----	559
AN/TCC-4 -----	561
AN/TCC-5 -----	563
AN/TCC-7 -----	565
AN/TCC-8 -----	567
AN/TCC-11( ) -----	569
AN/TCC-13 -----	571
AN/TCC-14 -----	573
AN/TCC-20 -----	575
AN/TCC-21 -----	577
ANiTCC-22 -----	579
ANTCC-23 -----	581
AN/TCC-Type:	
CF-7 -----	583
TA-31( )/U -----	585
TA-255/TT -----	587
TC-19 -----	589
AN/WRR-2 -----	265

Custodians:  
Army-EL  
Navy-BuShips  
Air Force-AF-85  
User activities:  
Army-MO, MU

Preparing activity:  
Army-EL  
Project No. MISC-0138

☆U.S. GOVERNMENT PRINTING OFFICE: 1990 0-261-872 (20733)



**PIN: 010437-000**